

Owner's Manual
for Vehicle



The Ultimate
Driving Machine



M3 Owner's Manual for Vehicle

Congratulations, and thank you for choosing a BMW M3.

Thorough familiarity with your vehicle will provide you with enhanced control and security when you drive it. We therefore have this request:

Please take the time to read this Owner's Manual and familiarize yourself with the information that we have compiled for you before starting off in your new vehicle. It contains important data and instructions intended to assist you in gaining maximum use and satisfaction from your BMW M3's unique range of technical features. The manual also contains information on maintenance designed to enhance operating safety and contribute to maintaining the value of your BMW M3 throughout an extended service life.

This manual is supplemented by a Service and Warranty Information Booklet for US models or a Warranty and Service Guide Booklet for Canadian models.

We wish you an enjoyable driving experience.

BMW AG

© 2008 Bayerische Motoren Werke
Aktiengesellschaft
Munich, Germany
Reprinting, including excerpts, only with the
written consent of BMW AG, Munich.
Order No. 01 41 0 014 962
US English II/08, 08 03 500
Printed in Germany
Printed on environmentally friendly paper,
bleached without chlorine, suitable for recycling.

Contents

The fastest way to find information on a particular topic or item is by using the index, refer to page [256](#).

Using this Owner's Manual

- [4](#) Notes
- [6](#) Reporting safety defects

At a glance

- [10](#) Cockpit
- [16](#) iDrive
- [23](#) Voice command system

Controls

- [28](#) Opening and closing
- [45](#) Adjustments
- [57](#) Transporting children safely
- [59](#) Driving
- [73](#) Everything under control
- [87](#) Technology for driving comfort and safety
- [99](#) Lamps
- [103](#) Climate
- [109](#) Practical interior accessories

Driving tips

- [124](#) Things to remember when driving
- [129](#) BMW M3 engineering

Navigation

- [134](#) Starting the navigation system
- [136](#) Destination entry
- [149](#) Destination guidance
- [158](#) What to do if ...

Entertainment

- [162](#) On/off and settings
- [166](#) Radio
- [172](#) Satellite radio
- [175](#) CD player and CD changer
- [181](#) AUX-In port
- [182](#) USB-audio interface

Communications

- [188](#) Telephoning
- [203](#) BMW Assist

Mobility

- [214](#) Refueling
- [216](#) Wheels and tires
- [222](#) Under the hood
- [227](#) Maintenance
- [229](#) Care
- [233](#) Replacing components
- [241](#) Giving and receiving assistance

Reference

- [248](#) Technical data
- [252](#) Short commands for the voice command system
- [256](#) Everything from A-Z

Notes

Using this Owner's Manual

We have tried to make all the information in this Owner's Manual easy to find. The fastest way to find specific topics is to refer to the detailed index at the back of the manual. If you wish to gain an initial overview of your vehicle, you will find this in the first chapter.

Should you sell your BMW some day, please remember to hand over the Owner's Manual as well; it is an important component of your vehicle.

Additional sources of information

Should you have any other questions, your BMW center will be glad to advise you at any time.

Information on BMW, e.g. on technical aspects, can also be found on the Internet at www.bmwusa.com.

Symbols used

 Indicates precautions that must be followed precisely in order to avoid the possibility of personal injury and serious damage to the vehicle. ◀

 Indicates information that will assist you in gaining the optimum benefit from your vehicle and enable you to care more effectively for your vehicle. ◀

 Refers to measures that can be taken to help protect the environment. ◀

◀ Marks the end of a specific item of information.

* Indicates special equipment, country-specific equipment and optional extras, as well as equipment and functions not yet available at the time of printing.

"..." Identifies Control Display texts used to select individual functions.

›...‹ Verbal instructions to use with the voice command system.

››...‹‹ Identifies the answers generated by the voice command system.

Symbols on vehicle components

 Indicates that you should consult the relevant section of this Owner's Manual for information on a particular part or assembly.

The individual vehicle

When you ordered your BMW, you chose various items of equipment. This Owner's Manual describes the entire array of options and equipment available with a specific BMW model.

Please bear in mind that the manual may contain information on accessories and equipment that you have not specified for your own vehicle. Sections describing options and special equipment are marked by asterisks * to assist you in identifying possible differences between the descriptions in this manual and your own vehicle's equipment.

If equipment in your BMW is not described in this Owner's Manual, please refer to the accompanying Supplementary Owner's Manuals.

Editorial notice

BMW pursues a policy of continuous, ongoing development that is conceived to ensure that our vehicles continue to embody the highest quality and safety standards combined with advanced, state-of-the-art technology. For this reason, it is possible in exceptional cases that features described in this Owner's Manual could differ from those on your vehicle.

For your own safety

Maintenance and repair



Advanced technology, e.g. the use of modern materials and powerful electronics, requires specially adapted maintenance and repair methods. You should therefore have the corresponding work on your vehicle performed only by your BMW center or at a workshop that works according to BMW repair procedures with correspondingly trained personnel. If this work is not carried out properly, there is a danger of subsequent damage and related safety hazards. ◀

Parts and accessories



For your own safety, use genuine parts and accessories approved by BMW.

When you purchase accessories tested and approved by BMW and Original BMW Parts, you simultaneously acquire the assurance that they have been thoroughly tested by BMW to ensure optimum performance when installed on your vehicle.

BMW warrants these parts to be free from defects in material and workmanship.

BMW will not accept any liability for damage resulting from installation of parts and accessories not approved by BMW.

BMW cannot test every product made by other manufacturers to verify if it can be used on a BMW safely and without risk to either the vehicle, its operation, or its occupants.

Original BMW Parts, BMW Accessories and other products approved by BMW, together with professional advice on using these items, are available from all BMW centers.

Installation and operation of non-BMW approved accessories such as alarms, radios, amplifiers, radar detectors, wheels, suspension components, brake dust shields, telephones, including operation of any mobile phone from within the vehicle without using an externally mounted antenna, or transceiver equipment, for instance, CBs, walkie-talkies, ham radio or similar accessories, may cause extensive damage

to the vehicle, compromise its safety, interfere with the vehicle's electrical system or affect the validity of the BMW Limited Warranty. See your BMW center for additional information. ◀

 Maintenance, replacement, or repair of the emission control devices and systems may be performed by any automotive repair establishment or individual using any certified automotive part. ◀

California Proposition 65 warning

California law requires us to issue the following warning:

 Engine exhaust and a wide variety of automobile components and parts, including components found in the interior furnishings in a vehicle, contain or emit chemicals known to the State of California to cause cancer and birth defects and reproductive harm. In addition, certain fluids contained in vehicles and certain products of component wear contain or emit chemicals known to the State of California to cause cancer and birth defects or other reproductive harm.

Battery posts, terminals and related accessories contain lead and lead compounds. Wash your hands after handling.

Used engine oil contains chemicals that have caused cancer in laboratory animals. Always protect your skin by washing thoroughly with soap and water. ◀

Service and warranty

We recommend that you read this publication thoroughly.

Your BMW is covered by the following warranties:

- ▷ New Vehicle Limited Warranty
- ▷ Rust Perforation Limited Warranty
- ▷ Federal Emissions System Defect Warranty
- ▷ Federal Emissions Performance Warranty
- ▷ California Emission Control System Limited Warranty

Detailed information about these warranties is listed in the Service and Warranty Information Booklet for US models or in the Warranty and Service Guide Booklet for Canadian models.

Reporting safety defects

For US customers

The following only applies to vehicles owned and operated in the US.

If you believe that your vehicle has a defect which could cause a crash or could cause injury or death, you should immediately inform the National Highway Traffic Safety Administration, NHTSA, in addition to notifying BMW of North America, LLC, P.O. Box 1227, Westwood, New Jersey 07675-1227, Telephone 1-800-831-1117.

If NHTSA receives similar complaints, it may open an investigation, and if it finds that a safety defect exists in a group of vehicles, it may order a recall and remedy campaign. However, NHTSA cannot become involved in individual problems between you, your dealer, or BMW of North America, LLC.

To contact NHTSA, you may call the Vehicle Safety Hotline toll-free at 1-888-327-4236 (TTY: 1-800-424-9153); go to <http://www.safercar.gov>; or write to: Administrator, NHTSA, 400 Seventh Street, SW., Washington, DC 20590. You can also obtain other information about motor vehicle safety from <http://www.safercar.gov>

For Canadian customers

Canadian customers who wish to report a safety-related defect to Transport Canada, Defect Investigations and Recalls, may call 1-800-333-0510 toll-free from anywhere in Canada or 1-613-993-9851 from the Ottawa region and from other countries, or contact Transport Canada by mail at: Transport Canada, ASFAD, Place de Ville, Tower C, 330 Sparks Street, Ottawa, ON, K1A 0N5.

You can also obtain other information about motor vehicle safety from <http://www.tc.gc.ca>









At a glance



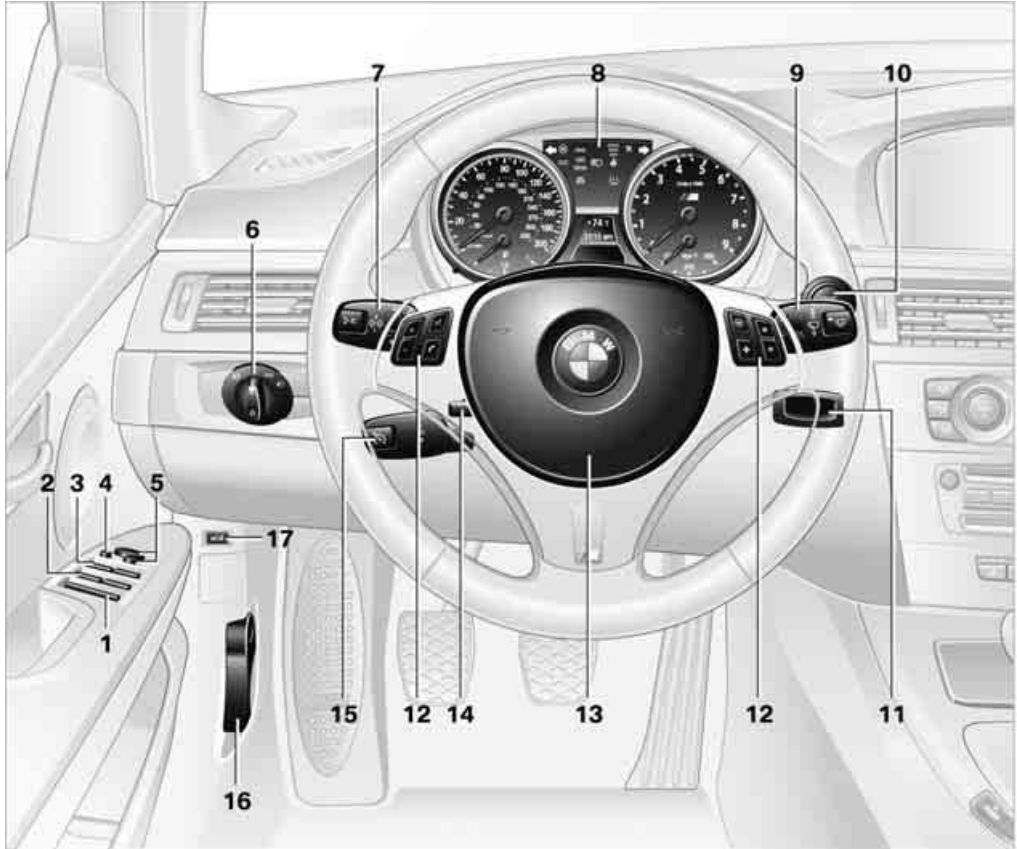

This overview of buttons, switches and displays is intended to familiarize you with your vehicle's operating environment. The section will also assist you in becoming acquainted with the control concepts and options available for operating the various systems.







Cockpit

Around the steering wheel: controls and displays



- 1  Convertible: opening and closing windows jointly 38
- 2  Convertible: opening and closing rear windows 38
- 3  Opening and closing front windows 38
- 4 Folding exterior mirrors in and out* 51
- 5 Adjusting exterior mirrors, automatic curb monitor* 51

- 6  Parking lamps/low beams 99
-  Low beams 99
-  Automatic headlamp control* 99
-  Adaptive Head Light* 100

- 7  Turn signals [68](#)
-  High beams, headlamp flasher [101](#)
-  Roadside parking lamps* [101](#)
- BC** Computer [74](#)
-  Settings and information about the vehicle
-  [77](#)
-  Instrument lighting [101](#)

8 Instrument cluster [12](#)

9  Windshield wipers [69](#)

 Rain sensor* [69](#)

10  Switching the ignition on/off and starting/stopping the engine [59](#)

11 Ignition lock [59](#)

12 Buttons on the steering wheel

-  Telephone*:
 - ▷ Press: accepting and ending a call, starting dialing* selected phone numbers. Redialing if no phone number is selected
 - ▷ Press longer: redialing

 Volume

 Activating/deactivating voice command system* [23](#)

 Changing radio station
Selecting music track

 Scrolling through phone book and lists with stored phone numbers

 MDrive*, calling up individual settings [53](#)

 Individually programmable* [53](#)

 Individually programmable [53](#)

13 Horn: the entire surface

14 Adjusting the steering wheel [52](#)

15  Cruise control [70](#)

16 Releasing the hood [222](#)

17 Opening the luggage compartment lid [33](#)

Instrument cluster



- 1 Speedometer
- 2 Indicator lamps for turn signals
- 3 Indicator and warning lamps [13](#)
- 4 Tachometer [73](#)
- 5 Shift Lights* [66](#)
- 6 Engine oil temperature [74](#)
- 7 Display for
 - ▷ Clock [73](#)
 - ▷ Outside temperature [73](#)
 - ▷ Indicator and warning lamps [83](#)
 - ▷ With dual clutch transmission: Computer [74](#)
- 8 Display for
 - ▷ Gear display M dual clutch transmission with Drivelogic* [62](#)
 - ▷ With manual transmission: Computer [74](#)
 - ▷ Date of next scheduled service, and remaining distance to be driven [78](#)
 - ▷ Odometer and trip odometer [73](#)
 - ▷ Checking oil level [223](#)
 - ▷ Settings and information [77](#)
 - ▷ ▲ There is a Check Control message [83](#)
- 9 Fuel gauge [74](#)
- 10 Resetting the trip odometer [73](#)

Indicator and warning lamps

The concept



Indicator and warning lamps can light up in a variety of combinations and colors. Some lamps are checked for proper functioning and thus come on briefly when the engine is started or the ignition is switched on.

Explanatory text messages



Text messages at the lower edge of the Control Display explain the meaning of the displayed indicator and warning lamps.

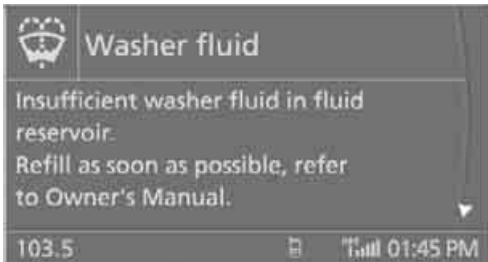









You can call up more information, e.g. on the cause of a malfunction and on how to respond, via Check Control, refer to page 83.

In urgent cases, this information will be shown as soon as the corresponding lamp comes on.

Indicator lamps without text messages

The following indicator lamps notify you that certain functions are active:

-  Parking lamps/low beams 99
-  High beams/headlamp flasher 101
-  Parking brake applied 61
-  MDrive* 54
-  M Dynamic Mode* 88
-  Lamp flashes:
DSC is regulating the drive forces in order to maintain driving stability 88
-  Engine malfunction with adverse effect on exhaust emissions 228
-  Canada: engine malfunction with adverse effect on exhaust emissions 228

Around the center console: controls and displays

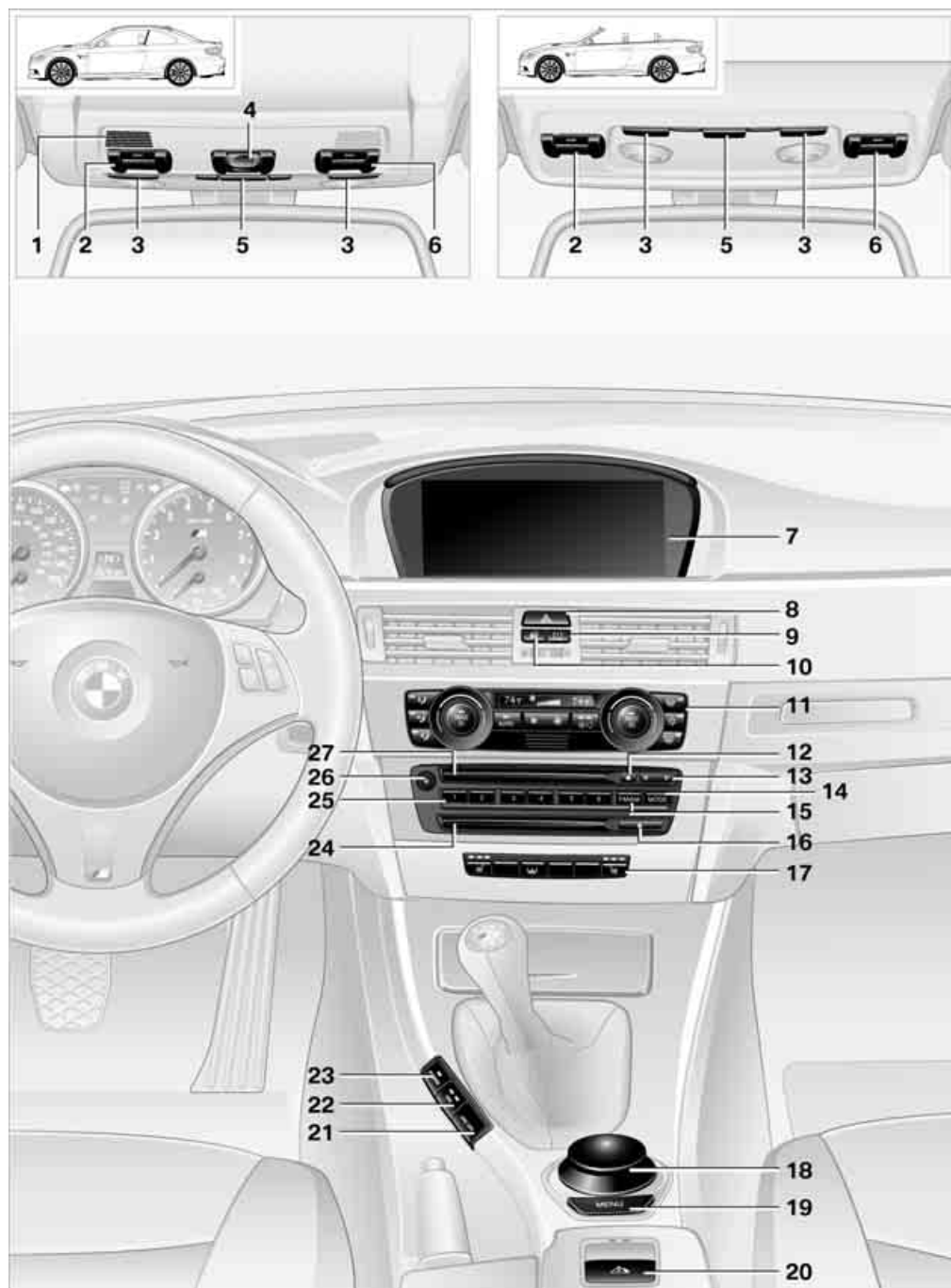

- 1 Microphone for voice command system* and for telephone in hands-free mode* 241
- 2 SOS: initiating an Emergency Request call* 241
- 3 Reading lamps 102
- 4 Coupe: glass roof, electric* 39
- 5 Interior lamps 102
- 6 Passenger airbag status lamp* 96
- 7 Control Display 16
- 8 Hazard warning flashers
- 9 Flat Tire Monitor FTM* 90
Tire Pressure Monitor TPM* 92
- 10 Central locking system 32
- 11 Automatic climate control



Air distribution to the windshield 104



Air distribution to the upper body area 104



Air distribution to the footwell 104



Automatic air distribution and flow rate 105



Cooling function 106



Automatic recirculated-air control AUC 105



Recirculated-air mode 105



Maximum cooling 105



Residual heat mode 106



Air flow rate 105



Defrosting windows 106



Rear window defroster 106

- 12 Ejecting audio CD 162

- 13 Changing

- ▷ Radio station 166

- ▷ Track 176

- 14 Selecting radio, CD and CD changer

- 15 Selecting AM or FM waveband

- 16 Ejecting navigation DVD 134

- 17  Heated seats* 48

-  Coupe:
Roller sun blind* 112

- 18 Controller 16

- Can be turned, pressed, or moved horizontally in four directions

- 19 Opening start menu on Control Display 17

- 20  Convertible:
Opening and closing retractable hardtop 42

- 21 Dynamic Stability Control DSC 88

- 22 Electronic Damper Control EDC* 90

- 23 M Engine Dynamics Control POWER 68

- 24 Drive for navigation DVD 134

- 25 Programmable memory keys 21

- 26 Switching audio sources on/off and adjusting volume 162

- 27 Drive for audio CD 162

iDrive integrates the functions of a large number of switches. This allows these functions to be operated from a single central position. The following section provides an introduction to

basic menu navigation. The control of the individual functions is described in connection with the relevant equipment.

Controls

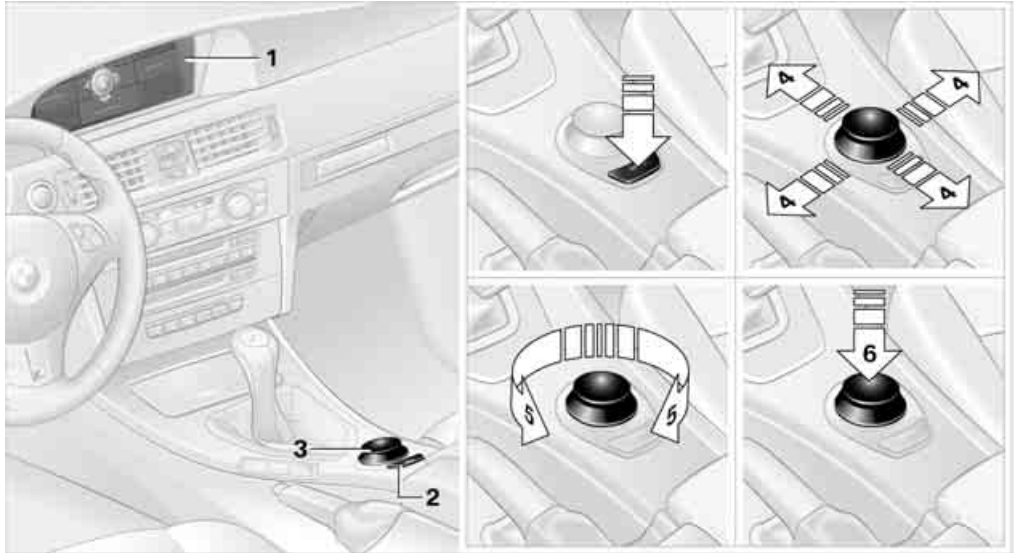

- 1 Control Display
- 2 **MENU** button
Opening start menu
- 3 Controller
The controller can be used to select menu items and to adjust settings:
 - ▷ Move in four directions, arrow 4
 - ▷ Turn, arrow 5
 - ▷ Push, arrow 6

 Operate the controller only when traffic and road conditions allow this, to avoid endangering the car's occupants and other road users by being distracted. ◀

Menu overview

Communication

- ▷ Telephone*
- ▷ BMW Assist* or BMW TeleServices*

Navigation

- ▷ Navigation system*
- ▷ Onboard information, e.g. for displaying the average fuel consumption

Entertainment

- ▷ Radio
- ▷ CD player and CD changer*
- ▷ AUX-In port, USB-audio interface* for external audio device

Climate

- ▷ Vent settings
- ▷ Automatic programs
- ▷ Parked car operation

i menu

- ▷ Switching off Control Display
- ▷ Tone and display settings
- ▷ M settings
- ▷ Settings for your vehicle, e.g. for the central locking system
- ▷ Display of service requirements and dates for statutory inspections
- ▷ Settings for telephone

Operating principle

As of radio readiness, the following message appears on the Control Display:

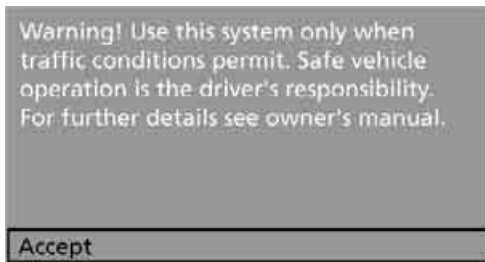

To hide the message:

Press the controller.

The start menu is displayed.

The message is automatically hidden after approx. 10 seconds.

Start menu



All iDrive functions can be called up via five menu items.

Opening start menu

Press the **MENU** button.

To open the start menu from the **i** menu:

Press the **MENU** button twice.

Calling up menu items in the start menu

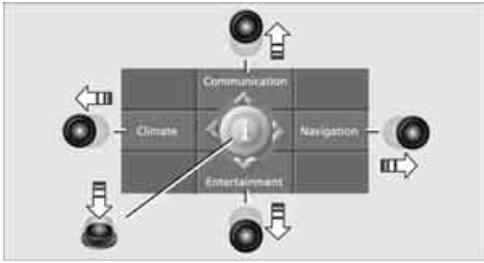

As of radio readiness, refer to page 59:

Via the start menu you can call up the four menu items of Communication, Navigation, Entertainment and Climate by moving the controller forwards, backwards, to the left or to the right.

You can call up the **i** menu by pressing the controller.

Convenient call-up of menu items

The convenient call-up function enables you to:

- ▷ Call up a menu item from the start menu in the view last displayed
- ▷ Switch directly between Communication, Navigation, Entertainment and Climate without having to press the **MENU** button

To do so, move the controller in the corresponding direction and hold it for more than approx. 2 seconds.

Displays in menu

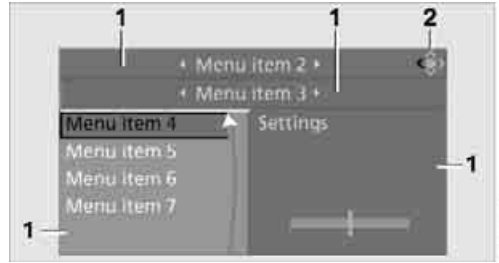

- 1 Each menu is subdivided into fields. The active field is highlighted.
- 2 A symbol indicates the start menu item last selected.

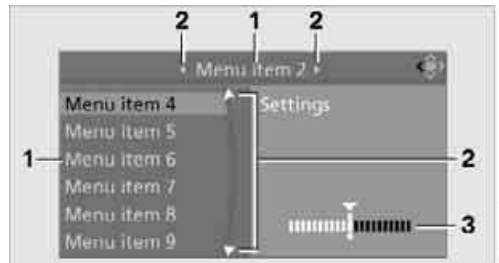
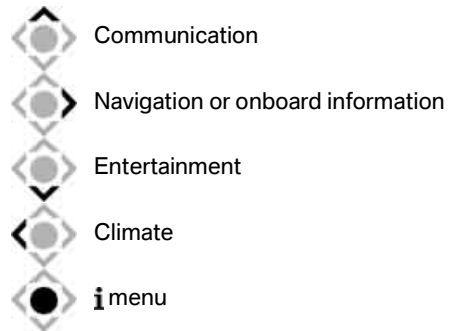

- 1 Menu items are usually grouped in horizontal or vertical lists.
- 2 In these lists, arrows indicate the possibility of accessing other menu items that are not currently visible.
- 3 Settings are represented graphically or as numerical values.

Operating principle at a glance

The following is a general description of operations using iDrive.

For an exemplary step-by-step application refer to Setting the time, page 80.

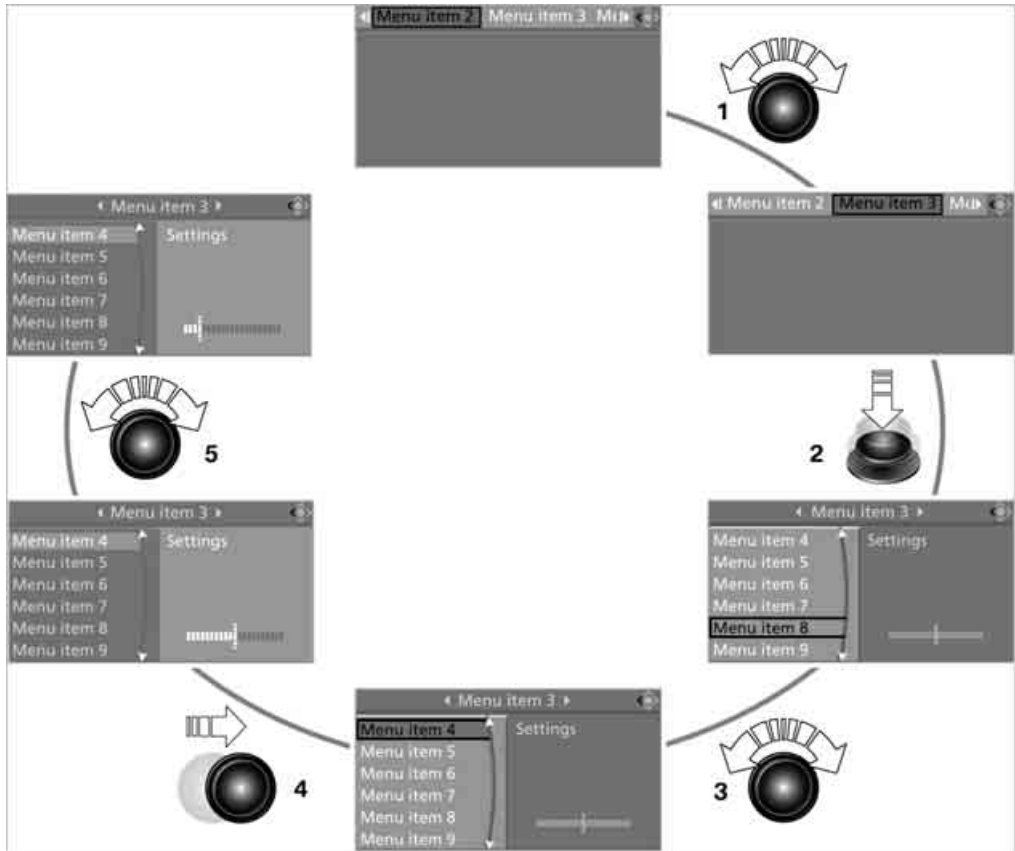

- 1 Selecting a menu item:**
 - ▶ Turn the controller; the highlight marker moves
 - ▶ Menu items in white can be selected by highlighting them
- 2 Activating a menu item:**
 - ▶ Press the controller
 - ▶ New menu items are displayed or the function is executed
- 3 Selecting a menu item: refer to 1**
- 4 Switching between fields:**
 - ▶ Briefly move the controller to the left, right, forward, or backward
 - ▶ Release the controller
 - ▶ The active field is brighter in color
- 5 Adjusting settings:**
 - ▶ Turn the controller
 - ▶ Graphic display, numerical value or text displays can be changed
 - ▶ Confirm by changing the field

Status information



- 1 Display for:
 - ▷ Entertainment: Radio, CD or
 - ▷ Telephone* in "Communication": Name of the connected mobile phone, network search or no network
 - ▷ "BMW Assist"*: Active voice connection with a BMW Assist service
- 2 Entertainment audio output off
- 3 Display for traffic information*: "TI":
Traffic information for the navigation system can be received and transmission is switched on
- 4 Display for:
 - ▷ New entries present in "Missed calls"*
 - ▷ Roaming active
- 5 It is possible to make calls* if the mobile phone is paired with the vehicle
 Reception strength of mobile phone network, display depending on mobile phone
- 6 Time

Other displays:

Status information is temporarily hidden during Check Control message displays or entries via the voice command system*.

Assistance window*



Additional information can be displayed in the assistance window:

- ▷ The computer or the trip computer*
- ▷ The arrow or map view in vehicles with navigation system*
- ▷ The current position*

Selecting display

1. Move the controller to the right to change to the assistance window and press the controller.

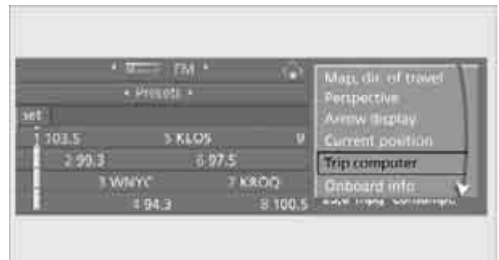

2. Select a menu item.
3. Press the controller.

Switching assistance window on/off

1. Move the controller to the right to change to the assistance window and press the controller.
2. Select "Assist. window off" and press the controller.



To turn back on, switch to the assistance window and press the controller.

Switching Control Display off/on

1. Press the **MENU** button.
This opens the start menu.
2. Press the controller to open the **i** menu.
3. Select "Display off" and press the controller.



Press the controller to switch on.

Programmable memory keys

Using the programmable memory keys, you can store and execute certain iDrive functions:

- ▷ Navigation* destinations

- ▷ Entertainment:
 - ▷ Radio stations
 - ▷ CD
 - ▷ CD compartment of CD changer
 - ▷ AUX
- ▷ Telephone: phone numbers

The assignment of the programmable memory keys is stored for the remote control currently in use.

Storing functions

Navigation* destinations

1. Select the navigation destination, e.g. in the destination list or address book.
2. ... Press the key longer than 2 seconds.

Special features:

- ▷ If destination guidance and the map view have been started, the current destination is stored.
- ▷ If the destination is entered via map, the coordinates in the cross-hairs are stored, not the current destination.

Telephone, phone numbers

1. Enter the phone number or select the number from a list of stored phone numbers, e.g. the A-Z list.
2. ... Press the key longer than 2 seconds.

If the phone number is associated with a name, the name is also stored.

Entertainment

The item stored in the Entertainment menu is the source that is playing at the time of storage, e.g. a radio station, irrespective of what was selected on the Control Display.

1. Select the desired function, e.g. radio station or CD.
2. ... Press the key longer than 2 seconds.

 If the car is equipped with two drives and a CD with compressed audio files is played, the current track is stored. ◀

Executing a function

 ...  Press the key.

The function is executed immediately. This means that, for example, if a phone number is selected, the connection is established, or if a navigation destination is called up, destination guidance is started.

Displaying memory key assignments





You can have the assignment of a memory key displayed by touching the key with your finger. Please do not wear gloves when doing so. Touching the keys with an object such as a pen will not work.

Displaying brief information



 ...  Touch the key.

The key assignment is displayed.



-  Navigation destination
-  Entertainment source
-  Telephone, phone number
-  Not assigned

Displaying detailed information

 ...  Touch the key for a longer period.

Clearing key assignments

1. Press the **MENU** button.
This opens the start menu.
2. Press the controller to open the **i** menu.

3. Select "Settings" and press the controller.
4. Select "Vehicle / Tires" and press the controller.
5. Select "Programmable Memory Keys" and press the controller.



6. Select "Delete assignment of all memory keys" and press the controller.
7. Select "Yes" and press the controller.

Voice command system*

The concept

The voice command system allows you to control operation of various vehicle systems without removing your hands from the steering wheel.

Individual menu items on the Control Display can be spoken as commands. It is not necessary to use the controller.

The voice command system transforms your oral commands into control signals for the selected systems and provides support in the form of instructions or questions.

The voice command system uses a special microphone located in the area of the interior rearview mirror, refer to page 14.

Precondition

Via iDrive, select the language in which the voice command system is operating, so that the spoken commands can be identified. Selecting the language for iDrive, refer to page 85.

Symbols in the Owner's Manual

-  ›...‹ Say the specified commands word for word.
- ››...‹‹ Indicates responses of the voice command system.

Saying commands

Activating voice command system

1. Press the  button on the steering wheel.



 This symbol on the Control Display and an acoustic signal indicate that the voice command system is ready to receive spoken commands.





2. Say the command.
The command appears on the Control Display.



 This symbol appears on the Control Display when you can enter additional commands. If no further commands are possible, continue by operating the item of equipment via iDrive.

Terminating or canceling voice command system

Press the  button on the steering wheel or

 ›Cancel‹

Commands

Having the possible commands read aloud

You can have the system read aloud the possible commands related to the selected menu

item on the Control Display.

To have the possible commands read out to you:

 ›Options‹

For instance, if you have selected "CD", the commands available for operating the CD player and CD changer are read out*.

Opening help

 ›Help‹

Using alternative commands

There are often a number of commands to run a function, e.g.:

 ›Radio on‹ or ›Turn radio on‹

Calling up functions immediately via short commands

Short commands enable you to perform certain functions immediately, irrespective of which menu item is selected, refer to page 252.

Opening the start menu

 ›Main menu‹

Example: selecting a track

1. If necessary, switch on entertainment audio output.
2. Press the  button on the steering wheel.

 3. ›Entertainment‹
The system says:
››Entertainment‹‹



 4. ›CD‹
The system says:
››CD on‹‹



5. Press the  button on the steering wheel.

6. Select a track, e.g.:
- ›Track 1‹
 - The system says:
 - ››Track 1‹‹



Notes

 For information on voice control of the telephone, refer also to the separate Owner's Manual. ◀

For voice commands, bear in mind the following:

- ▶ Pronounce the commands and digits smoothly and at normal volume, avoiding excessive emphases and pauses. The same applies to spelling when entering a destination for navigation.
- ▶ Always speak the commands in the language of the voice command system.
- ▶ When selecting a radio station, use the standard pronunciation of the station name.
- ▶ For entries in the voice-activated phone book, only use names in the language of the voice command system and no abbreviations.
- ▶ Keep the doors, windows and glass roof closed to prevent interference from outside noise.
- ▶ Avoid ambient noise in the vehicle while speaking.





Controls

This chapter is intended to provide you with information for complete control of your vehicle. All features and accessories that are useful for driving and your safety, comfort and convenience, are described here.

Opening and closing

Remote control



Each remote control contains a rechargeable battery that is automatically recharged when it is in the ignition lock while the car is being driven. Use each remote control at least twice a year for longer road trips in order to maintain the batteries' charge status. In cars with convenient access*, the remote control contains a replaceable battery, refer to page 38.

The settings called up and implemented when the car is unlocked depend on which remote control is used to unlock the car, refer to Personal Profile below.

In addition, information about service requirements is stored in the remote control, refer to Service data in the remote control, page 227.

Integrated key



Press button 1 to release the key.

The integrated key fits the following locks:

- ▷ Glove compartment, refer to page 112
- ▷ Driver's door, refer to page 32
- ▷ Luggage compartment lid, refer to page 33

New remote controls

Your BMW center can supply new remote controls with integrated keys as additional units or as replacements in the event of loss.

Personal Profile

The concept

You can set many of your BMW's functions to suit your personal needs and preferences. Without any action on your part, Personal Profile ensures that most of these settings are stored for the remote control currently in use. When you unlock the car, the remote control used for the purpose is recognized and the settings stored for it are called up and implemented.

This means that your personal settings will be activated for you, even if in the meantime your car was used by someone else with another remote control and the corresponding settings. The individual settings are stored for a maximum of four remote controls. They are stored for two remote controls if convenient access* is in use.

Personal Profile settings

For more information on specific settings, refer to the specified pages.

- ▷ Assignment of programmable memory keys, refer to page 21
- ▷ Response of the central locking system when the car is unlocked, refer to page 30
- ▷ Automatic locking of the vehicle, refer to page 32
- ▷ Automatic call-up of the driver's seat position after unlocking, refer to page 49
- ▷ Programming buttons on the steering wheel, refer to page 53
- ▷ MDrive*, refer to page 54

- ▷ Calling up the preferred program of the M Engine Dynamics Control POWER and Electronic Damper Control EDC* when starting the vehicle, refer to Key-dependent settings on page 55
- ▷ Triple turn signal activation, refer to page 68
- ▷ Settings for the displays on the Control Display and in the instrument cluster:
 - ▷ 12h/24h format of the clock, refer to page 82
 - ▷ Date format, refer to page 82
 - ▷ Brightness of the Control Display, refer to page 86
 - ▷ Language on the Control Display, refer to page 85
 - ▷ Units of measure for fuel consumption, distance covered/remaining distances, and temperature, refer to page 77
- ▷ Show visual warning for Park Distance Control PDC*, refer to page 87
- ▷ Light settings:
 - ▷ Welcome lamps, refer to page 99
 - ▷ Pathway lighting, refer to page 100
 - ▷ Daytime running lamps, refer to page 100
- ▷ Automatic climate control: activating/deactivating AUTO program, cooling function and automatic recirculated-air control, setting temperature, air flow rate and distribution, refer to page 104 ff
- ▷ Entertainment:
 - ▷ Audio volume, refer to page 163
 - ▷ Tone control, refer to page 163
 - ▷ Speed-dependent volume control, refer to page 163

Central locking system

The concept

The central locking system functions when the driver's door is closed.

The system simultaneously engages and releases the locks on the following:

- ▷ Doors
- ▷ Luggage compartment lid
- ▷ Fuel filler door
- ▷ Convertible: center armrest and glove compartment

Operating from outside

- ▷ Via the remote control
- ▷ Via the door lock
- ▷ In cars with convenient access*, via the handles on the driver's and front passenger's doors

The anti-theft system is also operated at the same time. It prevents the doors from being unlocked using the lock buttons or door handles. In addition, if the remote control is used, the welcome lamps, interior lamps and the door's courtesy lamps* are switched on or off. The alarm system* is also armed or disarmed. For further details of the alarm system, refer to page 35.

Operating from inside

By means of the button for central locking, refer to page 32.

In the event of a sufficiently severe accident, the central locking system unlocks automatically. In addition, the hazard warning flashers and interior lamps come on.

Opening and closing: Using the remote control



Persons or animals in a parked vehicle could lock the doors from the inside. You should therefore take the remote control with you when you leave the vehicle so that the latter can be opened from outside. ◀



Convertible: to operate the retractable hardtop with the remote control, the doors and luggage compartment lid must be closed and the cargo bay partition must be

folded down and engaged on both sides. Refer also to page 41. ◀

Unlocking

Press the  button.

The interior lamps, the courtesy lamps* and the welcome lamps come on.



Setting unlocking characteristics

You can set whether only the driver's door or the entire vehicle is to be unlocked when the button is pressed for the first time.

iDrive, for operating principle refer to page 16.

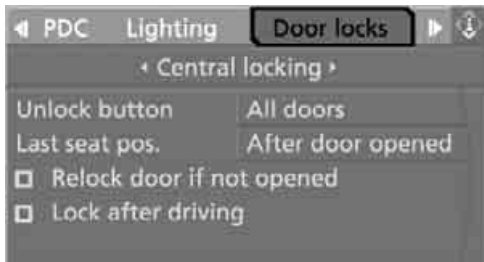
1. Press the **MENU** button.
This opens the start menu.
2. Press the controller to open the **i** menu.
3. Select "Settings" and press the controller.
4. Select "Vehicle / Tires" and press the controller.
5. If necessary, move the highlight marker to the uppermost field. Turn the controller until "Door locks" is selected and press the controller.



6. Select "Central locking" and press the controller.
7. Select "Unlock button" and press the controller.
8. Select a menu item:
 - ▷ "All doors"
Press the  button once to unlock the entire vehicle.
 - ▷ "Driver's door only"
Press the  button once to unlock only the driver's door and the fuel filler door.

Press the button twice to unlock the entire vehicle.



9. Press the controller.
The setting is stored for the remote control currently in use.

Coupe: convenient opening

Hold the  button down.

The windows and the glass roof* are opened.

Convertible: convenient opening*

Within a range of approx. 13 ft/4 m from the vehicle, you can open the retractable hardtop using the remote control for convenient access.

Hold the  button down.

The windows and the retractable hardtop are opened if the doors are closed.

If you continue pressing the  button, the windows move up.

 Watch during the opening process to ensure that no one is injured. Releasing the button interrupts the opening process. ◀

Locking

Press the  button.

 Do not lock the vehicle from the outside if persons are inside the vehicle because it cannot be unlocked from the inside without special knowledge. ◀

Convertible: convenient closing*

Within a range of approx. 13 ft/4 m from the vehicle, you can close the retractable hardtop and the windows using the remote control for convenient access.

Hold the  LOCK button down.
The retractable hardtop and the windows are closed.

 Watch during the closing process to ensure that no one is injured. Releasing the button interrupts the closing process. ◀

Switching on interior lamps

While the car is locked:

Press the  LOCK button.

You can also use this function to locate your vehicle in parking garages etc.

Unlocking the luggage compartment lid

Press the  button for approx. 1 second.

The luggage compartment lid opens a short distance, regardless of whether it was locked or unlocked.

 The luggage compartment lid swings backwards and up when opened. Ensure that there is sufficient clearance. To avoid locking yourself out by accident, do not place the remote control in the cargo bay. A previously locked luggage compartment lid is locked again after closing.

Before and after each trip, check that the luggage compartment lid has not been inadvertently unlocked. ◀

Convertible: convenient loading*

Within a range of approx. 13ft/4m from the vehicle you can use the remote control to half close the retractable hardtop when it is open to ease loading of the cargo bay.

1. Briefly press the  button and, within one second, press again and hold until the retractable hardtop stops in an intermediate position. The luggage compartment lid opens slightly.
2. Open the luggage compartment lid, press the cargo bay partition upward and stow the cargo in the cargo bay.
3. Press down the cargo bay partition until it engages on both sides and close the luggage compartment lid.

4. Press the  button for a longer period to fold the retractable hardtop back in.

Setting confirmation signals

You can activate or deactivate the confirmation signals.

iDrive, for operating principle refer to page 16.

1. Press the **MENU** button.
This opens the start menu.
2. Press the controller to open the **i** menu.
3. Select "Settings" and press the controller.
4. Select "Vehicle / Tires" and press the controller.
5. If necessary, move the highlight marker to the uppermost field. Turn the controller until "Door locks" is selected and press the controller.
6. Select "Confirmation" and press the controller.



7. Select the desired signal*.
8. Press the controller.
 The signal is activated.

Malfunctions

The remote control may malfunction due to local radio waves. If this occurs, unlock and lock the car at the door lock with the integrated key.

If the car can no longer be locked with a remote control, the battery in the remote control is discharged. Use the remote control on an extended trip to recharge the battery, refer to page 28. The remote control for convenient access* contains a battery that may have to be changed, refer to page 38.

For US owners only

The transmitter and receiver units comply with part 15 of the FCC/Federal Communications Commission regulations. Operation is governed by the following:

FCC ID:
LX8766S
LX8766E
LX8CAS

Compliance statement:

This device complies with part 15 of the FCC Rules. Operation is subject to the following two conditions:

- ▷ This device must not cause harmful interference, and
- ▷ This device must accept any interference received, including interference that may cause undesired operation.

 Any unauthorized modifications or changes to these devices could void the user's authority to operate this equipment. ◀

Opening and closing: Using the door lock

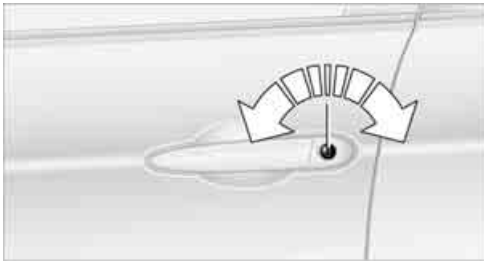

You can set the way in which the car is unlocked, refer to page 30.

 Do not lock the vehicle from the outside if persons are inside the vehicle because it cannot be unlocked from the inside without special knowledge. ◀

Convenient operation

You can use the door lock to operate the windows and the coupe's glass roof* or the convertible's retractable hardtop.

Hold the key in the position for unlocking or locking.

 During each closing procedure, and when opening the retractable hardtop, watch the process and ensure that no one becomes trapped. Releasing the key stops the operation. ◀

Manual operation

In the event of an electrical malfunction, you can lock and unlock the driver's door by turning the integrated key to the corresponding limit positions in the door lock.

Opening and closing: From inside



This button serves to unlock or lock doors and the luggage compartment lid when the doors are closed, but does not activate the anti-theft system. The fuel filler door remains unlocked.

Automatic locking

You can also set the situations in which the car locks:

iDrive, for operating principle refer to page 16.

1. Press the **MENU** button.
This opens the start menu.
2. Press the controller to open the **i** menu.
3. Select "Settings" and press the controller.
4. Select "Vehicle / Tires" and press the controller.
5. If necessary, move the highlight marker to the uppermost field. Turn the controller until "Door locks" is selected and press the controller.

6. Select "Central locking" and press the controller.



7. Select a menu item:
 - ▶ "Relock door if not opened"
The central locking system automatically locks the vehicle after a short time when no door has been opened.
 - ▶ "Lock after driving"
The central locking system automatically locks the vehicle as soon as you drive off.
8. Press the controller.
 The setting is selected.

The setting is stored for the remote control currently in use.

Unlocking and opening doors

- ▶ Either unlock the doors together using the button for the central locking system and then pull the door handle above the armrest or
- ▶ pull on the door handle of each door twice: the first time unlocks the door, the second time opens it.

Locking

- ▶ Use the central locking button to lock all of the doors simultaneously, or
- ▶ press down the safety lock button of a door. To prevent you from being locked out, the open driver's door cannot be locked using the lock button.

 Persons or animals in a parked vehicle could lock the doors from the inside. You should therefore take the remote control with

you when you leave the vehicle so that the latter can be opened from outside. ◀

Luggage compartment lid

 In order to avoid damage, make sure there is sufficient clearance before opening the luggage compartment lid. ◀

Opening from inside



Press the button: the luggage compartment lid opens unless it has been locked.

Opening from outside



Press the button, see arrow, or the  button on the remote control for a longer period. The luggage compartment lid will open slightly. It can now be swung upwards.

Opening manually

The integrated key of the remote control, refer to page 28, fits the luggage compartment lid lock.

 If you open the luggage compartment lid using the key while the alarm system is armed, the alarm will be triggered. Switching off an alarm, refer to page 35. ◀

Coupe

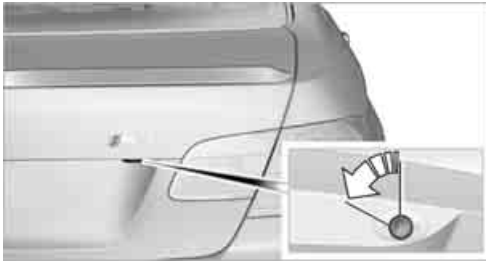

Turn the key all the way to the left: the luggage compartment lid opens.

Convertible

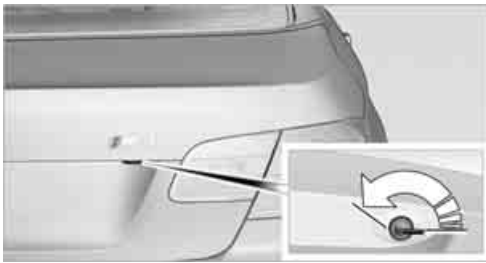

Turn the key all the way to the left beyond the two resistance points: the luggage compartment lid opens.

It may be necessary to close the luggage compartment lid with more momentum since the assisted closing of the luggage compartment lid does not work if there is an electrical malfunction.

Locking or unlocking separately

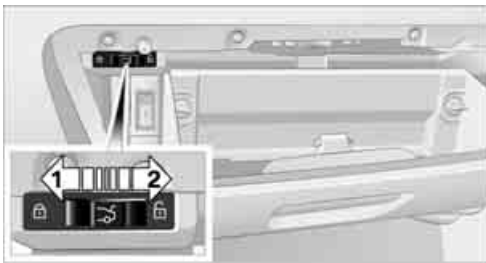

The switch is located in the glove compartment.

- 1 Locking the luggage compartment lid
- 2 Unlocking the luggage compartment lid

Locking separately

Push the switch in the direction of arrow 1. The luggage compartment lid is locked and cannot be unlocked using the central locking system.

If you give the remote control without the integrated key to someone else while the glove compartment is locked, the luggage compartment lid cannot be opened. This is an advantage when valet parking, for example. Locking the glove compartment, refer to page 112.

Unlocking separately

Push the switch in the direction of arrow 2.

Emergency release



Pull the lever in the cargo bay. The luggage compartment lid is unlocked.

Closing

The handle recesses on the interior trim of the luggage compartment lid make it easier to pull down.

 Make sure that the closing path of the luggage compartment lid is clear, otherwise injuries may result. ◀

Coupe



Convertible

 To close the luggage compartment lid, press it down lightly. The lid is closed automatically. ◀



Alarm system*

The concept

The vehicle alarm system responds:

- ▶ When a door, the hood or the luggage compartment lid is opened
- ▶ To movements inside the vehicle: Interior motion sensor, refer to page 36
- ▶ When the car's inclination changes, for instance if an attempt is made to jack it up and steal the wheels or to raise it prior to towing away
- ▶ When there is an interruption in the power supply from the battery

The alarm system signals unauthorized entry attempts for a short time by means of:

- ▶ An acoustic alarm
- ▶ Switching on the hazard warning flashers
- ▶ Flashing the high beams

Arming and disarming

When you lock or unlock the vehicle, either with the remote control or at the door lock, the alarm system is armed or disarmed at the same time.

You can open the luggage compartment lid using the  button of the remote control even if the alarm system is armed, refer to page 31. The lid is locked and monitored again as soon as it is closed.

Panic mode*

You can trigger the alarm system if you find yourself in a dangerous situation:

Press the  button for at least three seconds. To switch off the alarm: press any button.

Switching off an alarm

- ▶ Unlock the car with the remote control, refer to page 30.
- ▶ Insert the remote control all the way into the ignition lock.

Indicator lamp displays



- ▶ The indicator lamp under the inside rearview mirror flashes continuously: the system is armed.
- ▶ The indicator lamp flashes after locking: doors, hood or luggage compartment lid are not properly closed. Even if you do not close the alerted area, the system begins to monitor the remaining areas, and the indicator lamp flashes continuously after approx. 10 seconds. The interior motion sensor and the tilt alarm sensor are not activated.

- ▷ The indicator lamp goes out after unlocking: your vehicle has not been disturbed while you were away.
- ▷ If the indicator lamp flashes after unlocking until the remote control is inserted in the ignition, but for no longer than approx. 5 minutes: your vehicle has been disturbed while you were away.

Tilt alarm sensor

The tilt of the vehicle is monitored. The alarm system reacts, e.g. to attempts to steal a wheel or tow the vehicle.

Interior motion sensor

Coupe

In order for the interior motion sensor to function properly, the windows and glass roof must be completely closed*.

Convertible

The interior of the car is monitored up to the height of the seat cushions. Thus the alarm system is activated together with the interior motion sensor even if the hardtop is open. The alarm can be triggered unintentionally by falling objects such as leaves, refer to Avoiding unintentional alarms.

Avoiding unintentional alarms

The tilt alarm sensor and interior motion sensor may be switched off at the same time. This prevents unintentional alarms, e.g. in the following situations:

- ▷ In duplex garages
- ▷ During transport on car-carrying trains, boats/ships or on a trailer
- ▷ When animals are to remain in the vehicle

Switching off tilt alarm sensor and interior motion sensor

Press the  LOCK button on the remote control again as soon as the vehicle is locked.

The indicator lamp lights up briefly and then flashes continuously. The tilt alarm sensor and

the interior motion sensor are switched off until the next time the vehicle is unlocked and subsequently locked again.

Convenient access*

Convenient access enables you to enter your vehicle without needing to hold the remote control in your hand. All you need to do is wear the remote control close to your body, e.g. in your jacket pocket. The vehicle detects the corresponding remote control within the immediate vicinity or in the passenger compartment.

Convenient access supports the following functions:

- ▷ Unlocking/locking the vehicle
- ▷ Unlocking the luggage compartment lid separately
- ▷ Starting the engine
- ▷ Convenient closure

Functional requirement

- ▷ The vehicle or the luggage compartment lid can only be locked when the vehicle detects that the remote control currently in use is outside of the vehicle.
- ▷ The vehicle cannot be locked or unlocked again until after approx. 2 seconds.
- ▷ The engine can only be started when the vehicle detects that the remote control currently in use is inside the vehicle.

Comparison to the standard remote control

In general, there is no difference between using convenient access or pressing the buttons on the remote control to carry out the functions mentioned above. You should therefore first familiarize yourself with the instructions on opening and closing starting on page 28.

Special features regarding the use of convenient access are described below.

 If you notice a brief delay while opening or closing windows, the glass roof or retractable hardtop, the system is checking whether a

remote control is inside the vehicle. Please repeat the opening or closing procedure, if necessary. ◀

Unlocking

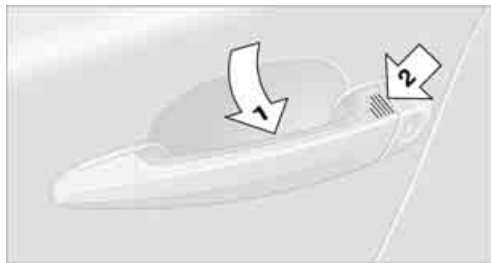

Grasp the handle on the driver's or front passenger's door completely, arrow 1. This corresponds to pressing the  button.

Locking

Touch the surface, arrow 2, with your finger for approx. 1 second. This corresponds to pressing the  LOCK button.

 To preserve the battery, please make sure that the ignition and all electrical consumers are switched off before locking the vehicle. ◀

Coupe: convenient closure

For convenient closure, keep your finger on the surface, arrow 2.

Convertible: window and convertible top operation

With the ignition at radio readiness or beyond, you can open and close the windows and the convertible top when a remote control is located inside the vehicle.

Unlocking the luggage compartment lid separately

Press the button on the outside of the luggage compartment lid. This corresponds to pressing the  button.

 If the vehicle detects that a remote control has been accidentally left inside the locked vehicle's cargo bay after the luggage

compartment lid is closed, the lid will reopen. The hazard warning flashers flash and an acoustic signal* sounds. ◀

Switching on radio readiness

Radio readiness is switched on by pressing the start/stop button, refer to page 59.

 Do not depress the brake or the clutch, otherwise the engine will start. ◀

Starting the engine

You can start the engine or switch on the ignition when a remote control is inside the vehicle. It is not necessary to insert a remote control into the ignition switch, refer to page 59.

Malfunction

Convenient access may malfunction due to local radio waves. If this happens, open or close the vehicle via the buttons on the remote control or using the integrated key. To start the engine afterward, insert the remote control into the ignition switch.

Warning lamps



The warning lamp in the instrument cluster lights up when you attempt to start the engine: the engine cannot be started. The remote control is not inside the vehicle or is malfunctioning. Take the remote control with you inside the vehicle or have it checked. If necessary, insert another remote control into the ignition switch.



The warning lamp in the instrument cluster lights up while the engine is running: the remote control is no longer inside the vehicle. After the engine is switched off, the engine can only be restarted within approx. 10 seconds.



The indicator lamp in the instrument cluster comes on and a message appears on the Control Display: replace the battery in the remote control.

Replacing the battery

The remote control for convenient access contains a battery that will need to be replaced from time to time.

1. Take the integrated key out of the remote control, refer to page 28.



2. Remove the cover.
3. Insert the new battery with the plus side facing up.
4. Press the cover on to close.

 Take the old battery to a battery collection point or to your BMW center. ◀

Windows

 To prevent injuries, watch the windows while closing them.

Take the remote control with you when you leave the car, otherwise children could operate the electric windows and possibly injure themselves. ◀

Coupe: opening, closing



- ▷ Press the switch to the resistance point: The window opens as long as you press the switch.

- ▷ Press the switch beyond the resistance point: The window opens automatically. Press the switch again to stop the opening movement.

You can close the windows in the same manner by pulling the switch.

Convertible: opening, closing

Individually



- ▷ Press the switch to the resistance point: The window opens as long as you press the switch.
- ▷ Press the switch beyond the resistance point: The window opens automatically. Press the switch again to stop the opening movement.

You can close the windows in the same manner by pulling the switch. The rear windows do not close automatically.

Jointly

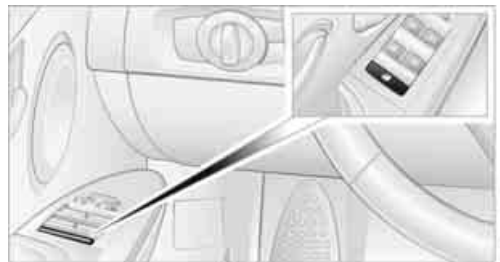

- ▷ Press the switch to the resistance point: All windows open as long as you press the switch.

- ▷ Press the switch beyond the resistance point:
All windows open automatically. Press the switch again to stop the opening movement.
- ▷ Pull the switch:
All windows close as long as you pull the switch.

After switching off the ignition

When the remote control is removed or the ignition is switched off, you can still operate the windows for approx. 1 minute as long as no door is opened.

Convenient operation

For information on convenient operation via the remote control or the door lock, refer to page 29 or 32. For information on closing with convenient access, refer to Locking on page 30.

Pinch protection system

If the closing force exceeds a specific value as a window closes, the closing action is interrupted and the window reopens slightly.

 Despite the pinch protection system check and clear the window's travel path prior to closing it, otherwise the safety system might fail to detect certain kinds of obstructions, such as thin objects, and the window would continue closing. Do not install any accessories that might interfere with window movement. Otherwise the pinch protection system could be impaired. Convertible: the rear windows are not equipped with pinch protection. Therefore, watch them closely when closing to avoid personal injury. ◀

Closing without pinch protection

If there is an external danger, or if ice on the windows, etc., prevents you from closing the windows normally, proceed as follows:

1. Pull the switch past the resistance point and hold it there. Pinch protection is limited and

the window reopens slightly if the closing force exceeds a certain value.

2. Pull the switch again past the resistance point within approx. 4 seconds and hold it there. The window closes without pinch protection.

Coupe: glass roof*, electric

 To prevent injuries, watch the glass roof while closing it.

Take the remote control with you when you leave the car, otherwise children could operate the roof and possibly injure themselves. ◀



Raising

Press the switch.

- ▷ The closed glass roof is raised and the sliding visor opens slightly.
- ▷ The open glass roof automatically travels into the raised position. The sliding visor remains completely open.

Opening, closing

- ▷ Press the switch backwards to the resistance point.
The glass roof and the sliding visor open together as long as you hold the switch in this position.
- ▷ Press the switch backwards past the resistance point.
The glass roof and the sliding visor open automatically. Briefly press the switch again to stop the opening movement.

You can close the glass roof in a similar manner by pressing the switch forwards. The sliding visor remains open and can be closed by hand.

For information on convenient operation via the remote control or door lock, refer to page 29 or 32.

After switching off the ignition

When the remote control is removed or the ignition is switched off, you can still operate the roof for approx. 1 minute as long as no door has been opened.

Pinch protection system

If the glass roof encounters an obstruction during closing from approximately the middle of the opening in the roof, or during closing from the raised position, the closing movement is interrupted and the glass roof is opened again slightly.

 Despite the pinch protection system check and clear the roof's travel path prior to closing it, otherwise the safety system might fail to detect certain kinds of obstructions, such as very thin objects, and the roof would continue closing. ◀

Closing without pinch protection

If there is an external danger, press the switch forward past the resistance point. The roof closes without pinch protection.

Following interruptions in electrical power supply

After a power failure, there is a possibility that the glass roof can only be raised. The system must be initialized. BMW recommends having this work done by your BMW center.

Closing manually*

In the event of an electrical malfunction, you can move the glass roof manually:

1. Unclip the front of the cover of the interior lamps using the screwdriver from the onboard tool kit, refer to page 233.

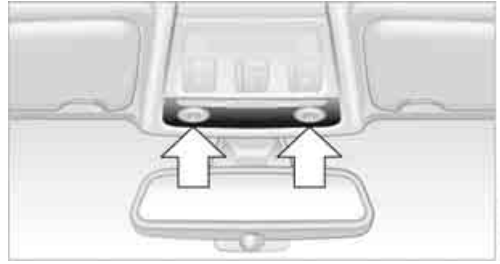

2. Insert the screwdriver into the openings on each side to press the clips.



3. Remove the control unit.
4. Unplug the motor. Considerably less effort will be required for manual operation.

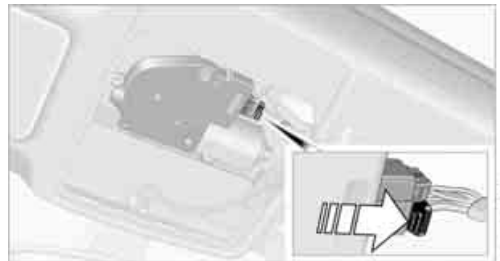

5. Insert the Allen wrench* supplied with the onboard tool kit, refer to page 233, into the

opening provided. Move the glass roof in the desired direction.



6. Reinstall the control unit and reattach the lamp cover.

Convertible: retractable hardtop

The retractable hardtop combines reliable weather protection with simple and convenient operation.

The following tips will enhance your driving pleasure in your convertible:

- ▷ It is advisable that you close the retractable hardtop when you park the vehicle. Not only does the closed hardtop protect the vehicle interior against unanticipated weather damage, it also offers theft protection. However, even when the hardtop is closed, valuables should only be stored in the locked cargo bay.
- ▷ Do not attach roof rack systems to the retractable hardtop, and in particular do not attach magnetic racks.
- ▷ Do not attach rack systems to the luggage compartment lid, and in particular do not attach magnetic racks.
- ▷ When the retractable hardtop is operated, the luggage compartment lid swings back and up. Before operating the retractable hardtop, ensure that there is enough clearance, e.g. when parked in front of a wall.
- ▷ If you open the hardtop while it is wet, e.g. after driving in the rain, water may drip into the cargo bay. If necessary, remove items

from the cargo bay beforehand to avoid water stains or soiling.

 Do not place any objects on the retractable hardtop or on the luggage compartment lid, otherwise they could fall during movements of the retractable hardtop and cause damage or injury.

Never move the retractable hardtop when the rollover protection system is in the activated position.

Driving when the hardtop is not fully opened or closed may result in damage or injury.

Do not reach into the mechanism while the hardtop is opening or closing. Keep children away from the swiveling area of the retractable hardtop. ◀

 The retractable hardtop cannot be moved at temperatures below +14 °F / -10 °C. A message appears on the Control Display. ◀

 The retractable hardtop can only be opened and closed when the vehicle is stationary. To avoid causing damage, do not drive off until the hardtop has stopped moving. ◀

Before opening and closing

- ▷ Comply with the safety precautions described above.
- ▷ Ensure that the cargo bay partition is folded down and engaged on both sides, refer to page 116, otherwise it will not be possible to open the retractable hardtop.
- ▷ Do not place any objects next to or on the cargo bay partition and close the storage compartment on the left side of the cargo bay.
- ▷ Do not exceed the maximum loading height under the cargo bay partition; refer to the label in the cargo bay showing a line indicating the maximum height.
- ▷ Ensure that the luggage compartment lid is closed.
- ▷ The vehicle should be parked on fairly level ground. Excessive angle is indicated by a lamp.

Opening and closing

When the vehicle is stationary and at radio readiness or beyond, refer to page 59:

- ▷ If possible, conserve the battery by only operating the retractable hardtop when the engine is running.

Before closing the retractable hardtop, remove all foreign objects from the windshield frame as these could prevent the hardtop from closing properly. ◀



- 1 Pull button: open the retractable hardtop. Push button: close the retractable hardtop.
- 2 LEDs

- ▷ The side windows move down slightly when the switch for hardtop operation is pulled or pushed. ◀

If you push or pull the switch for a longer period after the LED 2 goes out, the windows move up again.

LEDs

In the following situations, a message appears on the Control Display or an acoustic signal sounds in addition to the LED lighting up:

- ▷ While the hardtop is being operated, the left LED lights up green. It goes out as soon as the top is fully opened or closed.
- ▷ If the right-hand LED flashes red when you release the switch, the opening or closing action has not yet finished.
- ▷ If the right LED lights up red when the switch is pressed, the cargo bay partition is folded up, the luggage compartment lid is not closed, the vehicle is standing on a strong incline or there is a malfunction. The retractable hardtop cannot be moved.

Interruption

The automatic sequence of movements is interrupted if the switch for hardtop operation is released. The sequence can be continued in the desired direction by pushing or pulling the switch.

- ⚠ A hardtop that is not fully opened or closed is a safety hazard. Do not interrupt and resume the closing procedure several times in close succession as this could damage the mechanism. ◀

- ▷ If the hardtop is not fully opened or closed, the luggage compartment lid cannot be opened and the windows cannot be moved. ◀

Convenient operation with remote control or via door lock

Refer to pages 30 and 32.

Wind deflector*

The wind deflector keeps air movements in the passenger compartment to a minimum when the hardtop is open and provides an even more comfortable ride, particularly at high speeds.

Installation

The wind deflector is stored in a protective cover in the cargo bay. Brief instructions for operation can be found on the protective cover.

1. Remove the wind deflector from the protective cover and unfold it, arrows 1.

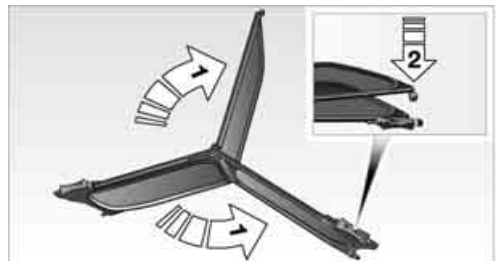

- Press together the top and bottom parts of the wind deflector until the catch engages, arrow 2.

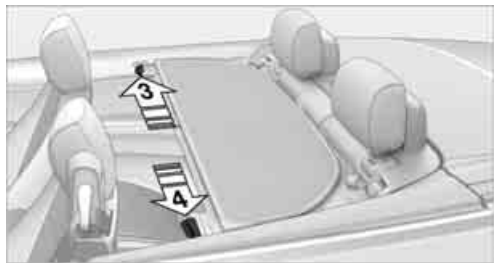

- Push the fastening pin, arrow 3, into the opening provided on the right side of the vehicle until it snaps into place. Remove the protective caps beforehand, if necessary.
- Push the fastening pin, arrow 4, into the opening provided on the left side of the vehicle until it snaps into place.



- Turn the rotary handle in the direction of arrow 5 as far as the first stop to insert the right fastening pin into the holders.
- Turn the rotary handle in the direction of arrow 6 as far as the lock symbol to insert the left fastening pin into the holders.
- Fold up the top section of the wind deflector.

⚠ With the wind deflector installed: do not recline the front-seat backrests too far if the seat is to be slid all the way back, as this would damage the wind deflector. ◀

⚠ Only turn the rotary handle within the range between the two symbols, otherwise the cable system inside the wind deflector could be damaged. ◀

Removing the wind deflector

Proceed in the reverse order as used for installation.

Protective caps are provided in the vehicle for the holders of the wind deflector.

Folding

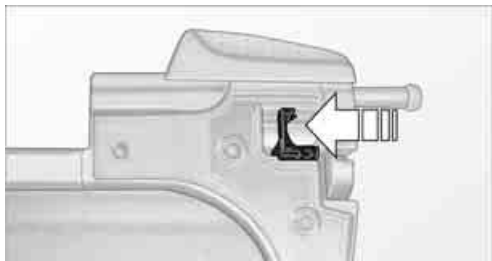



Slide the red release lever towards the middle of the wind deflector and push the two halves apart.

Loading function

Cargo can still be loaded on the rear seat of the vehicle even if the wind deflector has been installed.

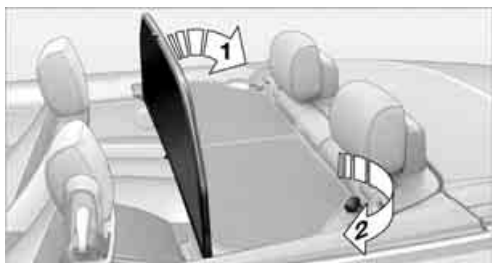
- Lower all windows.
- Fold down the top section of the wind deflector, arrow 1.



3. Turn the rotary handle to position , arrow **2**.



Fold both sections of the wind deflector forward and rest them against the front seats, arrow **3**.

To protect the seat cushions or to use the bag holders, you can fold the rear backrest down, refer to page [117](#).

Adjustments

Sitting safely

The ideal sitting position can make a vital contribution to relaxed, fatigue-free driving. In conjunction with the safety belts, the head restraints and the airbags, the seated position has a major influence on your safety in the event of an accident. To ensure that the safety systems operate with optimal efficiency, we strongly urge you to observe the instructions contained in the following section.

For additional information on transporting children safely, refer to page 57.

Airbags

 Always maintain an adequate distance between yourself and the airbags. Always grip the steering wheel on the rim, with your hands in the 3 o'clock and 9 o'clock positions, to minimize the risk of injury to the hands or arms in the event of the airbag being triggered off.

No one and nothing is to come between the airbags and the seat occupant.

Do not use the cover of the front airbag on the front passenger side as a storage area. Make sure that the front passenger is sitting correctly, e.g. not resting feet or legs on the dashboard, otherwise leg injuries can occur if the front airbag is triggered.

Make sure that passengers do not lean their heads against the side or head airbags, otherwise serious injuries could result if the airbags suddenly deployed. ◀

Even if you follow all the instructions, injuries resulting from contact with airbags cannot be fully excluded, depending on the circumstances. The ignition and inflation noise may provoke a mild hearing loss in extremely sensitive individuals. This effect is usually only temporary.

For airbag locations and additional information on airbags, refer to page 95.

Head restraint

A correctly adjusted head restraint reduces the risk of neck injury in the event of an accident.

 Adjust the head restraint in such a way that its center is at approx. ear level. Otherwise, there is an increased risk of injury in the event of an accident. ◀

Head restraints, refer to page 47.

Safety belt

Before every drive, make sure that all occupants wear their safety belts. Airbags complement the safety belt as an additional safety device, but they do not represent a substitute.

Your vehicle has four seats, each of which is equipped with a safety belt.

 Never allow more than one person to wear a single safety belt. Never allow infants or small children to ride in a passenger's lap. Make sure that the belt in the lap area sits low across the hips and does not press against the abdomen.

The safety belt must not rest against the throat, run across sharp edges, pass over hard or fragile objects or be pinched. Fasten the safety belt so that it sits as snugly as possible against the lap and shoulder without being twisted. Otherwise the belt could slide over your hips and injure your abdomen in the event of a frontal collision.

Avoid wearing bulky clothing and regularly pull the belt in the upper-body area taut, otherwise its restraining effect could be impaired. ◀

Safety belts, refer to page 50.

Seats

Note before adjusting

 Never attempt to adjust your seat while the vehicle is moving. The seat could respond with unexpected movement, and the ensuing loss of vehicle control could lead to an

accident.

On the front passenger seat as well, do not incline the backrest too far to the rear while the vehicle is being driven, otherwise there is a danger in the event of an accident of sliding under the safety belt, eliminating the protection normally provided by the belt. ◀

Comply with the instructions on head restraint height on page 47, and on damaged safety belts on page 50.

Manual adjustment

 Observe the adjustment instructions above to ensure the best possible personal protection. ◀

Thigh support



Pull the lever and move the thigh support forward or back.

Electrical adjustment

 Observe the adjustment instructions on page 45 to ensure the best possible personal protection. ◀

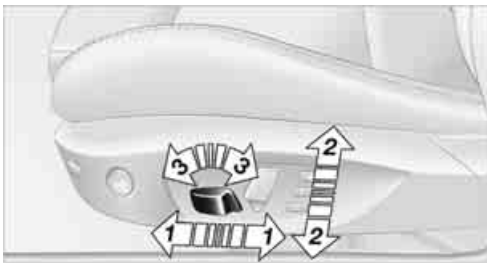

- 1 Longitudinal direction
- 2 Height
- 3 Angle



4 Backrest

The head restraints are adjusted manually, refer to Head restraints below.

Lumbar support*



You can also adjust the contour of the backrest to obtain additional support in the lumbar region.

The upper hips and spinal column receive supplementary support to help you maintain a relaxed, upright sitting position.

- ▷ Increase or decrease curvature: press the switch at the front or rear, respectively.
- ▷ Shift curvature up or down: press the switch at the top or bottom, respectively.

Backrest width*



You can change the width of the backrest to suit your individual preferences by adjusting the lateral-support pads.

Press the front or rear end of the switch. Backrest width decreases or increases accordingly.

Longitudinal adjustment from outside/behind

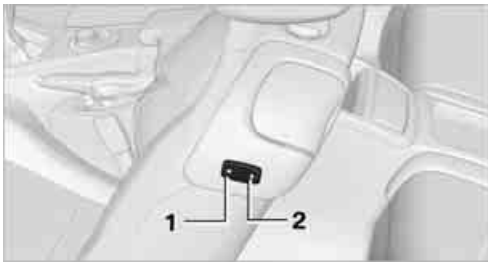

To move the front seats forward or backward from outside or from one of the rear seats: with the door open, press the front end **1** or rear end **2** of the switch.

Head restraints

A correctly adjusted head restraint reduces the risk of neck injury in the event of an accident.

 Adjust the head restraint in such a way that its center is at approx. ear level. Otherwise, there is an increased risk of injury in the event of an accident. Only remove a head restraint if no one will be sitting on the seat in question. Reinstall the head restraint before transporting anyone on that seat. Otherwise, the passenger will be without protection from the head restraint. ◀

Front seats

Coupe: height adjustment

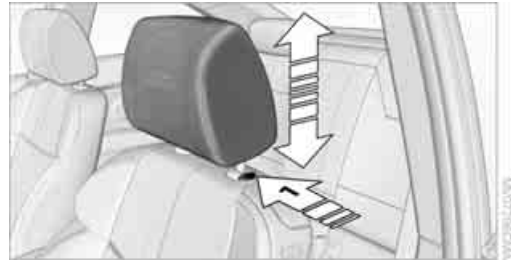

- ▶ To raise: pull up.
- ▶ To lower: press the button, arrow **1**, and slide the head restraint down.

Coupe: removing

1. Pull up as far as it will go.
2. Press the button, arrow **1**, and pull the head restraint all the way out.

Convertible: height adjustment

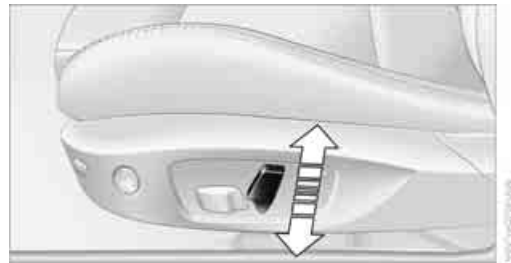

- ▶ To raise: press the button upward.
- ▶ To lower: press the button downward.

Coupe: rear seats

Height adjustment

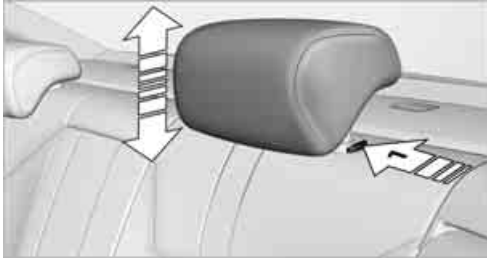

- ▷ To raise: pull up.
- ▷ To lower: press the button, arrow 1, and slide the head restraint down.

Removing

1. Pull up as far as it will go.
2. Press the button, arrow 1, tilt the rear seat backrest slightly forward and pull the head restraint all the way out.

 Only remove the head restraints if no passengers will be sitting in the rear. Reinstall head restraints before transporting passengers in the rear. ◀

Entering the rear seats

Coupe

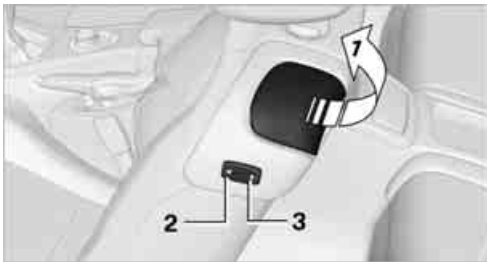

Convertible

 Seat backrest warning lamp: Comes on when a seat backrest is not engaged. In addition, a message appears on the Control Display.

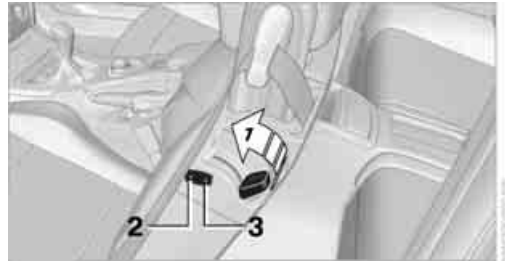

Convenient entry

The convenient entry feature includes a memory function for the longitudinal adjustment and backrest angle.

1. Pull lever 1 and swing the backrest forward.
2. Press the front end 2 of the switch until the seat has moved into the desired position.

Previous position

Press the rear end 3 of the switch until the seat automatically stops in its previous position, and fold the backrest back. If you release the switch before the previous seat position is reached, the seat will stop at its current position.

 When sliding the seat backward, make sure no one is injured and no objects are damaged.

Before driving off, engage both seats and backrests so that they are locked in place. Otherwise there is a risk of accident due to an unexpected movement. ◀

Heated seats*



Press once for each temperature level. Three LEDs indicate the highest temperature.

To switch off:
Press button longer.

If you continue driving within approx. 15 minutes, the seat heating is automatically activated at the previously set temperature.

The temperature is lowered or the heating is switched off entirely to save on battery power. The LEDs stay lit.

Seat and mirror memory

You can store and call up two different combinations of driver's-seat and exterior-mirror positions.

Settings for the backrest width and lumbar support are not stored in memory.

Storing

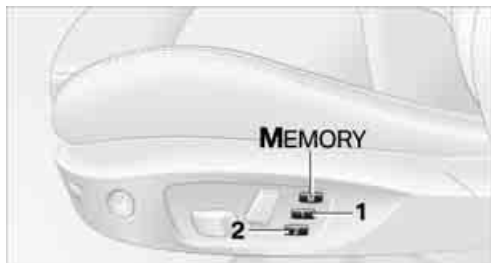

1. Switch on radio readiness or the ignition, refer to page 59.
2. Adjust the seat and exterior mirrors to the desired positions.
3. Press the **M** button.
The LED in the button lights up.
4. Press the desired memory button **1** or **2**: the LED goes out.

The driver's seat and exterior mirror positions are stored for the remote control currently in use.

Call-up

⚠ Do not call up memory while you are driving, otherwise unexpected seat movement could result in an accident. ◀

Convenience mode

1. Unlock and open the driver's door or switch on radio readiness, refer to page 59.
2. Briefly press the desired memory button **1** or **2**.

The adjusting procedure is halted immediately when you touch a seat adjustment switch or one of the memory buttons.

Safety feature

1. Close the driver's door and switch the ignition on or off, refer to page 59.
2. Press the desired memory button **1** or **2** and keep it pressed until the adjustment process has been completed.

If the **M** button was pressed accidentally: Press the button again; the LED goes out.

Call-up with the remote control

The driver's seat position last stored is stored for the remote control currently in use.

You can select the occasion on which the seat is reset to that position.

- ▷ Call-up when the vehicle is unlocked.
- ▷ Call-up when the driver's door is opened.

⚠ When this Personal Profile function is used, first make sure that the footwell behind the driver's seat is free of obstacles. Failure to do so could cause injury to persons or damage to objects as a result of a rearward movement of the seat. ◀

The adjusting procedure is halted immediately when you touch a seat adjustment switch or one of the memory buttons.

Selecting automatic call-up

iDrive, for operating principle refer to page 16.

1. Press the **MENU** button.
This opens the start menu.
2. Press the controller to open the **i** menu.
3. Select "Settings" and press the controller.
4. Select "Vehicle / Tires" and press the controller.

5. If necessary, move the highlight marker to the uppermost field. Turn the controller until "Door locks" is selected and press the controller.

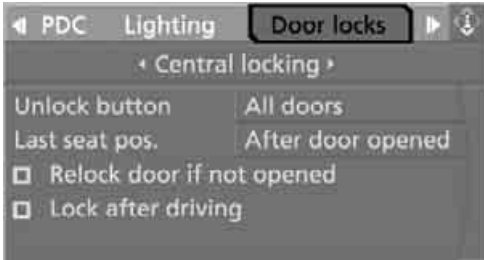

6. Select "Central locking" and press the controller.
7. Select "Last seat pos." and press the controller.
8. Select "After unlocking" or "After door opened".



9. Press the controller.

Switching off automatic call-up

Select "Deactivated" and press the controller.

Safety belts

 Observe the adjustment instructions on page 45 to ensure the best possible personal protection. ◀

Before every drive, make sure that all occupants wear their safety belts. Airbags complement the safety belt as an additional safety device, but they do not represent a substitute.



Closing

Make sure you hear the latch plate engage in the belt buckle.

The upper belt anchor is suitable for adults of any stature as long as the seat is adjusted properly, refer to page 45.

Opening

1. Grasp the belt firmly.
2. Press the red button in the buckle.
3. Guide the belt into its reel.

'Fasten safety belts' reminder for front seats



The indicator lamps come on and an acoustic signal sounds. In addition, a message appears on the Control Display. Check whether the safety belt has been fastened correctly.

The 'Fasten safety belts' reminder is issued as long as the driver's safety belt has not been fastened. The 'Fasten safety belts' reminder is also activated at road speeds above approx. 5 mph or 8 km/h if the front passenger's safety belt is not fastened, if objects are placed on the front passenger seat, or if driver or front passenger unfasten their safety belts.

Damage to safety belts

 If the safety belts are damaged or stressed in an accident: have the belt system, including any belt tensioners or child-restraint systems, replaced and the belt anchors checked. Have this work done only by your BMW center or at a workshop that works according to BMW repair procedures with cor-

respondingly trained personnel. Otherwise, it is not guaranteed that the safety devices will function properly. ◀

Coupe: belt hand-over

The concept

The belt hand-over makes it easier for you to fasten your safety belt. When you close the door and switch on radio readiness or the ignition, the belt hand-over extends automatically and presents the safety belt in a position that is convenient for fastening it around you. After you have fastened your safety belt, the belt hand-over retracts to its original position.



Even if you have not yet fastened your safety belt, the belt hand-over will retract if you:

- ▶ Wait for more than approx. one minute
- ▶ Open the corresponding door
- ▶ Start to drive.

Closing the respective door reactivates the belt hand-over if the ignition or radio-readiness is on.

Front passenger's seat

The belt hand-over will extend only if the seat is occupied and after the front passenger's door is closed.

Pinch protection system

If the belt hand-over encounters resistance on moving in or out, it moves back slightly in the opposite direction and stops in this position. To reactivate the belt hand-over: open and close the door or switch the ignition off and on.

 Although there is a pinch protection system, always check that the maneuvering area of the belt hand-over is clear. Otherwise it cannot be ensured that the system will stop moving in certain extreme situations. ◀

Mirrors

Exterior mirrors

 The front passenger's mirror is more convex than the driver's mirror. The objects seen in the mirror are closer than they appear. Do not gauge your distance from traffic behind you on the basis of what you see in the mirror; otherwise there is an increased risk of an accident. ◀

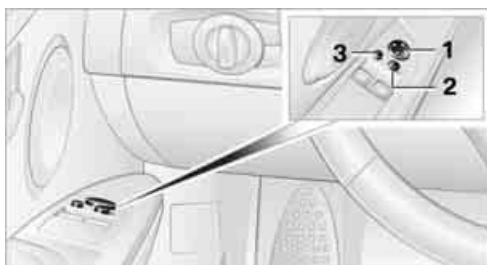

- 1 Adjustments
- 2 Switching to the other mirror or automatic curb monitor*
- 3 Folding mirrors in and out*

The setting for the exterior mirrors is stored for the remote control currently in use. The stored position is called up automatically when the vehicle is unlocked.

Manual adjustment

The mirrors can also be adjusted manually: press the edge of the glass.

Folding mirrors in and out*

At driving speeds up to approx. 12 mph/20 km/h, you can fold the mirrors in and out by pressing button **3**. This can be beneficial in narrow streets, for example, or for moving mirrors that were folded in by hand back out into their correct positions. Mirrors that were folded in are

folded out automatically at a speed of approx. 25 mph/40 km/h.

! Before entering an automatic car wash, fold in the exterior mirrors by hand or with button **3**, to prevent them from being damaged due to the width of the vehicle. ◀

Automatic heating

Depending on the outside temperature, both exterior mirrors are heated automatically when the engine is running or the ignition is switched on.

Passenger-side mirror tilt function – automatic curb monitor*

Activating

1. Push the switch to the position for the driver's-side mirror, arrow **1**.

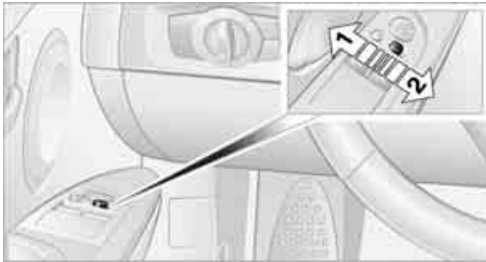

2. Engage reverse gear or transmission position R.

The glass of the mirror on the passenger side tilts slightly down. This allows the driver to see the area immediately adjacent to the vehicle, e.g. a curb, when backing into a parking space.

Deactivating

Push the switch to the position for the passenger-side mirror, arrow **2**.

Interior and exterior mirrors*, automatic dimming feature

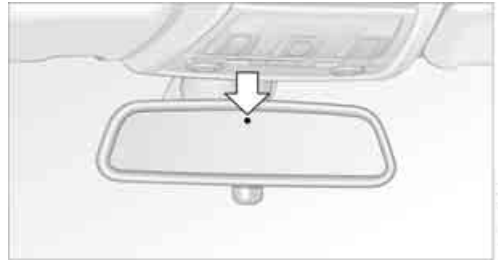

The automatic dimming feature of the interior and exterior mirrors* is controlled by two photo cells in the interior rearview mirror. One photo cell is in the mirror frame, see arrow; the other is on the back of the mirror.

In order to ensure that the system functions correctly, keep the photo cells clean, do not cover the area between the interior rearview mirror and windshield, and do not affix adhesive labels or stickers of any kind to the windshield directly in front of the mirror.

Steering wheel

Adjustments

! Do not adjust the steering wheel position while the car is in motion, otherwise there is a risk of accident due to an unexpected movement. ◀

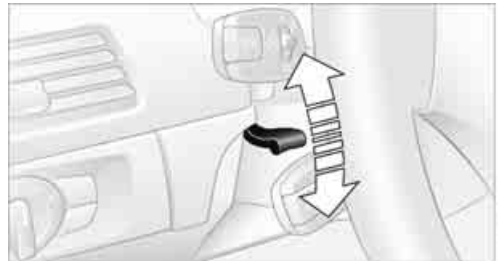

1. Fold the lever down.
2. Move the steering wheel to the preferred height and angle to suit your seated position.
3. Swing the lever back up.



Do not use force to swing the lever back up, otherwise the mechanism will be damaged. ◀

Programmable buttons on the steering wheel

Depending on the equipment, you can individually program either one or two buttons:



This setting is stored for the remote control currently in use.

iDrive, for operating principle refer to page 16.

1. Press the **MENU** button.
This opens the start menu.
2. Press the controller to open the **i** menu.
3. Select "Settings" and press the controller.



4. Select "Steering wheel buttons" and press the controller.

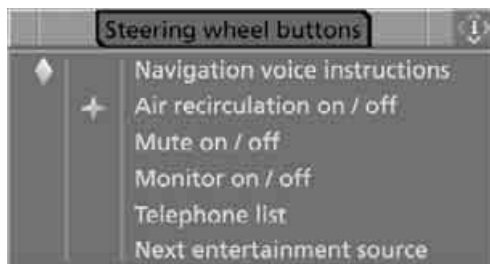

A list showing various functions is displayed:

- ▷ "Navigation voice instructions"
Voice messages from the navigation system*
 - ▷ "Air recirculation on / off"
Permanent shut-off of outside air, refer to Automatic recirculated-air control AUC on page 105
 - ▷ "Mute on / off"
To mute the audio sources
 - ▷ "Monitor on / off"
To switch the Control Display on/off
 - ▷ "Telephone list"*
To show/hide the phone book or last displayed list of stored phone numbers
 - ▷ "Next entertainment source"
To change the audio source
5. Select the desired function and press the controller.
 6. With two programmable buttons: select the button and press the controller.



Operating a function

Briefly press the button on the steering wheel.

If you have programmed "Navigation voice instructions" for one button:

- ▷ Switch voice instructions on/off:
Press the button for a longer period.
- ▷ To repeat the last voice instruction:
Press the button briefly.
- ▷ To cancel a voice instruction during an announcement:
Press the button briefly.

MDrive*

With MDrive you can configure several individual settings for your vehicle on the Control Display and activate them using the  button on the steering wheel.

Configuring settings

You can set MDrive on the Control Display when the ignition is switched on.

iDrive, for operating principle refer to page 16.

1. Press the **MENU** button.
This opens the start menu.



2. Press the controller to open the **i** menu.
3. Select "M settings" and press the controller.
4. Select "MDrive" and press the controller.

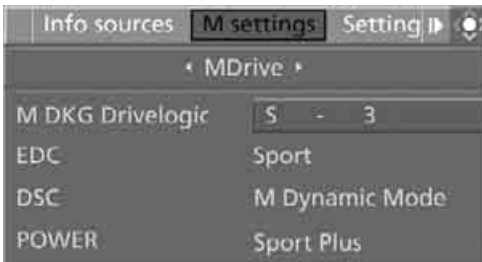

The functions contained in MDrive are displayed:

- ▷ "M DKG Drivelogic"
M dual clutch transmission with Drivel-

ogic: shift modes and Drivelogic drive programs, refer to page 65

- ▷ "EDC"
Programs of the Electronic Damper Control EDC*, refer to page 90
- ▷ "DSC"
Dynamic Stability Control and M Dynamic Mode, refer to page 88
- ▷ "POWER"
Programs of the M Engine Dynamics Control, refer to page 68
- ▷ "Servotronic"
Programs of the Servotronic, refer to page 95
- ▷ "Shift lights"
Shift Lights, refer to page 66

You can reset all MDrive settings to their default values:

- ▷ "Reset to default"

5. Select the desired function.

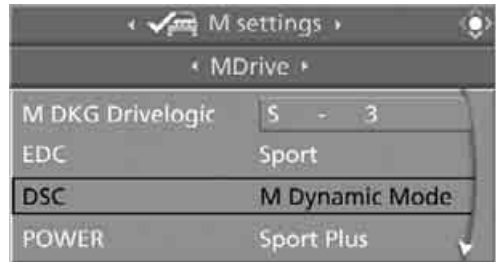

6. Press the controller.
7. Turn the controller to select the desired setting.





"Unchanged" retains the current setting made outside of MDrive.

8. Press the controller.



The setting is stored for the remote control currently in use.

Activating the settings

Press the  button on the steering wheel.

 The indicator lamp in the instrument cluster comes on. The settings made on the Control Display for the functions in MDrive are active.

Pressing the button again deactivates MDrive.

 If the indicator lamp flashes after the button was pressed, MDrive was unable to respond because the Antilock Brake System ABS or Dynamic Stability Control DSC are currently regulating driving stability. Press the  button again when the indicator lamp is no longer flashing. ◀

You can change individual settings outside of MDrive even when MDrive is activated, e.g. using the buttons on the center console. To reactivate all settings made on the Control Display for MDrive: press the  button twice.

Key-dependent settings

For the remote control currently in use, you can set your preferred program for the M Engine Dynamics Control and Electronic Damper Control EDC. These presettings are called up when the engine is started.

iDrive, for operating principle refer to page 16.

1. Press the **MENU** button.
This opens the start menu.



2. Press the controller to open the **i** menu.
3. Select "M settings" and press the controller.

4. Select "Key-dependent settings" and press the controller.



The available functions are displayed:

- ▷ "POWER"
Programs of the M Engine Dynamics Control, refer to page 68
- ▷ "EDC"
Programs of the Electronic Damper Control EDC*, refer to page 90
- ▷ "Shift lights"
Shift Lights, refer to page 66

5. Select the desired function.



6. Press the controller.
7. Turn the controller to select the desired setting.



8. Press the controller.

The setting is stored for the remote control currently in use.

Transporting children safely

The right place for children

 Do not leave children unattended in the vehicle, otherwise they could endanger themselves and/or other persons by opening the doors, for example. ◀

Children always in the rear

Accident research has shown that the safest place for children is on the rear seat.

 Children under the age of 13 or smaller than 5 ft/150 cm may be transported only in the rear in suitable child-restraint systems appropriate for their age, weight and size. Otherwise there is an increased risk of injury in the event of an accident. ◀

Children 13 years of age or older must be buckled in with a safety belt as soon as there no longer is any child-restraint system that is appropriate for their age, size and weight.

Exception for front passenger seat

 Should it be necessary to use a child-restraint system on the front passenger seat, the front and side airbags for the front passenger must be deactivated. Otherwise, a child traveling on that seat will face a significant risk of injury if the airbags are triggered off, even with a child-restraint system. ◀

For more information on automatic deactivation of the front passenger airbags refer to page 96.

Installing child-restraint systems

 Observe the child-restraint system manufacturer's instructions when selecting, installing and using child-restraint systems. Otherwise the protective effect may be diminished. ◀

Standard child-restraint systems are designed to be secured with a lap belt or with the lap-belt section of a lap-and-shoulder belt. Incorrectly

or improperly installed child-restraint systems can increase the risk of injury to children. Always follow the installation instructions for the system with the greatest care.

On the front passenger seat

 After installing a child-restraint system on the front passenger seat, make sure that the front and side airbags for the front passenger are deactivated, otherwise there is an increased risk of injury if the airbags deploy. ◀

Backrest width*

 The backrest width of the front passenger's seat must be at its widest possible setting. Do not change the setting after installing the child seat. Otherwise the child seat's stability on the front passenger's seat is limited. ◀

1. Adjust the backrest width to its widest setting, refer to page 47.
2. Install the child seat.

Child seat security



The rear safety belts and the front passenger's safety belt can be prevented from being pulled out in order to fasten child-restraint systems.

To lock the safety belt

1. Secure the child-restraint system with the belt.
2. Pull the belt strap all the way out.

3. Allow the belt strap to retract and pull it taut against the child-restraint system.

The safety belt is locked.

To unlock the safety belt

1. Open the belt buckle.
2. Remove the child-restraint system.
3. Allow the safety belt strap to retract all the way.

LATCH child-restraint fixing system

LATCH: Lower Anchors and Tethers for Children.

⚠ To install and use the LATCH child restraint system, follow the operating and safety instructions provided by the manufacturer of the system, otherwise the protective function of the seat may be compromised. ◀

Before installing the child seat, pull the belt out of the area for the child-restraint fixing system.

⚠ Ensure that both lower LATCH anchors are correctly engaged and that the child restraint system is resting firmly against the backrest, otherwise the protective function of the seat may be compromised. ◀

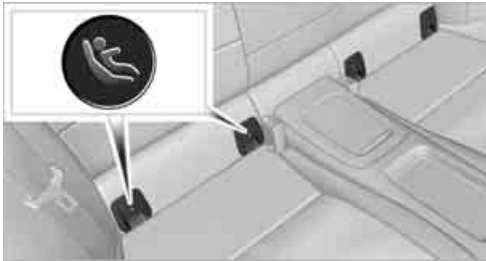

The anchor points for the lower LATCH anchors are located behind the labeled protective caps.

Coupe: child-restraint system with tether strap

⚠ Use the top tether anchors to secure child-restraint systems only, otherwise the anchors could be damaged. ◀



For child-restraint systems with tether straps there are two additional anchors, see arrows.

Coupe: placement of the tether strap

⚠ Make sure the upper retaining strap does not run over sharp edges and is not twisted as it passes to the top anchor. Otherwise the strap will not properly secure the child-restraint system in the event of an accident. ◀

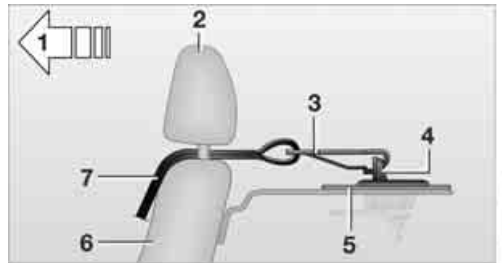

- 1 Direction of travel
- 2 Head restraint
- 3 Hook for upper retaining strap
- 4 Anchor
- 5 Rear window shelf
- 6 Seat backrest
- 7 Upper retaining strap of child-restraint system

1. Push the head restraint upward.
2. Guide the upper retaining strap between the head restraint holders.
3. Use the hook to clip the retaining strap to the anchor.
4. Push the head restraint into its lowermost position.
5. Pull the retaining strap taut.

Ignition lock

Insert the remote control into the ignition lock



Insert the remote control all the way into the ignition lock.

- ▷ Radio readiness is switched on. Individual electrical consumers can operate.

Convenient access*

If the car is equipped with convenient access, only insert the remote control into the ignition lock under special circumstances, refer to page 36.

Removing the remote control from the ignition lock

 Do not forcibly pull the remote control out of the ignition lock as this may cause damage. ◀

Before removing the remote control, push it all the way in to release the locking mechanism.

- ▷ The ignition is switched off if it was on.

Start/stop button



Pressing the start/stop button switches radio readiness or the ignition on or off.

- ▷ Manual transmission: when you press the start/stop button while the clutch is depressed, the engine starts.
M dual clutch transmission: when you press the start/stop button while the brake is depressed, the engine starts. ◀

Radio readiness

Individual electrical consumers can operate. The time and the outside temperature are displayed in the instrument cluster.

Radio readiness is switched off automatically:

- ▷ When the remote control is removed from the ignition lock
- ▷ In cars with convenient access*, by touching the surface above the door lock, refer to Locking on page 37

Ignition on

All electrical consumers can operate. The odometer and trip odometer are displayed in the instrument cluster.

- ▷ When the engine is off, please switch off the ignition and any unnecessary electrical consumers in order to preserve the battery. ◀

Radio readiness and ignition off

All indicator and warning lamps as well as displays in the instrument cluster go out.

Starting the engine

⚠ Do not run the engine in closed rooms, otherwise the inhalation of toxic exhaust gases can cause unconsciousness and death. The exhaust gases contain carbon monoxide, an odorless and colorless, but highly toxic gas. Never leave an unattended vehicle with the engine running, otherwise such a vehicle represents a potential safety hazard. Before leaving the car with the engine running, place the transmission in neutral and forcefully apply the parking brake to prevent the car from moving. ◀

⚠ Avoid frequent starting in quick succession as well as repeated start attempts in which the engine does not start. Otherwise, the fuel is not burned or incompletely burned and there is a danger of overheating and damaging the catalytic converter. ◀

Do not wait for the engine to warm up while the vehicle remains stationary. Start driving right away, but at moderate engine speeds.



Manual transmission

Remote control in the ignition lock or, with convenient access, inside the vehicle, refer to page 36.

1. Depress the brake.
2. Depress the clutch and shift to neutral.
3. Press the start/stop button.

The starter operates automatically for a certain time, and stops automatically as soon as the engine has started.

To stop the starting procedure: press the start/stop button again.

M dual clutch transmission with Drivelogic

Remote control in the ignition lock or, with convenient access, inside the vehicle, refer to page 36.

1. Depress the brake.
2. Press the start/stop button.

The engine starts with the selector level in any position. Driving off: with the engine running, move the selector level from the middle position ● in the desired direction.

Every time you start the engine, sequential mode is activated in program S3 if you lightly press the selector lever to the right to position D/S with the brake pedal depressed.

Switching off the engine

⚠ Always take the remote control with you when you leave the vehicle.

When parking, apply the parking brake forcefully, otherwise the vehicle could begin to roll. ◀

Manual transmission

1. With the car at a standstill, press the start/stop button.
2. Shift into first gear or reverse.
3. Forcefully apply the parking brake.
4. Removing the remote control from the ignition lock, refer to page 59.

M dual clutch transmission with Drivelogic

1. Press the start/stop button.
If N is engaged when you switch off the engine, you are notified visually and acoustically.
2. Forcefully apply the parking brake.

3. Remove the remote control from the ignition lock, refer to page 59. This automatically engages transmission position P.

Before driving into a car wash

The vehicle is able to roll when you perform the following steps:

1. Insert the remote control, even with convenient access, into the ignition lock.
2. Depress the brake.
3. Engage transmission position N.
4. Switch off the engine.

The vehicle can roll.

Transmission position P is engaged:

- ▷ Automatically after approx. 30 minutes
- ▷ When you remove the remote control from the ignition lock

Parking brake

The parking brake is primarily intended to prevent the vehicle from rolling while parked; it brakes the rear wheels.

Indicator lamp

 The indicator lamp is lit, and when you drive off an acoustic signal sounds in addition. The parking brake is still applied.

 Indicator lamp for Canadian models.

Applying

The lever locks in position automatically.

Releasing

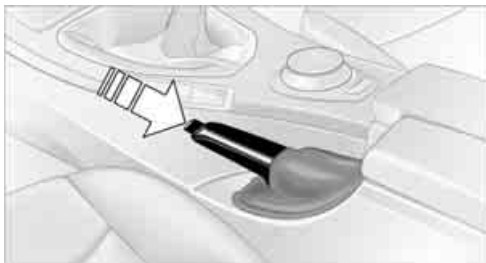

Pull slightly upwards, press the button and lower the lever.

 In exceptional cases, if the parking brake has to be used to slow or stop the car, do not pull the lever up too hard. In doing so, continuously press the button of the parking brake lever.

Otherwise, excessive force on the parking brake can lock up the rear wheels and cause the rear of the car to swerve. ◀

 To prevent corrosion and one-sided braking action, occasionally apply the parking brake lightly when the vehicle is slowly coming to a stop if the traffic conditions are suitable. The brake lamps do not light up when the parking brake is applied. ◀

Manual transmission



 When shifting into 5th or 6th gear, press the gearshift lever to the right. Otherwise the engine could be damaged if you inadvertently shift into 3rd or 4th gear. ◀

Reverse gear

Select this only when the vehicle is stationary. When the gearshift lever is pressed to the left, a slight resistance has to be overcome.

M dual clutch transmission with Drivelogic*

The concept

The M dual clutch transmission with Drivelogic is an automated manual transmission with two clutches and a partial transmission in which an electro-hydraulic system takes over clutch action and shifting.

With the M dual clutch transmission, gears are changed without interruption of the traction force.

The M dual clutch transmission is operated using the selector lever and two shift paddles on the steering wheel.

The transmission offers you the following functions:

- ▷ Selection between manual and automatic operation: sequential mode or drive mode
- ▷ Selection between different drive programs, Drivelogic, refer to page 65
- ▷ Shift Lights, refer to page 66
- ▷ Automatic downshifting and protection against selecting the wrong gear even in sequential mode
- ▷ Launch Control, refer to page 67
- ▷ Automatic throttle blip
- ▷ Low Speed Assistant

System limitations

The M dual clutch transmission is equipped with an overheating protection system that protects the clutch against extreme loads.



The indicator lamp lights up yellow when the transmission becomes too warm. Avoid high engine loads and driving off frequently. When the transmission is overheated, the indicator lamp lights up red and the fuel supply to the engine is cut off. You can-

not continue driving until the transmission has cooled down.

Avoid driving off frequently with high acceleration and do not hold the vehicle on inclines by pressing lightly on the accelerator while letting the clutch slip, as this may cause the transmission to overheat.

In traffic congestion or at very low speeds, use the Low Speed Assistant, refer to the information below.

Low Speed Assistant

The Low Speed Assistant supports you when driving at very low speeds: the vehicle moves at walking speed and automatically controls the engine speed. You can also use the Low Speed Assistant when rocking the vehicle out of deep snow. To do so, shift between reverse gear and the forward position without pressing the brake.

Activating

1. Engage a drive position.
2. Briefly tap the accelerator.

The vehicle rolls at the minimum speed. Do not press the brake continuously as this may cause the transmission to overheat.

Deactivating

Brake the vehicle to a stop to deactivate the Low Speed Assistant.

Selector lever positions



- ▷ R: reverse gear

- ▷ ●: middle position
 - ▷ N: neutral
 - ▷ +: shift up manually
 - ▷ -: shift down manually
 - ▷ D/S: change between drive mode and sequential mode

The selector lever locks in position R. In other transmission positions, it stays in the middle position; the gear positions are engaged by pressing lightly in the desired direction.

The gear position currently engaged is indicated by LEDs in the selector lever.

Shiftlock

When the vehicle is stationary, press the brake pedal before shifting out of N, otherwise the desired gear will not be engaged.

R Reverse

Select this only when the vehicle is stationary.

N Neutral

If the driving situation demands, e.g. when downshifting on a slippery road, the M dual clutch transmission automatically disengages and engages the clutch, i.e. it is not necessary to manually engage the neutral position.

 N engages when you open the driver's door while the engine is running, your safety belt is not fastened and you activate neither the brake pedal nor the accelerator. To drive off after closing the driver's door and fastening your safety belt, move the selector lever to position N first and then to the desired drive position. ◀

 N remains engaged even after the engine is switched off if you leave the remote control in the ignition lock. Use this function in an automatic car wash, for example, refer to page 61. ◀

S sequential mode

Shift up or down using the shift paddles or the selector lever. You do not need to lift your foot off the accelerator when doing so.

Shift from sequential mode to drive mode: Press the selector lever to the right in the D/S direction.

Shift back to sequential mode: shift using the shift paddles or the selector lever, or press the selector level to the right in the D/S direction again.

On a level road, you can drive off in second gear, e.g. on slippery roads.

The M dual clutch transmission assists you in the following situations:

- ▷ Upshifts and downshifts are executed only when they will result in a plausible combination of engine and vehicle speed; thus, for example, a downshift that would cause the engine to overrev will not be executed by the system.
- ▷ When the vehicle stops, the transmission automatically shifts down to first gear.
- ▷ Shortly before the vehicle slows down to below the minimum speed of the gear currently engaged, the transmission automatically shifts down without requiring your intervention.

Rapid downshifting: in sequential mode, you can skip several gears to achieve optimal acceleration. To do so, press the accelerator past the resistance point and pull the left shift paddle once or press the selector lever forward once.

D drive mode

In drive mode, all forward gears are shifted automatically.

Shift from drive mode to sequential mode: shift using the shift paddles or the selector lever, or press the selector level to the right in the D/S direction.

Shift back to drive mode: press the selector lever to the right in the D/S direction again.

Kick-down: to accelerate rapidly, e.g. when passing, press the accelerator down past the resistance point. This provides maximum acceleration.

P Park

 P engages automatically when you switch off the engine unless N is engaged and the remote control remains in the ignition lock, refer to page 59. As soon as you remove the remote control from the ignition lock, P engages regardless of the position of the selector lever. ◀

Displays in the instrument cluster



- 1 Engaged gear 1 to 7, R, N, P
- 2 Selected drive program, corresponds to the number of illuminated fields, refer to Drivelogic, page 65
- 3 The gear currently engaged is displayed together with a D in drive mode

At very low outside temperatures, this display may not be functional. The engaged driving direction is indicated by the LEDs on the selector lever.

Changing gears

Via the selector lever

- ▷ To shift up, pull back the selector lever.
- ▷ To shift down, push it forward.

Via the shift paddles on the steering wheel

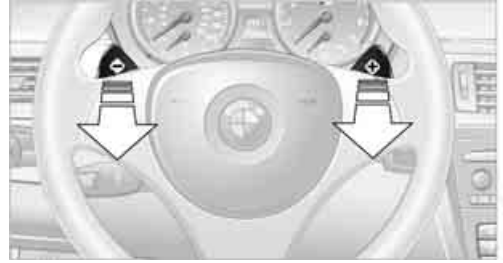

- ▷ To shift up, pull the right-hand shift paddle + briefly.
- ▷ To shift down, pull the left-hand shift paddle – briefly.

Unlocking the transmission lock manually

 If a power failure occurs, e.g. if the battery is discharged or disconnected, the transmission lock must be released manually, otherwise the rear wheels are blocked and the vehicle cannot be towed. ◀

Release the transmission lock manually for towing only and forcefully apply the parking brake beforehand to prevent the vehicle from rolling. After parking the vehicle, lock the transmission lock again.

Releasing

1. Unclip the sleeve of the selector lever.
2. Pull the sleeve up over the selector lever until the sleeve is inside out.
3. Push the black cover forward using the screwdriver from the onboard tool kit, refer to page 233.



4. Insert the screwdriver into the opening of the white lever, arrow 1.

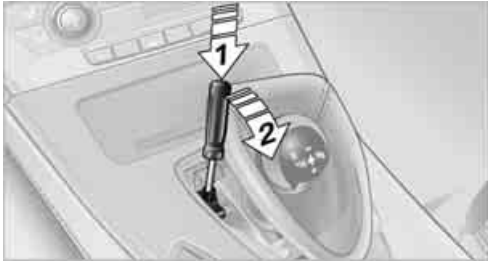

5. Pull the screwdriver back all the way, arrow 2. The transmission lock is released.
6. Carefully remove the screwdriver, for example to avoid accidentally engaging the transmission lock during towing.

⚠ After parking the vehicle, lock the transmission lock again. Otherwise there is a danger of the vehicle rolling. ◀

Locking

1. Insert the screwdriver into the opening of the white lever and press forward. The transmission lock is locked again.
2. Fold back the black cover until it engages audibly.
3. Clip the sleeve of the selector lever back into place.

Jump-starting and towing, refer to page 243.

Drivelogic

Various drive programs are available to you via Drivelogic.

After every change between sequential and drive mode, the program selected last in each case is active. Exception: after the first change

from sequential to drive mode, drive program 3 is active.

In drive mode

Five drive programs are available for selection, from winter program/balanced 1 to sporting and highly dynamic 5.

In sequential mode

You can choose between six drive programs, from winter program/balanced 1 to sporty puristic 6.

Program 6 is available when Dynamic Stability Control is deactivated, refer to page 88. If DSC is activated, the program changes from 6 to 5.

▶ To maintain driving stability, activate DSC whenever possible. ◀

Selecting the drive program via the button in the center console

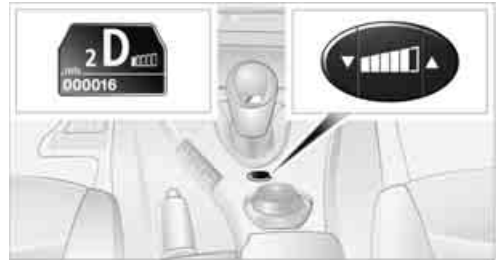

Press the button repeatedly until the desired drive program is displayed in the instrument cluster, refer to page 64.

Selecting the drive program via the button on the steering wheel

You can also activate your preferred drive program via the **M** button on the steering wheel, refer to MDrive on page 54.

You can set MDrive on the Control Display when the ignition is switched on.

iDrive, for operating principle refer to page 16.

1. Press the **MENU** button.
This opens the start menu.
2. Press the controller to open the **i** menu.

3. Select "M settings" and press the controller.
4. Select "MDrive" and press the controller.
5. Select "M DKG Drivelogic" and press the controller. The first setting is highlighted.



6. Turn the controller to set the drive mode or sequential mode.
"Unchanged" retains the current settings made outside of MDrive.
7. Press the controller to select the drive programs.
8. Turn the controller to set the drive program.
9. Press the controller.

Shift Lights

To achieve the best possible acceleration in sequential mode when using a sporty driving style, the Shift Lights in the instrument cluster indicate the best shift point just before the maximum engine speed is reached.



1. As the vehicle approaches its maximum engine speed, the yellow LEDs **1** light up consecutively to indicate the impending shift point.
2. At the latest, shift when the red LEDs **2** light up.

The LEDs flash when the maximum allowable engine speed is reached. When the maximum engine speed is exceeded, the fuel supply is cut off to protect the engine. Avoid engine speeds in this range at all costs.

Switching the Shift Lights on/off

For operating principle, refer to page 77.

1. Switch on the ignition, refer to page 59.
2. Lightly push button **1** in the turn indicator lever up or down repeatedly until the symbol appears in the display accompanied by the word "SET".



3. Press button 2.



4. Use button 1 to select:

- ▷ **ON**
Shift Lights activated.
- ▷ **OFF**
Shift Lights deactivated.

5. Press button 2.

After the ignition is switched off and the engine is restarted, the status set for the remote control in use is active, refer to Key-dependent settings on page 55.

 You can set and call up the preferred status of the Shift Lights via the MDrive, refer to page 54.

Brightness of Shift Lights

The brightness of the Shift Lights can be set using the brightness level of the instrument cluster, refer to Instrument lighting on page 101.

Launch Control

Launch Control enables you to drive off with an optimal vehicle acceleration on a high grip road surface.

 Do not use Launch Control too often, as the higher loads on the vehicle lead to premature component wear. ◀

Launch Control is available when the engine is at operating temperature, i.e. after driving continuously for at least 6 miles/10 km.

1. Press the brake while the engine is running.
2. Deactivate Dynamic Stability Control DSC, refer to page 89.
3. Select sequential mode with Drivelogic drive program 6.
4. With the vehicle stationary, press the selector lever forward and hold. A flag symbol appears in the instrument cluster.
5. Press the accelerator down all the way. The engine speed when driving off is controlled.
6. If you wish, you can adjust the drive-off engine speed by up to approx. 500 rpm:

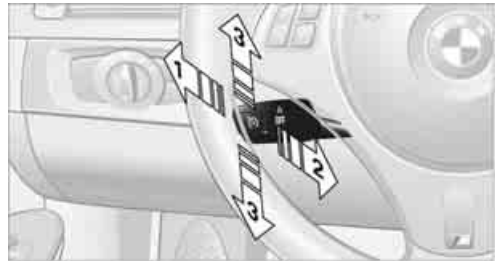

- ▷ Increase the drive-off engine speed by approx. 100 rpm: press the lever beyond the resistance point, arrow 1.
 - ▷ Decrease the drive-off engine speed by approx. 100 rpm: pull the lever beyond the resistance point, arrow 2.
 - ▷ Reset the drive-off engine speed: press the lever upward or downward, arrows 3.
7. The vehicle accelerates when you release the selector lever. Keep the accelerator pressed all the way down.
 8. The transmission shifts up automatically as long as the accelerator is pressed all the way down.

Launch Control only becomes available again after a certain distance has been driven.

Do not use Launch Control during the vehicle break-in period, refer to page 124.

 To maintain driving stability, activate DSC whenever possible. ◀

M Engine Dynamics Control

With M Engine Dynamics Control you can influence how sportily your vehicle should respond to movements of the accelerator. Three programs are available to you.

"Normal" program

In the "Normal" program, the engine responds gently to accelerator movements, which is ideal for city traffic or on snow, for example.

"Sport" program

The "Sport" program provides for a more spontaneous response of the engine to accelerator movements.

"Sport Plus"* program

In the "Sport Plus" program, the engine responds to accelerator movements with high spontaneity and uncompromising sportiness. The "Sport Plus" program can only be activated via MDrive, refer to MDrive on page 54.

Selecting a program



Press the POWER button to switch between the "Normal" and "Sport" programs.

In the "Sport" and "Sport Plus" programs, the LED in the POWER button lights up.

 You can also set and call up your preferred program via MDrive, refer to page 54.

After the ignition is switched off and the engine is restarted, the program set for the remote control in use is active, refer to Key-dependent settings on page 55.

Turn signals/ headlamp flasher

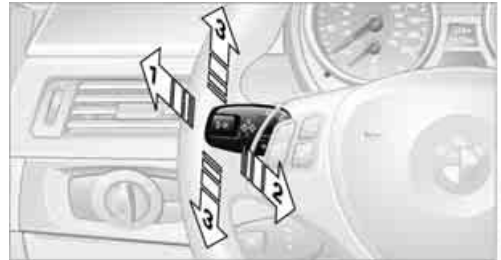

- 1 High beams
- 2 Headlamp flasher
- 3 Turn signals

Using turn signals

Press the lever beyond the resistance point.

To turn off manually, press the lever to the resistance point.

 Unusually rapid flashing of the indicator lamp indicates that a turn signal indicator has failed. ◀

Indicating a turn briefly

Press the lever as far as the resistance point for as long as you wish to indicate a turn.

Triple turn signal activation

Press the lever as far as the resistance point. The turn signals flash three times.

You can activate or deactivate this function.

iDrive, for operating principle refer to page 16.

1. Press the **MENU** button.
This opens the start menu.
2. Press the controller to open the **i** menu.
3. Select "Settings" and press the controller.

- Select "Vehicle / Tires" and press the controller.
- If necessary, move the highlight marker to the uppermost field. Turn the controller until "Lighting" is selected and press the controller.



- Select "Triple turn signal" and press the controller.

Triple turn signaling is activated.

The setting is stored for the remote control currently in use.

Wiper system



- Switching on wipers
- Switching off wipers or brief wipe
- Activating/deactivating intermittent wipe or rain sensor*
- Cleaning windshield and headlamps
- Setting speed for intermittent wipe, or sensitivity of the rain sensor

Switching on wipers

Press the lever upward, arrow 1.

The lever automatically returns to its initial position when released.

Normal wiper speed

Press once.

The system switches to operation in the intermittent mode when the vehicle is stationary.

Fast wiper speed

Press twice or press beyond the resistance point.

The system switches to normal speed when the vehicle is stationary.

Intermittent wipe or rain sensor*

If the car is not equipped with a rain sensor, the intermittent-wipe time is a preset.

If the car is equipped with a rain sensor, the time between wipes is controlled automatically and depends on the intensity of the rainfall. The rain sensor is mounted on the windshield, directly in front of the interior rearview mirror.

Activating intermittent wipe or rain sensor

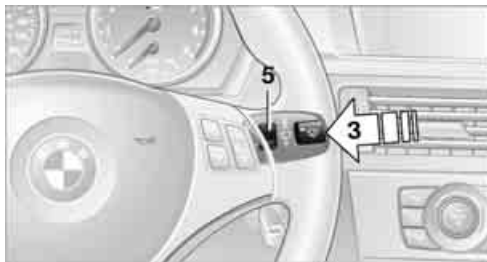

Press the button, arrow 3. The LED in the button lights up.

Setting speed for intermittent wipe or sensitivity of the rain sensor

Turn knurled wheel 5 up or down.

Deactivating intermittent wipe or rain sensor

Press the button again, arrow 3. The LED goes out.

 Deactivate the rain sensor before entering an automatic car wash. Failure to do so could result in damage caused by undesired wiper activation. ◀

Cleaning windshield and headlamps

Pull the lever, arrow 4.

Washer fluid is sprayed onto the windshield and the wipers are operated for a short time.

When the vehicle lighting system is switched on, the headlamps are cleaned at regular and appropriate intervals.

⚠ Do not use the washers if there is any danger that the fluid will freeze on the windshield. If you do, your vision could be obscured. Antifreeze should therefore be added to the fluid, refer to Washer fluid. Do not use the washers when the washer fluid reservoir is empty, otherwise you will damage the washer pump. ◀

Windshield washer nozzles

The windshield washer nozzles are heated automatically while the engine is running or the ignition is switched on.

Washer fluid

⚠ Washer fluid antifreeze is flammable. Therefore, keep it away from ignition sources and only store it in the closed original container that is kept out of reach of children, otherwise there is a risk of personal injury. Comply with the instructions on the container. ◀

Washer fluid filler neck

⚠ Only refill washer fluid when the engine is cool to avoid contact with hot engine parts. Otherwise, fluid spills constitute a fire hazard and a risk to personal safety. ◀



All washer nozzles are supplied with washer fluid by the same reservoir.

Fill with water and, if required, with a washer antifreeze, according to manufacturer's recommendations.

▶ Mix the water and antifreeze before filling the washer fluid reservoir to make sure the correct concentration is maintained. ◀

Capacity

Approx. 4.8 US quarts/4.5 liters.

Cruise control

The concept

Cruise control is available for use at speeds of approx. 20 mph or 30 km/h. The car then stores and maintains the speed that you specify using the lever on the steering column.

⚠ Do not use cruise control when driving at constant speed is prevented by adverse conditions, e.g. winding roads, dense traffic or poor road conditions due to, e.g., snow, rain, ice or loose surfaces. Otherwise you could lose control of the vehicle and cause an accident as a result. ◀

One lever for all functions

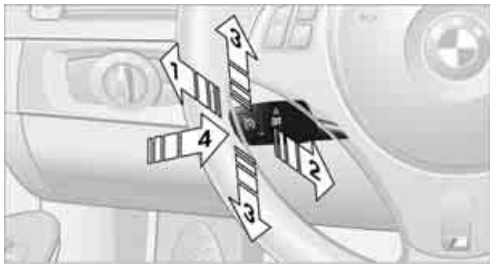

- 1 Storing and maintaining speed or accelerating
- 2 Storing and maintaining speed or decelerating
- 3 Deactivating cruise control
- 4 Resuming a speed stored beforehand

Maintaining current speed

Tap the lever, arrow **1**, or pull it briefly, arrow **2**. The car's current speed is stored and maintained. It is displayed on the speedometer and briefly in the instrument cluster. This function is not available when DSC is switched off.

On uphill gradients, it may prove impossible to maintain the set speed if current engine power output is insufficient. If engine braking power is insufficient on a downhill grade, the stored speed may be exceeded.

Increasing desired speed

Repeatedly press the lever to the resistance point or beyond, arrow **1**, until the desired speed is reached.

- ▷ Each time the lever is pressed lightly to the resistance point, the desired speed is increased by approx. 1 mph or 1 km/h.
- ▷ Each time the lever is pressed beyond the resistance point, the desired speed is increased by up to 5 mph or 10 km/h.

The system stores and maintains the speed.

Accelerating using the lever

Accelerate slightly, increase speed steadily:

Press the lever to the resistance point, arrow **1**, until the desired speed is reached.

Accelerate strongly, increase speed in intervals of 10:

Press the lever beyond the resistance point, arrow **1**, until the desired speed is reached.

The vehicle accelerates without pressure on the accelerator pedal. The system stores and maintains the speed.

Decreasing speed

Repeatedly pull the lever to the resistance point or beyond, arrow **2**, until the desired speed is displayed.

- ▷ Each time the lever is pulled to the resistance point, the desired speed is decreased by approx. 1 mph or 1 km/h.
- ▷ Each time the lever is pulled beyond the resistance point, the desired speed is reduced by up to 5 mph or 10 km/h until the minimum speed of 20 mph or 30 km/h is achieved.

The system stores and maintains the speed.

Deactivating cruise control

Tap the lever upwards or downwards, arrow **3**. The displays on the speedometer disappear.

In addition, the system is automatically deactivated:

- ▷ When you brake the vehicle
- ▷ When you shift or depress the clutch
- ▷ When you deactivate DSC
- ▷ When DSC or ABS is intervening

Cruise control is not deactivated by depressing the accelerator pedal. Once the accelerator pedal is released, the stored speed is achieved again and maintained.

Resuming a speed stored beforehand

Press the button, arrow **4**.

The stored speed is resumed and maintained.

When the ignition is switched off, the stored speed value is cleared and can no longer be called up.

Displays in the instrument cluster



- 1 Stored speed
- 2 Selected speed is displayed briefly

Everything under control

Odometer, outside temperature display, clock

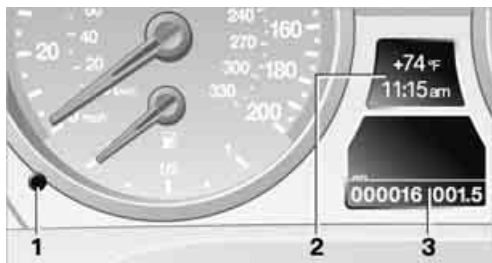

- 1 Knob in the instrument cluster
- 2 Outside temperature and clock, refer to Computer on page 74
- 3 Odometer and trip odometer

Knob in the instrument cluster

- ▷ To reset the trip odometer while the ignition is switched on
- ▷ To display the time, outside temperature and odometer briefly while the ignition is switched off

Units of measure

To select the respective units of measure, miles or km for the odometer as well as °F or °C for the outside temperature, refer to page 77.

The setting is stored for the remote control currently in use.

Time, outside temperature display

Setting the time, refer to page 80.

Outside temperature warning

When the displayed temperature sinks to approx. +37 °F / +3 °C, a signal sounds and a warning lamp lights up. There is an increased risk of black ice.

 Black ice can also form at temperatures above +37 °F / +3 °C. You should therefore drive carefully on bridges and shaded

roads, for example, otherwise there is an increased risk of an accident. ◀

Odometer and trip odometer

Resetting trip odometer:

With the ignition switched on, press button 1 in the instrument cluster.

When the vehicle is parked

If you still want to view the time, outside temperature and odometer reading briefly after the remote control has been taken out of the ignition lock:

Press button 1 in the instrument cluster.

Tachometer



The prewarning field, arrow 1, and the red warning field, arrow 2, change in relation to the engine temperature. The permissible engine speed increases with increased engine temperature. Avoid engine speeds in the prewarning field, if possible.

Never drive at engine speeds in the red warning field. In this range, the engine speed is limited to protect the engine.

Coolant temperature

A warning lamp will come on if the coolant, and therefore the engine, becomes too hot. In addition, a message will appear on the Control Display.

Check coolant level, refer to page 226.

Engine oil temperature



When the engine is at normal operating temperature, the engine oil temperature is between approx. 175°F / 80°C and approx. 250°F / 120°C.

If the engine oil temperature is too high, a message appears on the Control Display.

Fuel gauge



Fuel tank capacity: approx. 16.6 US gal/ 63 liters.

You can find information on refueling on page 214.

If the tilt of the vehicle varies for a longer period, when you are driving in mountainous areas, for example, the indicator may fluctuate slightly.

Reserve

Once the fuel level has fallen to the reserve zone, a message briefly appears on the Control Display and the cruising range for the remaining amount of fuel is displayed on the computer. Under a cruising range of approx. 30 miles/ 50 km, the message remains in the Control Display.

 Refuel as soon as possible once your cruising range falls below 30 miles/ 50 km, otherwise engine functions are not ensured and damage can occur. ◀

Computer

Displays in the instrument cluster

Calling up information



Press the button in the turn indicator lever. The following items of information are displayed in the order listed:

- ▷ Cruising range
- ▷ Oil level, refer to Checking oil level on page 223
- ▷ Average fuel consumption
- ▷ Speed
- ▷ No information

 M dual clutch transmission:
Outside temperature, time, cruising

range, oil level, average fuel consumption and speed appear in the top display. ◀

To set the corresponding units of measure, refer to Units of measure on page 77.

Cruising range

Displays the estimated cruising range available with the remaining fuel. The range is calculated on the basis of the way the car has been driven over the last 18 miles/30 km and the amount of fuel currently in the tank.

 Refuel as soon as possible once your cruising range falls below 30 miles/50 km, otherwise engine functions are not ensured and damage can occur. ◀

Average fuel consumption

The average fuel consumption is calculated for the time during which the engine is running.

With the trip computer, refer to page 76, you can have the average consumption for another trip displayed.

To reset average fuel consumption: press the button in the turn indicator lever for approx. 2 seconds.

Displays on the Control Display

You can also call up the computer via iDrive; for operating principle refer to page 16.

1. Press the **MENU** button.
This opens the start menu.
2. Move the controller to the right to call up "Navigation".
3. If necessary, move the highlight marker to the uppermost field. Turn the controller

until "Car Data" is selected and press the controller.



4. Select "Onboard info" and press the controller.



- ▷ Estimated time of arrival at destination:
 - ▷ Manually enter a distance in the computer, refer to information further below
 - ▷ Enter a destination in the navigation system, refer to page 136
- ▷ Cruising range
- ▷ Distance to destination:
 - ▷ Manually enter a distance in the computer, refer to information further below
 - ▷ Enter a destination in the navigation system, refer to page 136
- ▷ Average speed
- ▷ Average fuel consumption

Resetting values

You can reset the values for average speed and average consumption:

1. Select the respective menu item and press the controller.
2. Press the controller again to confirm your selection.

Entering a distance manually

1. Select "Distance to dest." and press the controller.

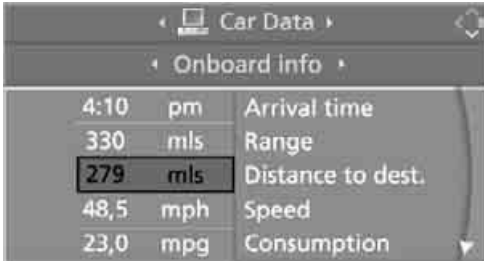

2. Turn the controller to select the distance to your destination.
 3. Press the controller to apply the setting.
- The distance is automatically entered during destination guidance.

Trip computer

The trip computer is suitable e.g. for a holiday trip.

iDrive, for operating principle refer to page 16.

1. Press the **MENU** button.
This opens the start menu.
2. Call up "Navigation".
3. Select "Car Data" and press the controller.
4. Select "Trip computer" and press the controller.

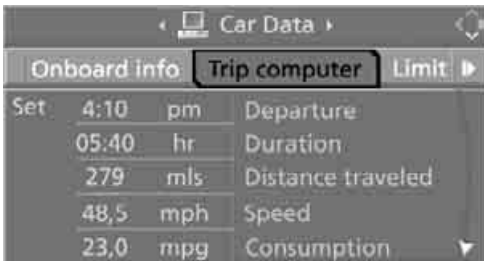

- ▷ Departure time
- ▷ Driving time
- ▷ Distance traveled
- ▷ Average speed
- ▷ Average fuel consumption

Switching trip computer on/off and resetting all values to zero:

1. Select "Set" and press the controller.
2. Select the desired menu item and press the controller.

Display options

You can display the computer or the trip computer in the assistance window.

1. Move the controller to the right to change to the assistance window and press the controller.
2. Select a menu item:
 - ▷ "Onboard info"
 - ▷ "Trip computer"
3. Press the controller.



Settings and information

Operating principle



- 1 Button for:
 - ▷ Selecting display
 - ▷ Setting values
- 2 Button for:
 - ▷ Confirming selected display or set values
 - ▷ Calling up computer information 74
- 3 When the lights are on: instrument lighting brightness 101
- 4 Calling up Check Control 83
- 5 Setting the time 80
- 6 Setting the date 82
- 7 Viewing service requirement display 78
- 8 Switching Shift Lights* on/off 66

Exiting displays

The outside-temperature reading and the time reappear when you press button 2 or if you make no entries within approx. 15 seconds. If required, complete the current setting first.

- 4. Select "Language / Units" and press the controller.
- 5. If necessary, move the highlight marker to the uppermost field. Turn the controller until "Units" is selected and press the controller.

Units of measure

You can set units of measure.

iDrive, for operating principle refer to page 16.

- 1. Press the **MENU** button.
This opens the start menu.
- 2. Press the controller to open the **i** menu.
- 3. Select "Settings" and press the controller.

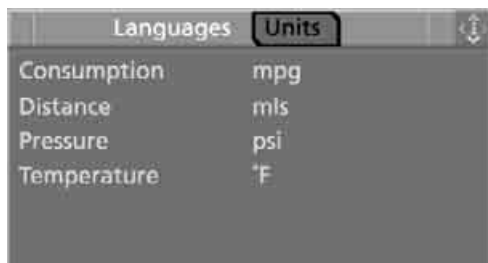

6. Select the desired menu item and press the controller.
7. Select the desired measurement unit and press the controller.
The setting is stored for the remote control currently in use.

 The extent of service work required can be read out from the remote control by your BMW Service Advisor. ◀

For certain maintenance operations, you can view the respective distance remaining or due date individually in the instrument cluster.

Service requirements



The remaining driving distance and the date of the next scheduled service are displayed briefly immediately after you start the engine or switch on the ignition.



1. Switch on the ignition, refer to page 59.
2. Push button 1 in the turn indicator lever up or down repeatedly until the appropriate symbol appears in the display, accompanied by the words "SERVICE-INFO".
3. Press button 2.
4. Use button 1 to scroll through the individual service items.

Possible displays

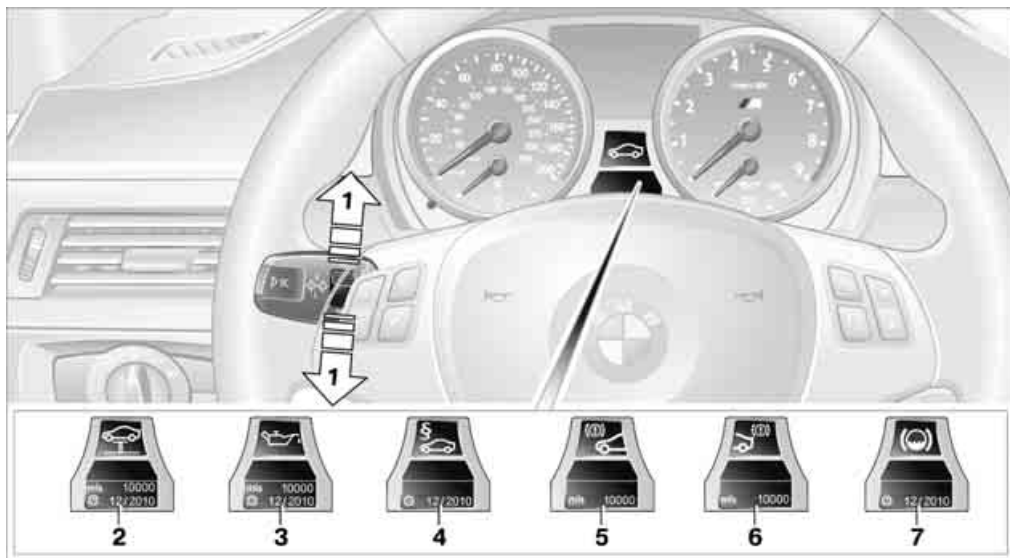

1 Button for selecting functions

2 Service requirements

- 3 Engine oil
- 4 Roadworthiness test*
- 5 Front brake pads
- 6 Rear brake pads

Supplementary information

You can call up detailed information about the maintenance regimen on the Control Display. iDrive, for operating principle refer to page 16.

1. Press the **MENU** button.
This opens the start menu.
2. Press the controller to open the **i** menu.
3. Select "Info sources" and press the controller.
4. Select "Service Info" and press the controller.
5. If necessary, move the highlight marker to the uppermost field. Turn the controller until "Service requirements" is selected and press the controller.

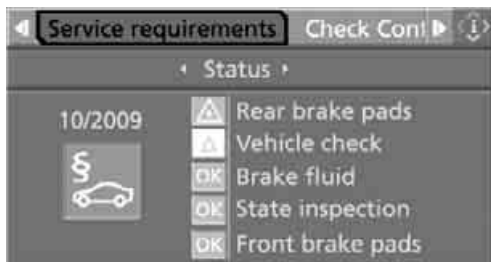

6. If necessary, move the highlight marker to the second field from the top. Turn the controller until "Status" is selected and press the controller.

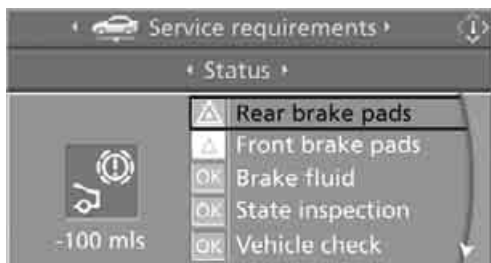

7 Brake fluid

The sequence of displayed service items may vary. The data for the next service appointment is shown first.

A list of selected maintenance operations and, if applicable, inspections required by law is displayed.

You can request more detailed information on every entry:

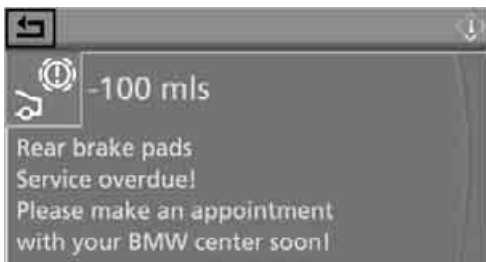

Select the entry and press the controller.



To exit from the menu:

Select the  arrow and press the controller.

Symbols

-  No service is currently required.
-  The deadline for service or a legally mandated inspection is approaching. Please schedule a service appointment.
-  The service deadline has already passed.

Entering deadlines for legally required inspections*

Make sure the date on the Control Display is always set correctly, refer to page 82, otherwise the effectiveness of Condition Based Service CBS is not ensured.

iDrive, for operating principle refer to page 16.

1. Press the **MENU** button.
This opens the start menu.
2. Press the controller to open the **i** menu.
3. Select "Info sources" and press the controller.

4. Select "Service Info" and press the controller.
5. If necessary, move the highlight marker to the uppermost field. Turn the controller until "Service requirements" is selected and press the controller.
6. Select "Status" and press the controller.
7. Select "State inspection" and press the controller.

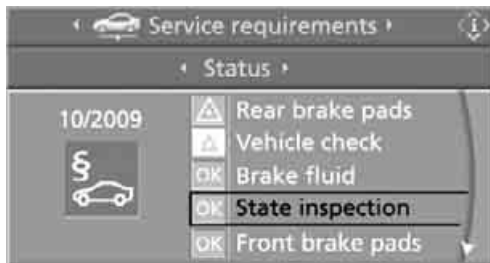

8. Select "Set service date" and press the controller. The month is highlighted.
9. Turn the controller to make the adjustment.



10. Press the controller to apply the setting. The year is highlighted.
11. Turn the controller to make the adjustment.
12. Press the controller to apply the setting. The date entry is stored.

To exit from the menu:

Select  and press the controller.

More information on the BMW Maintenance System can be found on page [227](#).

Clock

The settings are stored for the remote control currently in use, refer also to Personal Profile on page [28](#).

Setting the time

In the instrument cluster

To set the 12h/24h format, refer to Setting the 12h/24h format below.



1. Push button **1** in the turn indicator lever up or down repeatedly until the appropriate symbol appears in the display, accompanied by the time and the word "SET".
2. Press button **2**.
3. Use button **1** to set the hours.
4. Press button **2** to confirm the entry.
5. Use button **1** to set the minutes.
6. Press button **2** to confirm the entry.
7. Press button **2**.
The system accepts the new time.

Via iDrive

iDrive, for operating principle refer to page [16](#).

1. Press the **MENU** button once or twice until the start menu appears.



2. Press the controller to open the **i** menu.
3. Turn the controller until "Settings" is selected and press the controller.



4. Turn the controller until "Time / Date" is selected and press the controller.



5. If necessary, move the controller forwards to move the highlight marker to the uppermost field.



6. Turn the controller until "Time" is selected and press the controller.

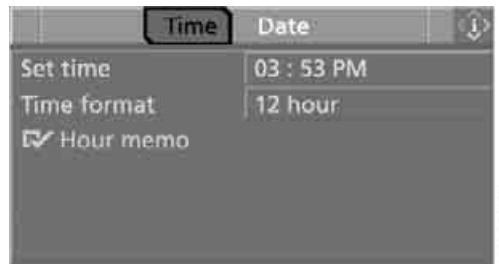

7. Turn the controller until "Set time" is selected and press the controller.

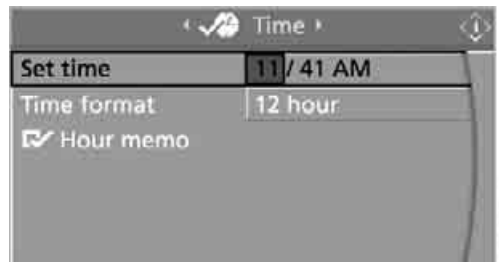

Adjusting settings

8. Turn the controller to set the hours and press the controller.
9. Turn the controller to set the minutes and press the controller.

The system accepts the new time.

Switching on the hour signal*

You will hear three tones just before each full hour.

Select "Hour memo" and press the controller.
 The hour signal is activated.

Setting the 12h/24h format

iDrive, for operating principle refer to page 16.

1. Press the **MENU** button.
This opens the start menu.
2. Press the controller to open the **i** menu.
3. Turn the controller until "Settings" is selected and press the controller.
4. Turn the controller until "Time / Date" is selected and press the controller.
5. Select "Time format" and press the controller.
6. Select the desired format and press the controller.

Date

The settings are stored for the remote control currently in use, refer also to Personal Profile on page 28.

Setting the date

In the instrument cluster

To set the dd/mm or mm/dd date format, refer to Setting the date format below.



1. Push button **1** in the turn indicator lever up or down repeatedly until the appropriate symbol appears in the display, accompanied by the date and the word "SET".
2. Press button **2**.
3. Use button **1** to set the day of the month.
4. Press button **2** to confirm the entry.

5. Set the month and the year in the same way.
6. Press button **2**.
The system stores the new date.

Via iDrive

iDrive, for operating principle refer to page 16.

1. Press the **MENU** button.
This opens the start menu.
2. Press the controller to open the **i** menu.
3. Turn the controller until "Settings" is selected and press the controller.
4. Select "Date" and press the controller.



5. Select "Set date" and press the controller.
The first date display setting is selected.
6. Turn the controller to make the adjustment.
7. Press the controller to apply the setting.
The next setting is highlighted.
8. Make the remaining adjustments. After the last adjustment, the date is stored.

Setting the date format

iDrive, for operating principle refer to page 16.

1. Press the **MENU** button.
This opens the start menu.
2. Press the controller to open the **i** menu.
3. Turn the controller until "Settings" is selected and press the controller.
4. Turn the controller until "Time / Date" is selected and press the controller.
5. Select "Date format" and press the controller.
6. Select the desired format and press the controller.

Check Control

The concept

The Check Control monitors vehicle functions and alerts you to any malfunctions in the systems monitored. Such a Check Control message includes indicator and warning lamps in the instrument cluster and, in some circumstances, an acoustic signal as well as text messages at the bottom of the Control Display.

Indicator and warning lamps



Indicator and warning lamps can light up in a variety of combinations and colors.



⚠ indicates that Check Control messages have been stored. You can view the Check Control messages whenever it is convenient for you.

Explanatory text messages



Text messages at the lower edge of the Control Display explain the meaning of the displayed indicator and warning lamps.

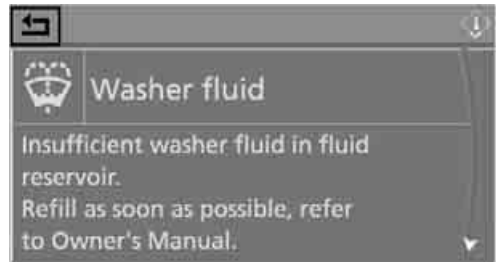

For most Check Control messages, you can view more information later, e.g. regarding the cause of a malfunction and how to respond, refer to page 84.

In urgent cases, this information will be shown as soon as the corresponding lamp comes on.

To exit the displayed information: Select the ↶ arrow and press the controller.

Hiding Check Control messages

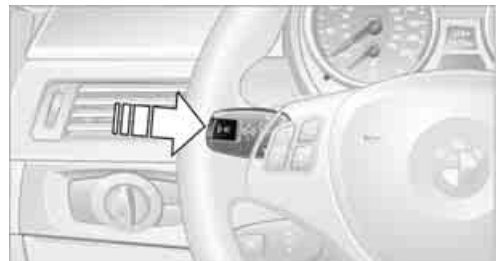

Press the button in the turn indicator lever.

Some Check Control messages are displayed until the malfunctions have been rectified. They cannot be hidden. If several malfunctions occur

at the same time, they are displayed in succession.

 They are marked with the symbol shown here.

Other messages are automatically hidden after approx. 20 seconds, but are kept in memory.

 They are marked with the symbol shown here.

Viewing stored Check Control messages



1. Push button **1** in the turn indicator lever up or down repeatedly until the appropriate symbol appears in the display, accompanied by the words "CHECK CONTROL".
2. Press button **2**. "CHECK OK" appears if there are no Check Control messages. If a Check Control message has been stored, the corresponding lamp comes on. It is accompanied by a text message on the Control Display.
3. Push button **1** to check for other messages.
4. Press button **2**. The display again shows the outside temperature and the time.

Viewing more information later

iDrive, for operating principle refer to page 16.

1. Press the **MENU** button. This opens the start menu.
2. Press the controller to open the **i** menu.

3. Select "Info sources" and press the controller.



4. Select "Service Info" and press the controller.
5. If necessary, move the highlight marker to the uppermost field. Turn the controller until "Check Control messages" is selected and press the controller.

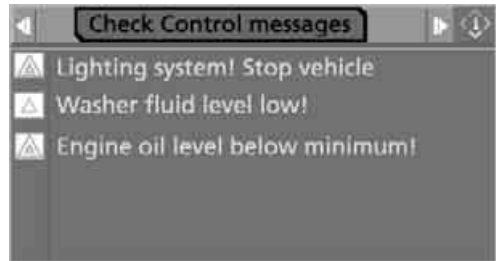

6. Select a text message and press the controller.

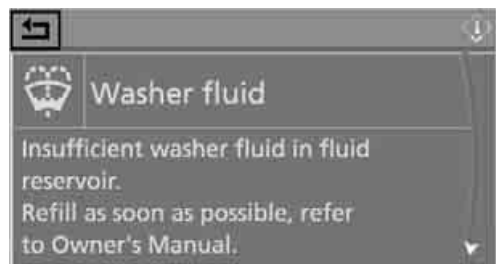

To exit the display:
Select  and press the controller.

Speed limit

You can enter a speed, and a Check Control message will indicate when you reach this speed. This enables you, for example, to

receive warnings if you exceed a speed limit in an urban area.

After the warning, you are only alerted to reaching this speed a second time if your vehicle speed falls below it again by at least 3 mph or 5 km/h.

iDrive, for operating principle refer to page 16.

1. Press the **MENU** button.
This opens the start menu.
2. Call up "Navigation".
3. Select "Car Data" and press the controller.
4. Select "Limit" and press the controller.



Setting or changing the limit

1. Select speed value and press the controller.
2. Turn the controller to set the limit.
3. Press the controller to apply the setting.

Applying your current speed as limit

Select "Select current speed" and press the controller. The system adopts your current speed as the limit.

Activating the limit

Select "On" and press the controller.

Limit is activated.

Stopwatch

iDrive, for operating principle refer to page 16.

1. Press the **MENU** button.
This opens the start menu.
2. Call up "Navigation".
3. Select "Car Data" and press the controller.

4. Select "Stopwatch" and press the controller.

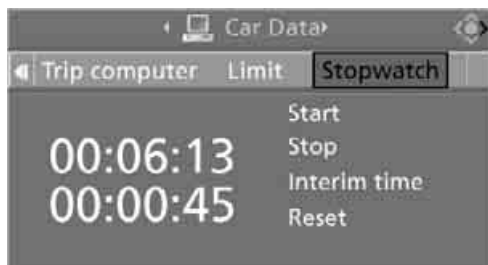

Starting, stopping or resetting

- ▷ Select "Start" and press the controller.
The stopwatch starts at the displayed time.
- ▷ Select "Reset" and press the controller.
The stopwatch is reset and restarts if it was running beforehand.
- ▷ Select "Stop" and press the controller.
This stops the timer.

Taking an interim time reading

Select "Interim time" and press the controller. The interim time appears below the ongoing primary stopwatch count.

 All of the remaining functions remain available at all times while the stopwatch is running. The stopwatch continues operation in the background. ◀

Altering settings

Language on the Control Display

The language of the Control Display can be set. The setting is stored for the remote control currently in use.

iDrive, for operating principle refer to page 16.

1. Press the **MENU** button.
This opens the start menu.
2. Press the controller to open the **i** menu.
3. Turn the controller until "Settings" is selected and press the controller.
4. If necessary, move the highlight marker to the uppermost field. Turn the controller

until "Language" is selected and press the controller.

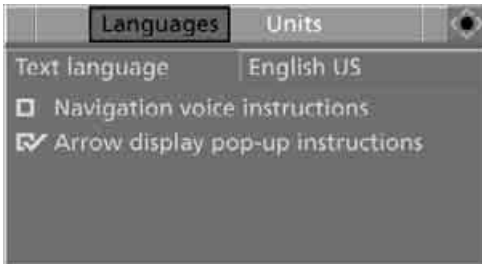

5. Select "Text language" and press the controller. You can switch to another language for the display texts and navigation messages.
6. Select and activate the desired language by pressing the controller.

Brightness of the Control Display

The brightness is automatically adapted to the ambient lighting conditions. Note, however, that you can change the basic setting while the low beams are switched on. The setting is stored for the remote control currently in use.

iDrive, for operating principle refer to page 16.

1. Open the start menu.
2. Press the controller to open the **i** menu.
3. Turn the controller until "Settings" is selected and press the controller.
4. If necessary, move the highlight marker to the uppermost field. Turn the controller until "Brightness" is selected and press the controller.



5. Turn the controller until the desired setting is reached.

Park Distance Control PDC*

The concept

The PDC assists you with maneuvering in tight parking spaces. Acoustic signals and a visual indicator warn you of the presence of an object behind your vehicle. To measure the distance, there are four ultrasonic sensors in the bumpers.

These sensors have a range of approx. 6.5 ft/ 2 m. However, an acoustic warning does not sound until an object is approx. 24 in/60 cm from the corner sensors, or approx. 5 ft/1.50 m from the center sensors.

 PDC is a parking aid that can indicate objects when they are approached slowly, as is usually the case when parking. Avoid approaching an object at high speed, otherwise physical circumstances may lead to the system warning being issued too late. ◀

Switching on automatically

With the engine running or the ignition switched on, the system is activated after approx. 1 second when you engage reverse gear. Wait this short period before driving.

Switching off automatically

After approx. 165 ft/50 m of driving or over approx. 20 mph/30 km/h, the system switches off and the LED goes out.

Signal tones

When nearing an object, its position is indicated correspondingly by an interval tone. As the distance between vehicle and object decreases, the intervals between the tones become shorter. If the distance to the nearest object falls to below roughly 1 ft/30 cm, then a continuous tone sounds.

An interval tone is interrupted after approx. 3 seconds

- ▷ if you stop in front of an object that has been detected by only one of the corner sensors
- ▷ if you are driving parallel to a wall.

Malfunction



The indicator lamp in the instrument cluster comes on. PDC is malfunctioning. A message appears on the Control Display. Have the system checked.

To avoid this problem, keep the sensors clean and free of ice or snow in order to ensure that they will continue to operate effectively. When using a high-pressure cleaner, do not spray the sensors for extended periods of time and only from a distance of at least 4 in/10 cm.

PDC with visual warning

You can also have the system show distances to objects on the Control Display. The contours of distant objects are shown on the Control Display even before the acoustic signal sounds. The setting is stored for the remote control currently in use.

iDrive, for operating principle refer to page 16.

1. Press the **MENU** button.
This opens the start menu.
2. Press the controller to open the **i** menu.
3. Select "Settings" and press the controller.



4. Select "Vehicle / Tires" and press the controller.
5. If necessary, move the highlight marker to the uppermost field. Turn the controller

until "PDC" is selected and press the controller.

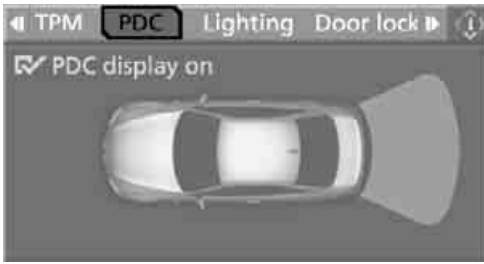

6. Select "PDC display on" and press the controller.

The PDC screen is activated.

The display is shown on the Control Display as soon as PDC is activated.

System limitations

 Even with PDC, final responsibility for estimating the distance between the vehicle and any obstructions always remains with the driver. Even when sensors are provided, there is a blind spot in which objects can no longer be detected. The system is also subject to the physical limits that apply to all forms of ultrasonic measurement, such as those encountered with trailer towbars and hitches, thin or wedge-shaped objects, etc. Low objects that have already been displayed, e.g. curbs, can disappear again from the detection area of the sensors before or after a continuous tone sounds. Higher, protruding objects, e.g. ledges, cannot be detected. Therefore, always drive cautiously, otherwise there is a risk of personal injury or property damage. Loud sound sources outside or inside the car can drown out the PDC signal. Therefore, always drive cautiously, otherwise there is a risk of personal injury or property damage. ◀

Driving stability control systems

Your BMW has a number of systems that help to maintain the vehicle's stability even in adverse driving conditions.

Antilock Brake System ABS

ABS prevents locking of the wheels during braking. Safe steering response is maintained even during full braking. Active safety is thus increased.

The ABS is operational every time you start the engine. Braking safely, refer to page 125.

Electronic brake-force distribution

The system controls the brake pressure in the rear wheels to ensure stable braking behavior.

Brake assist

When you apply the brakes rapidly, this system automatically produces the maximum braking force boost and thus helps to achieve the shortest possible braking distance during full braking. This system exploits all of the benefits provided by ABS.

Do not reduce the pressure on the brake for the duration of the full braking application.

Dynamic Stability Control DSC

DSC optimizes driving stability and traction. In addition, the system recognizes unstable driving situations such as understeering and oversteering, and helps keep the vehicle on a safe course within physical limits by reducing engine power and applying the brakes on individual wheels.

 The laws of physics cannot be repealed, even with DSC. An appropriate driving style always remains the responsibility of the driver. Therefore, do not reduce the additional safety margin again by taking risks, as this could result in an accident. ◀

M Dynamic Mode MDM*

M Dynamic Mode is a mode of the Dynamic Stability Control DSC that permits greater longitudinal and lateral acceleration when driving on dry surfaces, yet with reduced driving stability. Only at the absolute limit of stability does the system intervene to stabilize the vehicle by reducing engine power and applying the brakes on the wheels. In such situations, additional

corrective steering maneuvers may be necessary.

M Dynamic Mode is switched off every time the engine is restarted.

 When the M Dynamic Mode is on, stabilizing measures are performed to a limited degree only. Take action yourself, otherwise there is a risk of an accident. ◀

 To maintain vehicle stability, drive with the DSC activated and the M Dynamic Mode deactivated whenever possible. ◀

Activating MDM

Press the  button on the steering wheel, refer to MDrive* on page 54. The MDM indicator lamp in the instrument cluster lights up if you previously selected the M Dynamic Mode MDM in MDrive.

When the ignition is on, you can set the M Dynamic Mode via MDrive on the Control Display.

iDrive, for operating principle refer to page 16.

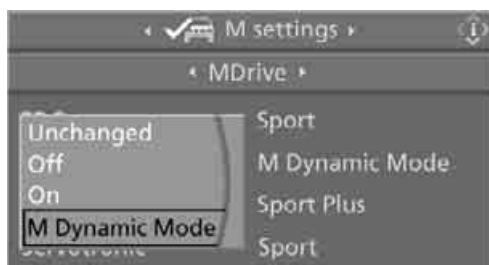

1. Press the **MENU** button.
This opens the start menu.
2. Press the controller to open the **i** menu.
3. Select "M settings" and press the controller.
4. Select "MDrive" and press the controller.
5. Select "DSC" and press the controller.
6. Select "M Dynamic Mode" and press the controller.



Deactivating MDM

Press the  button on the steering wheel again; the MDM indicator lamp in the instrument cluster goes out.

For better control

-  The indicator lamp goes out briefly after MDM the engine is started.
-  If the indicator lamp lights up: M Dynamic Mode is activated.

 The indicator lamp lights up permanently and the DSC indicator lamp flashes. M Dynamic Mode is controlling the drive and braking forces.

Deactivating DSC



Press the DSC OFF button for longer than approx. 1 second; the indicator lamps for DSC in the instrument cluster light up. Stabilizing and drive-output promoting actions are no longer executed.

You may find it useful to briefly deactivate DSC under the following exceptional circumstances:

- ▷ When driving uphill on snow-covered roads, in slush or on unplowed, snow-covered roads
- ▷ When rocking a stuck vehicle free or starting off in deep snow or on loose ground
- ▷ When driving with snow chains

To increase vehicle stability, activate DSC again as soon as possible.

Activating DSC

Press the DSC OFF button again; the indicator lamps in the instrument cluster go out.

For better control



If the indicator lamp flashes:
DSC is regulating the drive and braking forces.



If the indicator lamps are on:
DSC is deactivated.



Electronic Damper Control EDC*

The concept

Whenever there is a change in any significant parameter such as road surface quality or in an operating condition such as steering, braking, etc., the damping automatically adjusts to the new conditions in fractions of a second.

You can select between three programs.

"Comfort" program

Select the "Comfort" program if you want comfort-oriented control of the shock absorbers.

"Normal" program

The "Normal" program offers control that is balanced between comfort and sportiness.

"Sport" program

Select the "Sport" program if you want consistently sporty control of the shock absorbers.

Selecting a program



Press the EDC button repeatedly:

- ▷ "Comfort": LED off:
- ▷ "Normal": one LED lights up.

- ▷ "Sport": both LEDs light up.

Each time the engine is started, the program set for the remote control in use is active, refer to Key-dependent settings on page 55.

 You can also set and call up your preferred program via MDrive, refer to page 54.

Drive-off assistant

The drive-off assistant enables you to drive off smoothly on uphill gradients. It is not necessary to use the parking brake for this.

1. Hold the car in place by depressing the brake.
2. Release the brake and drive off without delay.



The drive-off assistant holds the car in place for approx. 2 seconds after the brake is released. Drive off without delay after releasing the brake. Otherwise, the drive-off assistant will no longer hold the car in place after approx. 2 seconds and the car will start to roll backwards. ◀

Flat Tire Monitor FTM*

The concept

The Flat Tire Monitor detects pressure loss in a tire by comparing the rotating speeds of the individual tires while moving.

In the event of pressure loss, the rolling circumference changes and, thus, the rotating speed of the affected wheel. This change is detected and is reported as a flat tire.

Functional requirement

In order to assure the reliable reporting of a flat tire, the system must be initialized for the correct tire inflation pressure.



The system must be reinitialized each time a tire inflation pressure has been corrected or a wheel or tire has been changed. ◀

System limitations

 The Flat Tire Monitor is unable to warn the driver of sudden, severe tire damage caused by external factors, nor can it identify the gradual loss of pressure that will inevitably occur in all four tires over a lengthy period of time. ◀

In the following situations, the system could be delayed or malfunction:

- ▷ System has not been initialized
- ▷ Driving on snowy or slippery road surface
- ▷ Performance-oriented style of driving: slip in the drive wheels, high lateral acceleration
- ▷ Snow chains are attached

Initializing the system

 The initialization is completed during driving, which can be interrupted at any time. When driving resumes, the initialization is continued automatically. Do not initialize the system while snow chains are attached. ◀

Using the button in the center console

1. Start the engine, but do not start driving.
2. Press the button for approx. 4 seconds until the warning lamp in the instrument cluster lights up yellow. Warning lamp, refer to Indication of a flat tire on page 92. The message "Initializing FTM..." appears on the Control Display for several seconds.



3. Start to drive. Initialization is completed while the car is moving, without any feedback.

Via iDrive

For operating principle, refer to page 16.

1. Press the **MENU** button. This opens the start menu.
2. Press the controller to open the **i** menu.
3. Turn the controller until "Settings" is selected and press the controller.



4. Select "Vehicle / Tires" and press the controller.
5. If necessary, move the highlight marker to the uppermost field. Turn the controller until "FTM" is selected and press the controller.

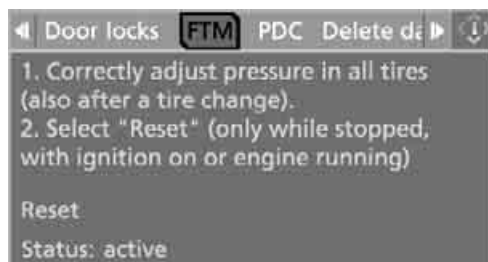

6. Start the engine, but do not start driving.
7. Select "Reset" and press the controller.
8. Select "Yes" and press the controller.



- Start to drive.
Initialization is completed while the car is moving, without any feedback.

Indication of a flat tire



The warning lamps come on in yellow and red. A message appears on the Control Display. In addition, an acoustic signal sounds. There is a flat tire or substantial loss of tire pressure.

- Reduce your speed and carefully stop the car. Avoid sudden braking and steering maneuvers.
- Identify the damaged tire. To do so, check the tire pressure using the M Mobility System, refer to Producing the tire inflation pressure on page 238.
- Repair the flat tire with the M Mobility System, refer to page 238.

Malfunction



The warning lamps come on in yellow. A message appears on the Control Display. The Flat Tire Monitor has a malfunction or has failed. Have the system checked as soon as possible.

Tire Pressure Monitor TPM*

The concept

TPM checks the inflation pressures of the four mounted tires. The system notifies you if there is a significant loss of pressure in one or more tires.

Functional requirement

In order to assure the reliable reporting of a flat tire, the system must be reset while all tire inflation pressures are correct.

Always use wheels with TPM electronics. Otherwise, the system may malfunction.



Each time a tire inflation pressure has been corrected or a wheel or tire has been changed, reset the system. ◀

System limitations



TPM cannot warn you in advance of sudden severe tire damage caused by outside influences. ◀

The system does not work correctly if it has not been reset; for example, a flat tire may be indicated even though the tire inflation pressures are correct.

The system is inactive and cannot indicate a flat tire if a wheel without TPM electronics has been mounted, or if TPM is temporarily malfunctioning due to other systems or devices using the same radio frequency.

Status indicator on the Control Display

The color of the wheels represents the status of the tires and the system.

TPM takes into account that tire pressures change while the vehicle is being driven. The tire pressures do not need to be corrected unless the TPM instructs you to do so by means of color indicators.

Green

The tire inflation pressure corresponds to the established target value.

"TPM active" appears on the Control Display.

One wheel yellow

There is a flat tire or substantial loss of tire pressure in the indicated tire. A message appears on the Control Display.

All wheels yellow

There is a flat tire or substantial loss of tire pressure in several tires. A message appears on the Control Display.

Gray

The system cannot detect a puncture.

Possible reasons for this:

- ▷ TPM is being reset
- ▷ Temporary malfunction caused by systems or devices using the same radio frequency
- ▷ Malfunction

Resetting the system

 Each time a tire inflation pressure has been corrected or a wheel or tire has been changed, reset the system. ◀

Using the button in the center console

1. Start the engine, but do not start driving.
2. Press the button for approx. 4 seconds until the warning lamp in the instrument cluster lights up yellow. Warning lamp, refer to Message for low tire inflation pressure on page 94.
The message "Resetting TPM..." appears on the Control Display for several seconds.



3. Start to drive.
After driving a few minutes, the set inflation pressures in the tires are accepted as the target values to be monitored. The system reset is completed during your drive, and can be interrupted at any time. When driving resumes, the reset is continued automatically. The indicator lamp goes out after the system reset is completed.

Via iDrive

For operating principle, refer to page 16.

1. Press the **MENU** button.
The start menu is called up.
2. Press the controller to open the **i** menu.

3. Select "Settings" and press the controller.



4. Select "Vehicle / Tires" and press the controller.
5. If necessary, move the highlight marker to the uppermost field. Turn the controller until "TPM" is selected and press the controller.

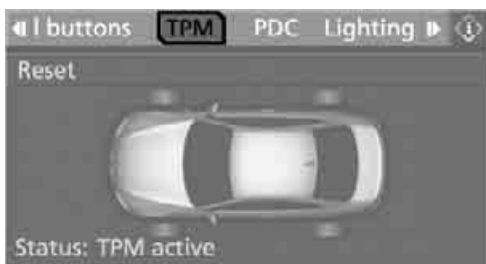

6. Start the engine, but do not start driving.
7. Select "Reset" and press the controller.
8. Select "Yes" and press the controller.

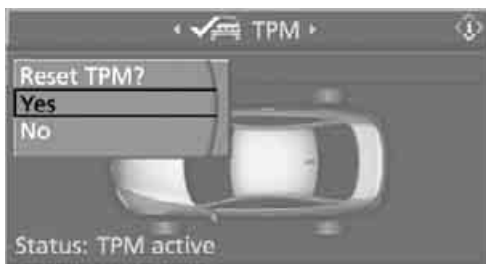

9. Start to drive.
The wheels are shown in gray and "Resetting TPM..." is displayed.

After driving a few minutes, the set inflation pressures in the tires are accepted as the target values to be monitored. The system reset is completed during your drive, and can be inter-

rupted at any time. When driving resumes, the reset is continued automatically. On the Control Display, the wheels are shown in green and "Status: TPM active" is displayed again.

 If a flat tire is detected while the system is resetting and determining the inflation pressures, all wheels on the Control Display are displayed in yellow. The message "Tire low!" is shown. ◀

Message for low tire inflation pressure

 The warning lamps come on in yellow and red. A message appears on the Control Display. In addition, a signal sounds. There is a flat tire or substantial loss of tire pressure.

1. Reduce your speed and carefully stop the car. Avoid sudden braking and steering maneuvers.
2. If all four wheels are shown in yellow, identify the damaged wheel on the vehicle.
3. Repair the flat tire with the M Mobility System, refer to page 237.

Have the tire replaced by a BMW center or a workshop that is informed in the handling of TPM and that works according to BMW repair procedures with correspondingly trained personnel.

Malfunction

 The small warning lamp flashes in yellow and then lights up continuously; the larger warning lamp comes on in yellow. On the Control Display, the wheels are shown in gray and a message appears. No punctures can be detected.

This type of message is shown in the following situations:

- ▷ If there is a malfunction
Have the system checked.
- ▷ If a wheel without TPM electronics has been mounted
- ▷ If TPM is temporarily malfunctioning due to other systems or devices using the same radio frequency.

Message for unsuccessful system reset



The warning lamp lights up yellow. A message appears on the Control Display. The system is not reset after a tire has been changed, for example.

Check the tire inflation pressure and reset the system, refer to page 93.

Declaration according to NHTSA/ FMVSS 138

Tire Pressure Monitoring Systems

Each tire should be checked monthly when cold and inflated to the inflation pressure recommended by the vehicle manufacturer on the vehicle placard or tire inflation pressure label. If your vehicle has tires of a different size than the size indicated on the vehicle placard or tire inflation pressure label, you should determine the proper tire inflation pressure for those tires. As an added safety feature, your vehicle has been equipped with a tire pressure monitoring system, TPMS, that illuminates a low tire pressure telltale when one or more of your tires are significantly under-inflated. Accordingly, when the low tire pressure telltale illuminates, you should stop and check your tires as soon as possible, and inflate them to the proper pressure. Driving on a significantly underinflated tire causes the tire to overheat and can lead to tire failure. Underinflation also reduces fuel efficiency and tire tread life, and may affect the vehicle's handling and stopping ability. Please note that the TPMS is not a substitute for proper tire maintenance, and it is the driver's responsibility to maintain correct tire pressure, even if underinflation has not reached the level at which the TPMS low tire pressure telltale illuminates.

The TPMS malfunction indicator is combined with the low tire pressure telltale. When the system detects a malfunction, the telltale will flash for approximately one minute and then remain continuously lit. This sequence will continue upon subsequent vehicle startups as long as the malfunction exists. When the malfunction indicator is illuminated, the system may not be able to detect or signal low tire pressure as intended. TPMS malfunctions may occur for a

variety of reasons, including the installation of replacement or alternate tires or wheels on the vehicle that prevent the TPMS from functioning properly. Always check the TPMS malfunction telltale after replacing one or more tires or wheels on your vehicle to ensure that the replacement or alternate tires and wheels allow the TPMS to continue to function properly.

Servotronic

The concept

"Servotronic" varies the steering force required to turn the wheels depending on the speed at which you are driving.

At low speeds, steering is assisted strongly, i.e. less effort is required to turn the vehicle. Steering assistance lessens with increasing speed.

You can select between two programs*.

"Normal" program

Select the "Normal" program if you want comfort-oriented steering, e.g. in city traffic or when parking.

"Sport" program

Select the "Sport" program if you want consistently sporty steering.

Selecting a program

 You can set and call up your preferred program via MDrive, refer to page 54.

Brake Force Display



On the left: normal braking.

On the right: sharp braking.

Airbags



The following airbags are located under the marked covers:

- 1 Front airbags
- 2 Coupe: head airbags
- 3 Side airbags in the seat backrests

Protective action

 Observe the adjustment instructions on page 45 to ensure the best possible personal protection. ◀

The front airbags help protect the driver and front passenger by responding to frontal impacts in which safety belts alone cannot provide adequate restraint. When needed, the

head and side airbags help provide protection in the event of side impact. The relevant side airbag supports the side upper body area. The head air bag supports the head.

The airbags have been designed to not be triggered in every collision situation, e.g. not in minor accidents or rear-end collisions.

⚠ Do not apply adhesive materials to the cover panels of the airbags, cover them or modify them in any other way. Do not attach seat covers, cushions or other objects not specifically approved for seats with integral side airbags to the front seats. Do not hang items of clothing such as coats or jackets over the backrests. Do not attempt to remove the airbag retention system from the vehicle. Do not modify the individual components of the system or its wiring in any way. This includes the upholstered covers on the steering wheel, instrument panel, seats and roof posts, as well as the sides of the roof lining. Do not attempt to remove or dismantle the steering wheel.

Do not touch the individual components immediately after the system has been triggered, because there is a danger of burns.

In the event of malfunctions, deactivation or triggering of the airbag restraint system, have the testing, repair, removal and disposal of airbag generators executed only by a BMW center or a workshop that works according to repair procedures of BMW with correspondingly trained personnel and that has the required explosives licenses. Unprofessional attempts to work on the system could lead to failure in an emergency or to undesired airbag activation, either of which could result in personal injury. ◀

Warning notices and information about the airbags can also be found on the sun visors.

Automatic deactivation of the front passenger airbags

An analysis of the impression in the front passenger seat cushion determines whether and how the seat is occupied. The front and side airbags for the front passenger are activated or deactivated by the system accordingly.

▶ The indicator lamp above the interior rearview mirror shows the current status of the front passenger airbags, deactivated or activated, refer to Status of front passenger airbags below. ◀

⚠ Before transporting a child on the front passenger seat, read the safety precautions and handling instructions under Transporting children safely, refer to page 57.

The front and side airbags can also be deactivated by adolescents and adults sitting in certain positions; the indicator lamp for the front passenger airbags comes on. In such cases, the passenger should change his or her sitting position so that the front passenger airbags are activated and the indicator lamp goes out. If the desired airbag status cannot be achieved by changing the sitting position, transport the relevant passenger on a rear seat. Do not attach seat covers, seat cushion padding, ball mats or other items to the front passenger seat unless they are specifically recommended by BMW. Do not place any items under the seat which could press against the seat from below. Otherwise a correct analysis of the seat cushion is not ensured. ◀

Status of front passenger airbags



The indicator lamp for the front passenger airbags shows the functional status of the front passenger's front and side airbags in accordance with whether and how the front passenger seat is occupied. The indicator lamp shows whether the front passenger airbags are activated or deactivated.

▶ The indicator lamp lights up when a child in a specially designated child-restraint system is detected, as intended, on the seat.

The front and side airbags for the front passenger are not activated.

 Most child seats are detected by the system, especially child seats required by the NHTSA at the time of vehicle production. After mounting a child seat, ensure that the indicator lamp for the front passenger airbag is lit. It indicates that the child seat has been detected and that the front passenger airbags are deactivated. ◀

- ▶ The indicator lamp does not come on as long as a person of sufficient size and in a correct sitting position is detected on the seat.
The front and side airbags for the front passenger are activated.
- ▶ The indicator lamp does not come on if the seat is empty.
The front and side airbags for the front passenger are not activated.

Operational readiness of airbag system



As of radio readiness, refer to page 59, the warning lamp comes on briefly to indicate that the entire airbag system and the belt tensioners are operational.

Airbag system malfunction

- ▶ Warning lamp does not light up at radio readiness or beyond.
- ▶ Warning lamp remains permanently on.

 In the event of a fault in the airbag system, have it checked without delay, otherwise there is the risk that the system will not function as intended even if a sufficiently severe accident occurs. ◀

Convertible: rollover protection system

The rollover protection system is activated automatically in the event of an accident, a critical driving situation, an extreme tilt in the car's longitudinal axis or upon loss of ground contact. The protection bars behind the rear head restraints deploy within fractions of a second.

As a supplementary system to the reinforced windshield frame, the rollover protection system ensures that the necessary headroom is maintained for all vehicle occupants.

 Always keep the area of movement of the rollover protection system clear. In minor accidents, you are protected by the fastened safety belt and, depending on accident severity, by the safety belt tensioner and multi-phase airbag retention system. ◀

Resetting

If the rollover protection system was not impacted after being automatically activated, it can be reset by lowering the protection bars to their original positions. This does not require tools.

1. Push the locking lever to one side and hold it there.

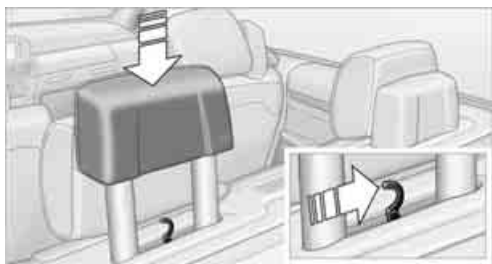

2. Push the protection bar halfway down from above.
3. Release the locking lever.

4. Push the protection bar down until it snaps into place.

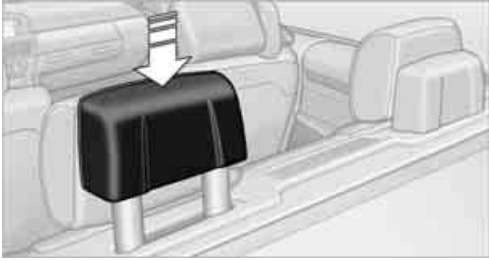

5. Repeat the procedure for the other protection bar.

Have the rollover protection system checked after an unexpected activation.

⚠ Never move the retractable hardtop when the rollover protection system is in the activated position.

Do not make any modifications to the individual components of the rollover protection system or its cabling.

Work on the rollover protection system should only be performed by a BMW center.

Incorrectly performed work on the system may lead to system failure or incorrect operation.

To check the system and ensure flawless long-term operation, always observe the service intervals, refer to page 78. ◀

Lamps

Parking lamps/low beams

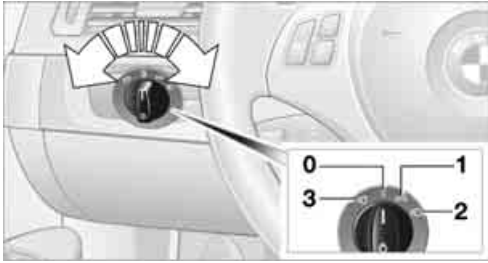

- 0 Lamps off, daytime running lamps
- 1 Parking lamps and daytime running lamps
- 2 Low-beam headlamps and welcome lamps
- 3 Automatic headlamp control*, daytime running lamps, welcome lamps and Adaptive Head Light*

When you open the driver's door with the ignition switched off, the exterior lighting is automatically switched off if the light switch is in position **0**, **2** or **3**.

Switch on the parking lamps if necessary, switch position **1**.

Parking lamps

In switch position **1**, the front, rear and side vehicle lighting is switched on. You can use the parking lamps for parking.

 The parking lamps will discharge the battery. Therefore, do not leave them on for unduly long periods of time, otherwise the battery might not have enough power to start the engine. It is preferable to switch on the left-hand or right-hand roadside parking lamps, refer to page [101](#).

Low beams

The low beams light up when the light switch is in position **2** and the ignition is on.

Automatic headlamp control*

When the switch is in position **3**, the low beams are switched on and off automatically depending on ambient light conditions, e.g. in a tunnel, in twilight, or if there is precipitation. The Adaptive Head Light* is active. The LED next to the symbol is illuminated when the low beams are on. You can also activate the daytime running lamps, refer to page [100](#). In the situations described above, the lamps then automatically switch from daytime running lamps to low beams.

The headlamps may also come on when the sun is sitting low on a blue sky.

 The automatic headlamp control cannot serve as a substitute for your personal judgment in determining when the lamps should be switched on in response to ambient lighting conditions. For example, the system cannot detect fog or hazy weather. To avoid safety risks, you should always switch on the low-beam headlamps manually under these conditions.

Welcome lamps

If you leave the light switch in position **2** or **3** when you park the car, the parking lamps and the interior lamps light up briefly when you unlock the vehicle.

Activating/deactivating welcome lamps

iDrive, for operating principle refer to page [16](#).

1. Press the **MENU** button.
This opens the start menu.
2. Press the controller to open the **i** menu.
3. Select "Settings" and press the controller.
4. Select "Vehicle / Tires" and press the controller.
5. If necessary, move the highlight marker to the uppermost field. Turn the controller

until "Lighting" is selected and press the controller.



6. Select "Welcome light" and press the controller.

The welcome lamps are switched on.

The setting is stored for the remote control currently in use.

Pathway lighting

If you activate the headlamp flasher after parking the car, with the lamps switched off, the low beams and the rear lamps come on and remain on for a certain time.

You can adjust the operating period or deactivate the function.

iDrive, for operating principle refer to page 16.

1. Press the **MENU** button.
This opens the start menu.
2. Press the controller to open the **i** menu.
3. Select "Settings" and press the controller.
4. Select "Vehicle / Tires" and press the controller.
5. Select "Lighting" and press the controller.



6. Select "Pathway lighting" and press the controller.

7. Turn the controller to select the corresponding duration.

8. Press the controller to apply the setting.

The setting is stored for the remote control currently in use.

Daytime running lamps

The daytime running lamps light up in switch position **0**, **1** and **3**. They are less powerful than the low beams.

Activating/deactivating daytime running lamps

iDrive, for operating principle refer to page 16.

1. Press the **MENU** button.
This opens the start menu.
2. Press the controller to open the **i** menu.
3. Select "Settings" and press the controller.
4. Select "Vehicle / Tires" and press the controller.
5. Select "Lighting" and press the controller.



6. Select "Daytime running lamps" and press the controller.

The daytime running lamps are switched on.

The setting is stored for the remote control currently in use.

Adaptive Head Light*

The concept

Adaptive Head Light is a variable headlamp control system that enables better illumination of the road surface. Depending on the steering

angle and other parameters, the light from the headlamp follows the course of the road.

In tight curves at speeds up to 40 mph/70 km/h, e.g. on mountainous roads or when turning, an additional, corner-illuminating lamp is switched on that lights up the inside area of the curve.

Activating Adaptive Head Light

With the ignition switched on, turn the light switch to position **3**, refer to page 99.

The corner-illuminating lamp is switched on automatically, depending on the steering wheel angle or turn signal indicator.

To avoid blinding oncoming traffic, the Adaptive Head Light directs light towards the front passenger side when the vehicle is at a standstill.

When you are reversing, only the corner-illuminating lamps are active and switched on on both sides.

Malfunction

The LED next to the symbol for automatic headlamp control flashes. Adaptive Head Light is malfunctioning or has failed. Have the system checked as soon as possible.

High beams/roadside parking lamps



- 1 High beams
- 2 Headlamp flasher
- 3 Roadside parking lamps*

Roadside parking lamps, left or right

There is an additional option of switching on the lamps on the side of the car facing the road when parked.

Switching on

After parking the vehicle, press the lever up or down beyond the pressure point for a longer period, arrow **3**.

 The roadside parking lamps drain the battery. Therefore, do not leave them on for unduly long periods of time, otherwise the battery might not have enough power to start the engine. ◀

Switching off

Press the lever in the opposite direction to the pressure point, arrow **3**.

Instrument lighting

You can adjust the brightness of the instrument lighting only when the parking lamps or the low beams are switched on.



1. Push button **1** in the turn indicator lever up or down repeatedly until the appropriate symbol appears in the display, accompanied by the brightness level and the word "SET".
2. Press button **2**.



3. Push button 1 up or down to select the desired brightness level.
4. Press button 2.
The display again shows the outside temperature and the time.

Reading lamps



There are reading lamps at the front and rear*, next to the interior lamps. To switch on and off, press the button.

Interior lamps

The interior lamps, footwell lamps*, entry lamps*, cargo bay lamp and courtesy lamps* are controlled automatically.

The LEDs for the courtesy lamps are set in the door handles and illuminate the ground in front of the doors.

 To avoid draining the battery, all lamps inside the car are switched off about 8 minutes after the ignition is switched off, refer to Start/stop button on page 59. ◀

Switching interior lamps on/off manually



Interior lamps, front and rear*:
To switch on and off, press the button.

To switch off the interior lamps, footwell lamps*, entry lamps* and courtesy lamps* permanently, press the button for the front interior lamps for about 3 seconds.

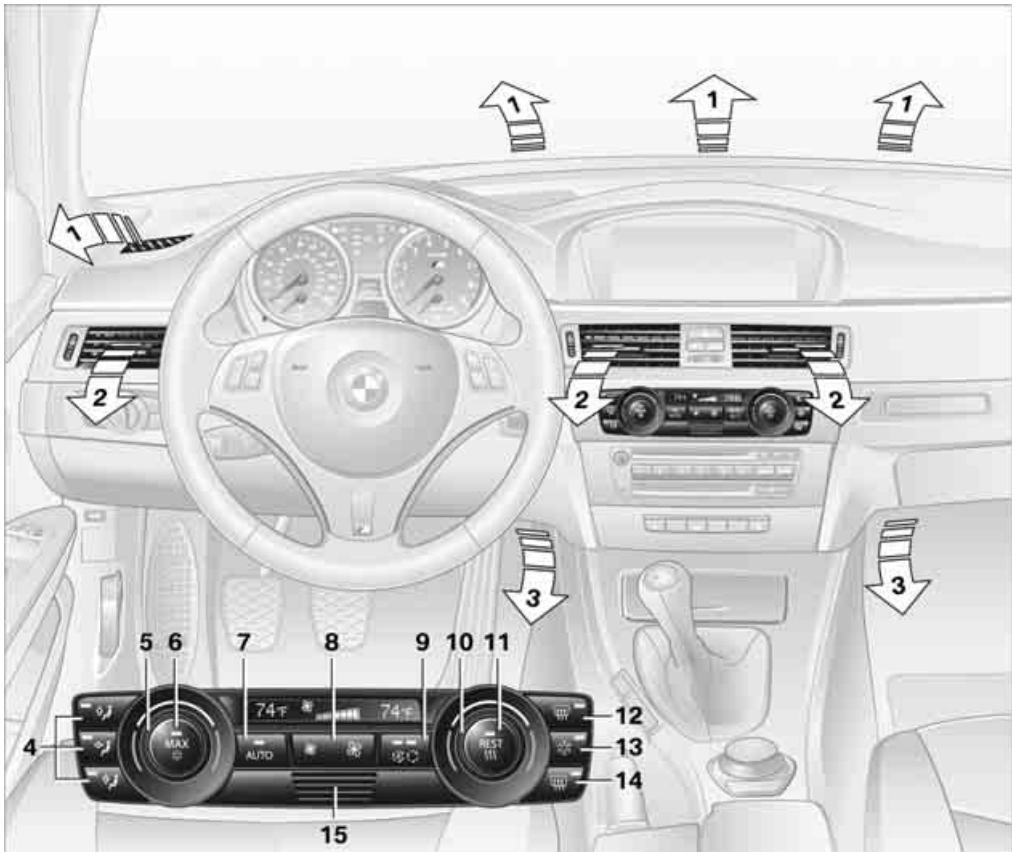

- 1 Airflow directed toward the windshield and side windows
- 2 Air to the upper body area
Draft-free ventilation [106](#)
- 3 Air to the footwell
- 4 Air distribution, manual
- 5 Temperature adjustment, left-hand side of passenger compartment
- 6 Maximum cooling
- 7 AUTO program
- 8 Air flow rate, manual
- 9 Automatic recirculated-air control AUC/ Recirculated-air mode

- 10 Temperature adjustment, right-hand side of passenger compartment
- 11 Residual heat
- 12 Defrosting windows and removing condensation
- 13 Switching cooling function on/off manually
- 14 Rear window defroster
- 15 Air grill for interior temperature sensor – please keep clear and unobstructed

The current setting for the air distribution is displayed on the Control Display, refer to page [104](#).

Automatic climate control

Comfortable interior climate

AUTO program 7 offers the ideal air distribution and air flow rate for almost all conditions, refer to AUTO program below. All you need to do is select an interior temperature which is comfortable for you.

The following sections inform you in detail about how to adjust the settings.

Most settings are stored for the remote control currently in use, refer also to Personal Profile settings on page 28.

Adjusting air distribution manually



The air distribution can be switched on and off manually. The air is directed to the windshield, to the upper body area and to the footwell. Automatic air distribution adjustment is deactivated.

You can switch the automatic air distribution back on by pressing the AUTO button. This automatically switches on the cooling function as well.

Fine adjustments to manual air distribution

You can set the rate of incoming airflow for manual air distribution.

iDrive, for operating principle refer to page 16.

1. Press the **MENU** button. This opens the start menu.
2. Move the controller to the left to open "Climate".

3. Select "Vent settings" and press the controller.

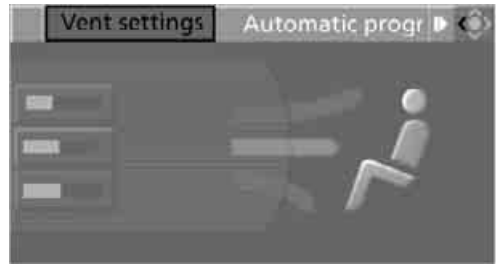

4. Select the desired field.
5. Turn the controller to set the air distribution.

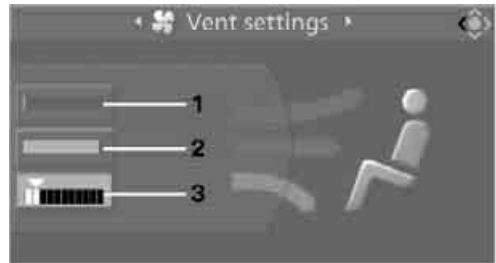

- 1 Airflow directed toward the windshield and side windows
- 2 Air to the upper body area
- 3 Air to the footwell

Temperature



Set the desired temperatures individually for the driver's and front passenger's sides.

The automatic climate control achieves this temperature as quickly as possible regardless of the season, using maximum cooling or heating power if necessary, and then maintains it.

▶ When you switch between different temperature settings in quick succession, the automatic climate control does not have enough time to achieve the set temperature. ◀

You can achieve maximum heating power with the highest setting, regardless of the outside temperature.

The lowest setting effects continuous cooling.

Maximum cooling



At outside temperatures above 32 °F / 0 °C and when the engine is running, you obtain a maximum cooling effect as soon as possible.

The automatic climate control goes into recirculated-air mode at the lowest temperature. Air flows at maximum rate from the vents for the upper body area. You should therefore open them for maximum cooling.

AUTO program



The AUTO program adjusts the air distribution to the windshield and side windows, towards the upper body area and into the footwell for you. The air flow rate and your temperature specifications will be adapted to outside influences as a result of seasonal changes, e.g. sunlight or window condensation.

The cooling is switched on automatically with the AUTO program.

Intensity of the AUTO program

Press the AUTO button repeatedly to set the intensity of the AUTO program. The current setting is briefly displayed on the Control Display every time the button is pressed.

You can also set the intensity of the AUTO program via iDrive.

1. Press the **MENU** button.
This opens the start menu.
2. Move the controller to the left to call up "Climate".
3. Select "Automatic programs" and press the controller.

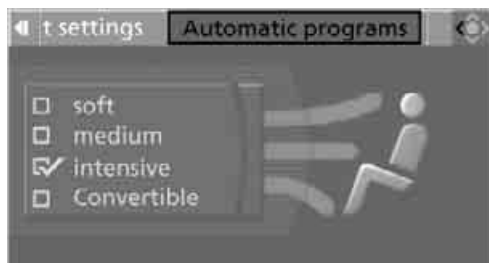

4. Select the desired intensity and press the controller.

 The selected intensity level of the automatic program is switched on.

Convertible program

When the hardtop is open, the Convertible program is selectable as well. In the Convertible program, the automatic climate control is optimized for driving with the hardtop open. In addition, the air flow rate is increased as vehicle speed increases.

When the Convertible program has been selected, it is automatically activated every time the hardtop is opened.

 The effectiveness of the Convertible program can be enhanced considerably by installing the wind deflector. ◀

Adjusting air flow rate manually



Press the left side of the button to reduce airflow. Press the right side of the button to increase it.

You can reactivate the automatic mode for the air flow rate with the AUTO button.

The air flow rate may be reduced or the blower may be switched off entirely to save on battery power. The display remains the same.

Switching the system on/off

With the blower at its lowest setting, press the left side of the button to switch off the automatic climate control. All displays are cleared except for the rear window defroster if it is switched on.

Press any button except REST or rear window defroster to reactivate the automatic climate control.

Automatic recirculated-air control AUC/Recirculated-air mode



Switch on the desired operating mode by pressing this button repeatedly:

- ▷ LED off: outside air flows in continuously.

- ▷ Left-hand LED on, AUC mode: a sensor detects pollutants in the outside air. If necessary, the system blocks the supply of outside air and recirculates the inside air. As soon as the concentration of pollutants in the outside air has decreased sufficiently, the system automatically switches back to outside air supply.
- ▷ Right-hand LED on, recirculated-air mode: the supply of outside air is permanently shut off. The system then recirculates the air currently within the vehicle.

 If condensation starts to form on the inside window surfaces during operation in the recirculated-air mode, you should switch it off while also increasing the air flow rate as required.

The recirculated-air mode should not be used continuously for lengthy periods, otherwise the quality of the air inside the car will gradually deteriorate. ◀

Via the button on the steering wheel

You can switch quickly between the recirculated-air mode and the previous mode using an individually programmable button on the steering wheel, refer to page 53.

Residual heat



The heat stored in the engine is used to heat the passenger compartment, e.g. while stopped at a school to pick up a child.

The function can be switched on when the following conditions are met:

- ▷ Up to 15 minutes after the engine has been switched off
- ▷ While the engine is at operating temperature
- ▷ As long as battery voltage is sufficient
- ▷ At an outside temperature below 77 °F / 25 °C

The LED is lit when the function is on.

As of radio readiness, you can set the interior temperature, the air flow rate and the air distribution.

Defrosting windows and removing condensation



Quickly removes ice and condensation from the windshield and front side windows.

Switch on the cooling function as well.

Switching cooling function on/off



The cooling function cools and dehumidifies the incoming air before reheating it as required, according to the temperature setting. This function is only available while the engine is running.

The cooling function helps prevent condensation on the windows or removes it quickly.

Depending on the weather, the windshield may fog over briefly when the engine is started.

The cooling function is automatically switched on along with the AUTO program.

Rear window defroster



The defroster is switched off automatically after a certain time.

Depending on your vehicle's equipment, the upper wires serve as an antenna and are not part of the rear window defroster.

Ventilation

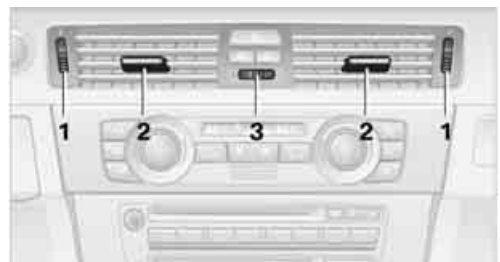

- 1 Use the knurled wheels to smoothly open and close the air vents
- 2 Use the lever to change the direction of the airflow
- 3 Knurled wheel for more or less cool air from the vents for the upper body area

Ventilation for cooling

Adjust the vent outlets to direct the flow of cool air in your direction, for instance if it has become too hot in the car.

Draft-free ventilation

Set the vent outlets so that the air flows past you and not straight at you.

Ventilation in the rear

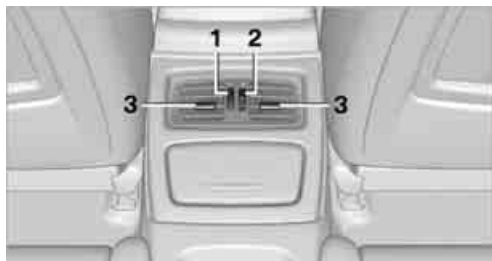

- Use the knurled wheel to adjust the temperature
 - ▷ Turn toward blue: colder
 - ▷ Turn toward red: warmer
- Use the knurled wheel to smoothly open and close the air vents
- Use the lever to change the direction of the airflow

Microfilter/activated-charcoal filter

The microfilter traps dust and pollen in the incoming air. The activated-charcoal filter provides additional protection by filtering gaseous pollutants from the outside air. Your BMW center replaces this combined filter during routine maintenance.

Parked car ventilation

The concept

The parked car ventilation provides ventilation to the passenger compartment and lowers its temperature, if necessary.

It is ready for use at any outside temperature during parked car operation.

The parked car ventilation remains switched on for 30 minutes. Two different switch-on times can be preselected. The system can also be switched on and off directly.

Due to its high power consumption, it should not be switched on twice in a row without driving in between to allow the battery to recharge.

The air emerges from the air vents for the upper body area in the instrument panel. The air vents must therefore be open.

The parked car ventilation system is operated via iDrive.

Switching on/off directly

iDrive, for operating principle refer to page 16.

- Press the **MENU** button. This opens the start menu.
- Move the controller to the left to open "Climate".
- Select "Parked car operation" and press the controller.
- Select "Automatic ventilation" and press the controller.
- Select "Parked car ventilation" and press the controller.

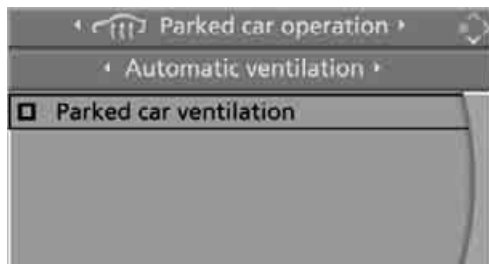

- The parked car ventilation is switched on.
- The symbol on the automatic climate control display flashes.

Preselecting switch-on times

iDrive, for operating principle refer to page 16.

- Press the **MENU** button. This opens the start menu.
- Move the controller to the left to open "Climate".

3. Select "Parked car operation" and press the controller.
4. Select "Activation time" and press the controller.
5. Move the controller to the left or right to select "Timer 1" or "Timer 2".



6. Select the time and press the controller. The first time setting is selected.

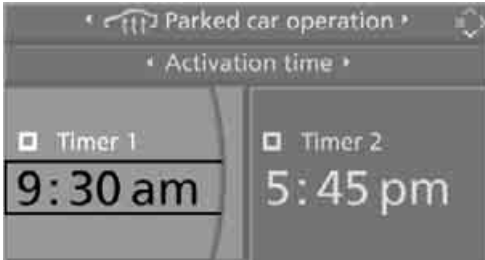



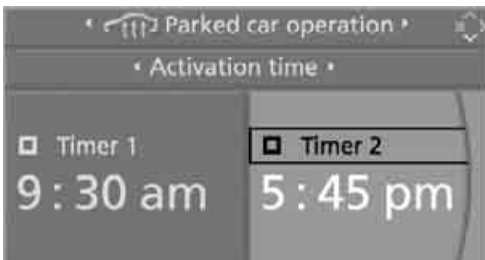

7. Turn the controller to make the adjustment.
8. Press the controller to apply the setting. The next setting is highlighted.
9. Make the remaining adjustments. After the last adjustment, the time is stored.

Activating switch-on times

Move the controller to the left or right to select "Timer 1" or "Timer 2" and then press the controller.



-  The switch-on time is activated.
-  The symbol on the automatic climate control display lights up.
-  The symbol on the automatic climate control display flashes when the system has switched on.
-  The parked car ventilation is switched on within the next 24 hours only. After these have elapsed, it must be reactivated. ◀

Practical interior accessories

Integrated universal remote control*

The concept

The integrated universal remote control can replace as many as three hand-held transmitters for various remote-controlled devices, such as garage doors and gates or lighting systems. The integrated universal remote control registers and stores signals from the original hand-held transmitters.

The signal of an original hand-held transmitter can be programmed on one of the three memory buttons **1**. After this, the programmed memory button **1** will operate the system in question. The LED **2** flashes to confirm transmission of the signal.

Should you sell your vehicle one day, be sure to delete the stored programs beforehand for your safety, refer to page **110**.

 To prevent possible damage or injury, before programming or using the integrated universal remote control, always inspect the immediate area to make certain that no people, animals or objects are within the pivoting or travel range of the device being operated. Comply also with the safety instructions supplied with the original hand-held transmitter. ◀

Checking compatibility

 If this symbol appears on the package or in the instructions supplied with the original hand-held transmitter, you can assume that the radio remote control device will be compatible with the integrated universal remote control.

For additional information, please contact your BMW center or call: 1-800-355-3515.

You can also obtain information on the Internet at:

www.bmwusa.com or
www.homelink.com.

HomeLink is a registered trademark of Johnson Controls, Inc. ◀

Programming



- 1 Memory buttons
- 2 LED

Fixed-code hand-held transmitters

1. Switch on the ignition, refer to page **59**.
2. When starting operation for the first time: Press the left and right memory buttons **1** for approx. 20 seconds until the LED **2** flashes rapidly. The three memory buttons are cleared.
3. Hold the original hand-held transmitter at a distance of approx. 4 to 12 in/10 to 30 cm from the memory buttons **1**.

 The required distance between the hand-held transmitter and the memory buttons **1** depends on the system of the respective original hand-held transmitter used. ◀

4. Simultaneously press the transmit key on the original hand-held transmitter and the desired memory button **1** on the integrated universal remote control. The LED **2** flashes slowly at first. As soon as the LED **2** flashes rapidly, release both buttons. If the LED **2** does not flash rapidly after approx. 15 seconds, alter the distance and repeat this step.
5. To program other original hand-held transmitters, repeat steps 3 and 4.

The corresponding memory button **1** is now programmed with the signal of the original hand-held transmitter.

You can operate the device while the ignition is switched off.

 If the device fails to function even after repeated programming, check whether the original hand-held transmitter uses an alternating-code system. To do so, either read the instructions for the original hand-held transmitter or hold down the programmed memory button **1** of the integrated universal remote control. If the LED **2** on the integrated universal remote control flashes rapidly and then remains lit for about two seconds, the original hand-held transmitter uses an alternating-code system. If it uses an alternating-code system, program the memory buttons **1** as described under Alternating-code hand-held transmitters. ◀

Alternating-code hand-held transmitters

To program the integrated universal remote control, consult the operating instructions for the device to be set. You will find information there on the possibilities for synchronization. When programming hand-held transmitters that employ an alternating code, please observe the following supplementary instructions:

 Programming will be easier with the aid of a second person. ◀

1. Park your vehicle within the range of the remote-controlled device.
2. Program the integrated universal remote control as described above in the section Fixed-code hand-held transmitters.
3. Locate the button on the receiver of the device to be set, e.g. on the drive unit.
4. Press the button on the receiver of the device to be set. After step 4, you have approx. 30 seconds for step 5.
5. Press the programmed memory button **1** of the integrated universal remote control three times.

The corresponding memory button **1** is now programmed with the signal of the original hand-held transmitter.

 If you have any questions, please contact your BMW center. ◀

Deleting all stored programs

Press the left and right memory buttons **1** for approx. 20 seconds until the LED **2** flashes rapidly: all stored programs are deleted.

Reassigning individual programs

1. Hold the original hand-held transmitter at a distance of approx. 4 to 12 in/10 to 30 cm from the memory buttons **1**.

 The required distance between the hand-held transmitter and the memory buttons **1** depends on the system of the respective original hand-held transmitter used. ◀

2. Press the desired memory button **1** of the integrated universal remote control.
3. If the LED **2** flashes slowly after approx. 20 seconds, press the transmit key of the original hand-held transmitter. Release both buttons as soon as the LED **2** flashes rapidly. If the LED **2** does not flash rapidly after approx. 15 seconds, alter the distance and repeat this step.

Digital compass*

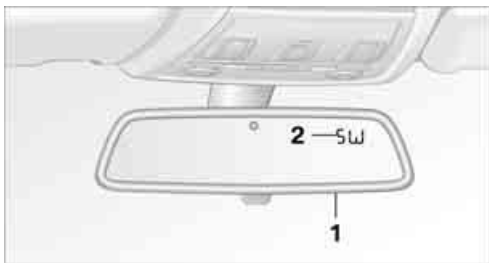

- 1 Adjustment button
- 2 Display

The display shows you the main or secondary compass direction in which you are driving.

Operating principle

You can call up various functions by pressing the adjustment button with a pointed object

such as a pen or similar item. The following adjustment options are displayed one after the other, depending on how long you keep the adjustment button pressed:

- ▷ Press briefly: switch display on/off
- ▷ 3 to 6 seconds: set the compass zone
- ▷ 6 to 9 seconds: calibrate the compass
- ▷ 9 to 12 seconds: set left-hand/right-hand steering
- ▷ 12 to 15 seconds: set the language

Setting compass zones

Set the compass zone corresponding to your vehicle's geographic location so that the compass can function correctly; refer to the world map with compass zones.

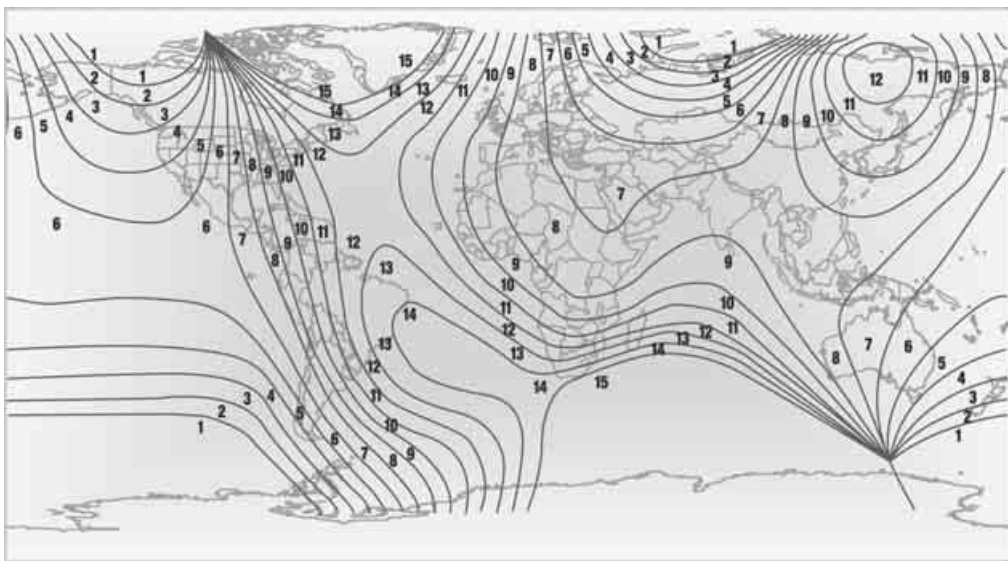

To set the compass zone, press the adjustment button for approx. 3-4 seconds. The number of the compass zone set is shown in the display.

To change the zone setting, briefly press the adjustment button repeatedly until the display shows the number of the compass zone corresponding to your current location.

The compass is operational again after approx. 10 seconds.

Calibrating the digital compass

The digital compass must be calibrated in the following situations:

- ▷ An incorrect compass direction is shown.

- ▷ The compass direction shown does not change although the direction of travel does.
- ▷ Not all compass directions are shown.

Procedure

1. Make sure that no large metal objects or overhead power lines are in the vicinity of your vehicle and that you have enough space to drive in a circle.
2. Set the currently valid compass zone.
3. Press the adjustment button for approx. 6-7 seconds to call up C. Then drive in at least one full circle at a speed of no more than 4 mph or 7 km/h.
If calibration is successful, the display changes from C to a compass direction.

Setting right-hand/left-hand steering

Your digital compass is factory-set to right-hand or left-hand steering, in accordance with your vehicle.

Setting the language

You can set the language of the display:

Press the adjustment button for approx. 12-13 seconds. Briefly press the adjustment button again to switch between English, "E", and German, "O".

The setting is automatically saved after approx. 10 seconds.

Coupe: Roller sun blind*



Tap the button in the center console to raise or lower the roller sun blind.

Glove compartment

Opening

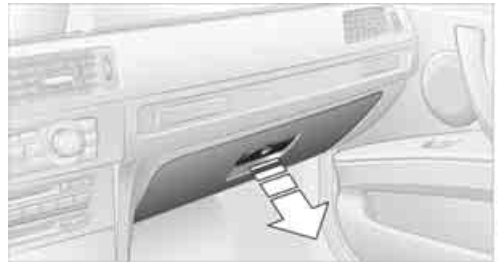

Pull the handle.

The light in the glove compartment comes on.

 To prevent injury in the event of an accident while the vehicle is being driven, close the glove compartment immediately after use. ◀

Closing

Fold cover up.

Locking

To lock the glove compartment, use the integrated key of the remote control, refer to page 28.

Convertible: when you lock the vehicle from the outside, the glove compartment is locked as well.

LED hand lamp

In a holder on the left side of the glove compartment.



 Insert the hand lamp into the holder with the lens pointing toward the passenger compartment to ensure that the lamp cannot be switched on accidentally. ◀

Center armrest

Storage compartment

The center armrest between the front seats contains either a compartment or the cover for the snap-in adapter*, depending on the equipment version. For more information about this mobile phone base plate refer to the separate Owner's Manual.

Convertible: when you lock the vehicle from the outside, the center armrest is locked as well.

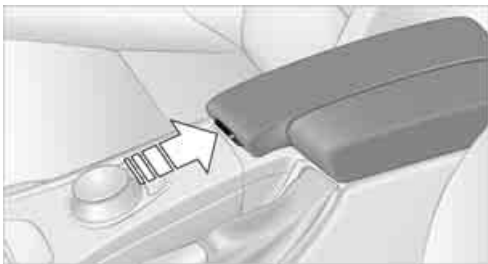

Opening

Press the button, see arrow.

Ventilated storage compartment



The storage compartment in the center armrest can be ventilated: slide the switch backwards.

The temperature is controlled via the knurled wheel for adjusting the temperature of air ventilating the rear of the passenger compartment, refer to page 107.

Connection for external audio device

You can connect an external audio device such as a CD or MP3 player and play audio tracks over the car's loudspeaker system:

- ▷ AUX-In port, refer to page 181
- ▷ USB-audio interface*, refer to page 182

Storage compartments inside the vehicle

Depending on your vehicle's equipment, you will find compartments beside the steering column*, in the front doors and in the center console*.

There are nets on the front-seat backrests.

Storage compartments in the rear console

Depending on your vehicle's equipment version, the following storage compartments can be found in the rear console:



- ▷ Storage tray
- ▷ Storage compartment with cover
- ▷ Cup holders

Coupe: clothes hooks

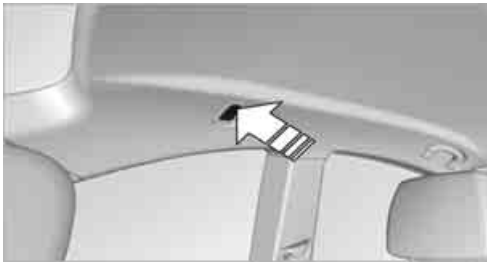

Press the upper edge to flip open.

! Items of clothing hung from the hooks must not obstruct the driver's view. Do not hang heavy objects from the hooks, otherwise they could endanger the car's occupants, e.g. in case of heavy braking or sudden swerving. ◀

Cup holders

! Use lightweight and shatterproof containers and do not transport hot beverages, otherwise there is an increased risk of injury in the event of the accident. Do not force containers that are too large into the cup holders, otherwise damage could result. ◀

Front

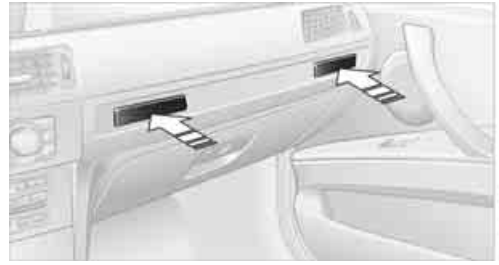

Opening

Briefly press the center of the cover.

Closing

Briefly press the cover in the center and push in the cup holder.

Rear*

There are two additional cup holders in the rear console.

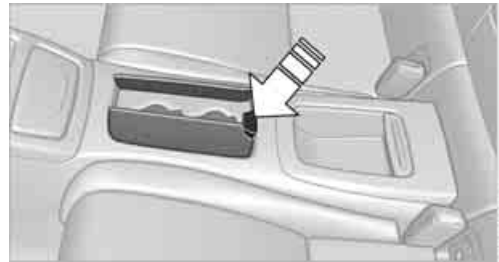

Press the button to open.

! Before folding down the rear seat backrest or using the transport bag, remove all containers from the cup holder and close it. Do not place objects into the cup holder and do not use force to close it. Do not use the cup holder as a grab handle. ◀

Ashtray, front

Opening

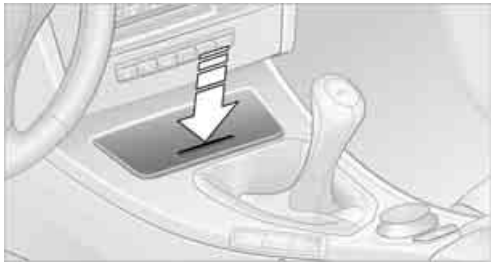

Push the ridge on the cover.

Emptying



Lift out the insert.

Lighter



With the engine running or the ignition switched on, press in the cigarette lighter.

The lighter can be pulled out as soon as it pops back out.

 Hold or touch the hot cigarette lighter by the knob only. Holding or touching it in other areas could result in burns.

When leaving the car, always remove the

remote control so that children cannot operate the cigarette lighter and burn themselves. ◀

Ashtray, rear

Opening



Push the ridge on the cover.

Emptying

Lift out the insert.

Connecting electrical appliances

In your BMW, when the engine is running or the ignition is switched on, you can use electrical devices such as a flashlight, car vacuum cleaner, etc., up to approx. 200 watts at 12 volts, as long as one of the following sockets is available. Avoid damaging the sockets by attempting to insert plugs of unsuitable shape or size.

Cigarette lighter socket*

To access the socket: take the cigarette lighter out of the socket.

Socket in the center armrest

External audio device, refer to page 113.

Coupe: socket in the cargo bay*



Open the cap.

Coupe: Through-loading system

Opening

1. To release the rear seat backrest, pull the corresponding lever in the cargo bay.

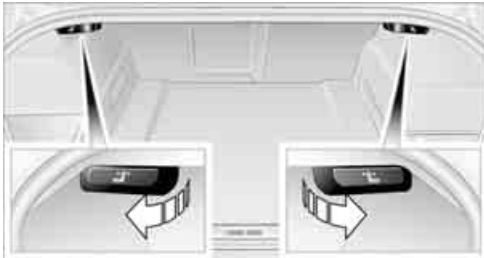

2. The unlocked rear seat backrest moves forward slightly. Fold the backrest forward by the head restraint.



Closing

Return the rear seat backrest to its upright position and engage it.

 When returning the backrest into its seating position, make sure that the seat's locking mechanism engages properly. Otherwise, cargo could be thrown around in the event of sharp braking or swerving and endanger the occupants. ◀

The lashing eyes in the cargo bay provide you with a way to attach cargo bay nets* or draw straps for securing suitcases and luggage, refer to page 127.

Convertible: Cargo loading

Enlarging the cargo bay



When the hardtop is closed you can enlarge the cargo bay:

To do so, push the cargo bay partition upward. Before opening the hardtop, push the cargo bay partition down until it engages on both sides.

 Before moving the hardtop, ensure that there are no objects on or next to the cargo bay partition, otherwise parts of the hardtop may be damaged. Do not exceed the maximum loading height; refer to the sticker in the cargo bay showing a line indicating the maximum height. Do not use force to push down the cargo bay partition. ◀

 The retractable hardtop can only be opened if the cargo bay partition is in its lowest position and engaged on both sides. ◀

Folding down the rear seat backrest

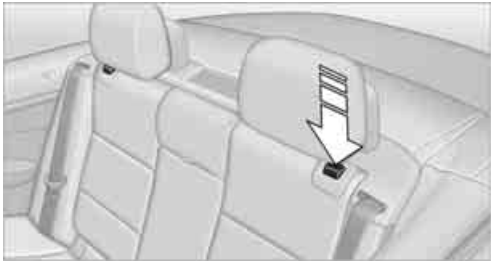

You can fold down the rear seat backrest to transport light objects in the rear without damaging the seats. Depending on the vehicle equipment, the mounting points for the cargo bay net* are found on the back of the seat backrest. To unlock the rear seat backrest: press the button on the driver's or the opposite side.

Bag holder*

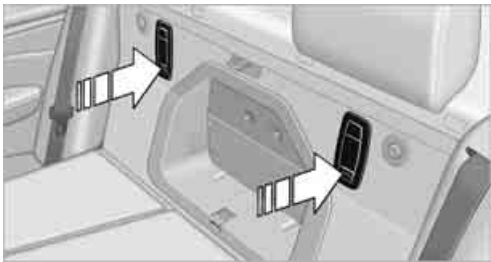

When the rear seat backrest is folded down, you will find two bag holders on the cargo bay wall:

1. Fold open the holder by pressing the button.
2. Press the handles of the bag onto the holder from above.

! Only hang light shopping bags or other suitable objects from the holders, otherwise braking maneuvers and swerving may lead to a safety hazard due to objects flying about the passenger compartment. Only transport heavy luggage in the cargo bay if it has been appropriately secured. ◀

For more information on loading the vehicle, refer to page 126.

Storage compartment behind the rear seat backrest

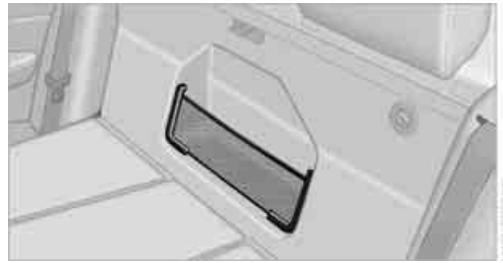

A storage compartment is located behind the rear seat backrest. To access the storage compartment: remove the insert or fold down the rear seat backrest.

! When the rear seat backrest is folded down or the insert has been removed, only transport small light objects in the storage compartment, otherwise braking maneuvers and swerving may lead to a safety hazard due to objects flying about the passenger compartment. Only transport heavy luggage in the cargo bay if it has been appropriately secured. ◀

Storage compartments inside the cargo bay

Coupe

Depending on your vehicle's equipment, the following storage spaces can be found in the cargo bay:

- ▷ Left storage compartment, e.g. for storing a box of cleaning tissues or up to 12 CD jackets, depending on vehicle equipment version
- ▷ Net* for securing smaller objects, to be attached to the fixtures on the floor panel
- ▷ Hooks for hanging up, e.g., shopping bags or tote bags
- ▷ Rubber strap on the left trim panel for securing small objects such as a folding umbrella
- ▷ Net for small objects on the right trim panel of the cargo bay

Convertible

Depending on your vehicle's equipment, the following storage spaces can be found in the cargo bay:

- ▷ Storage compartment on the left side of the cargo bay. To open turn handle by 90°
- ▷ Net* for securing smaller objects, to be attached to the fixtures on the floor panel
- ▷ Rubber band* to be attached to the lateral lashing eyes
- ▷ Stowage compartment under the floor panel

Folding up the floor panel

 Do not exceed the maximum permissible load of 55 lbs/25 kg for the storage compartment under the floor panel, otherwise damage could result. ◀

Coupe

Press the floor panel up and secure it with the catch.

Convertible

To lift, grab hold of the floor panel at the opening at the rear of the panel.

Lashing eyes

You will find lashing eyelets in the cargo bay for securing luggage items with nets or tensioning straps, refer to page 127.

Coupe: ski bag*

The ski bag is designed for safe, clean transport of up to 4 pairs of standard skis or up to 2 snowboards.

With the ski bag you can stow skis with a length of up to 6 ft 10 in/2.10 m. When skis of 6 ft 10 in/2.10 m length are loaded, the overall capacity of the ski bag is reduced due to its tapered design.

Loading

1. Take out the filler piece.
2. Press the button, reach into the recess and fold down the cover.



3. Open the Velcro fastener, spread the ski bag between the front seats and insert the skis or snowboards. The zip fastener makes objects in the ski bag easier to reach.
4. Clip the hooks of the ski bag retaining strap into the eyelet.



Only place clean skis in the ski bag. Wrap sharp edges to prevent damage.

Securing cargo



After loading, secure the ski bag and its contents. Tighten the retaining strap on the tensioning buckle for this purpose.

 Secure the ski bag in the manner described, otherwise it could endanger the car's occupants, e.g. in case of heavy braking or sudden swerving. ◀

To store the ski bag, perform the steps described for loading in reverse order.

Removing the ski bag

The ski bag can be completely removed, e.g. for faster drying or to allow you to use other inserts.

1. Fold down the center panel in the rear seat backrest.
2. Pull the handle, arrow 1.



3. Pull out the insert, arrow 2.

 For more information on the various inserts available, contact your BMW center. ◀

Convertible: through-loading opening with integrated transport bag*

The transport bag is designed for safe, clean transport of up to 4 pairs of standard skis or up to 2 snowboards.

When the rear seat backrest is folded up, you can remove the insert and use the transport bag with the regular through-loading opening. To transport larger objects, you can fold down the rear seat backrest to create an expanded through-loading opening.

With the transport bag you can stow skis with a length of up to 6 ft 2 in/1.90 m. When skis of 6 ft 2 in/1.90 m length are loaded, the overall capacity of the transport bag is reduced due to its tapered design.

Loading

1. For loading using the regular through-loading opening:
Press the button down and remove the insert from the front.
For loading with the through-loading opening expanded:
Fold down the rear seat backrest, refer to page 117.

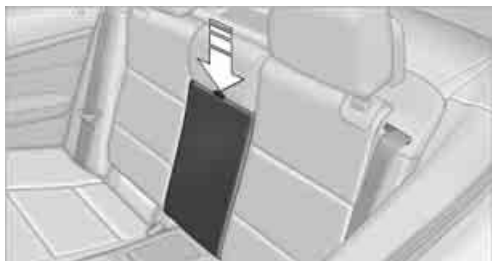

2. Front cover: press the two recesses together and fold the cover down until it engages.



3. In the cargo bay: press the two recesses together and fold down the cover.

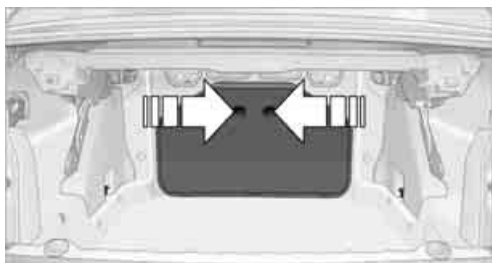

4. Undo the Velcro fastener and spread out the transport bag between the front seats.



Driving tips

This section provides you with information useful in dealing with specific driving and operating conditions.

Things to remember when driving

Break-in period

Moving parts need breaking-in time to adjust to each other. Please follow the instructions below in order to achieve the optimal service life and economy of operation for your vehicle.

Engine and differential

Always obey all official speed limits.

Up to 1,200 miles/2,000 km

Drive at varying engine and road speeds, but do not exceed an engine speed of 5,500 rpm or a road speed of 105 mph/170 km/h.

Do not depress the accelerator all the way.

From 1,200 miles/2,000 km to 3,000 miles/5,000 km

Engine and road speeds can be increased gradually up to a traveling speed of 135 mph/220 km/h. Use the maximum speed only for brief intervals, e.g. when passing.

Transmission

The transmission begins functioning at an optimal level only after a distance of approx. 300 miles/500 km. Do not exceed engine speeds of 5,500 rpm during this period.

Tires

Due to technical factors associated with their manufacture, tires do not achieve their full traction potential until after an initial break-in period. Therefore, drive cautiously during the first 200 miles/300 km.

Brake system

Brakes require an initial break-in period of approx. 300 miles/500 km to achieve optimized contact and wear patterns between brake pads and rotors. Drive cautiously during this break-in period.

Clutch

The function of the clutch reaches its optimal level only after a distance driven of approx. 300 miles/500 km. During this break-in period, engage the clutch gently.

Following part replacement

The same break-in procedures should be observed if any of the components mentioned above have to be renewed in the course of the vehicle's operating life.

General driving notes

Clearance

 Mind the limited clearance of the BMW M3, e.g. when driving into underground parking garages or over obstacles. If equipped with EDC*, select the "Sport" program, refer to page 90, when driving off curbs to keep clearance as even as possible. Otherwise the vehicle may be damaged. ◀

Close the luggage compartment lid

 Operate the vehicle only when the luggage compartment lid is closed. Otherwise, exhaust fumes could enter the interior of the vehicle. ◀

If the vehicle must be driven with the luggage compartment lid open:

1. Close all windows and the glass roof.
2. Greatly increase the air volume of the automatic climate control system, refer to page 105.

Hot exhaust system

 In all vehicles, extremely high temperatures are generated in the exhaust system. Do not remove the heat shields installed adjacent to various sections of the exhaust system, and never apply undercoating to them. When driving, standing at idle and while park-

ing, take care to avoid possible contact between the hot exhaust system and any highly flammable materials such as hay, leaves, grass, etc. Such contact could lead to a fire, with the risk of serious personal injuries and property damage. Do not touch hot exhaust pipes, e.g. when loading the cargo bay, otherwise there is a risk of burn injuries. ◀

Hydroplaning

 When driving on wet or slushy roads, reduce road speed. If you do not, a wedge of water can form between tires and road surface. This situation, known as hydroplaning, means that the tire can completely lose contact with the road surface, so that neither the car can be steered nor the brake be properly applied. ◀

The risk of hydroplaning increases with declining tread depth on the tires, refer also to Minimum tread depth on page 219.

Driving through water

 Drive through water on the road only if it is not deeper than 1 ft/30 cm, and then only at walking speed at the most. Otherwise, the vehicle's engine, the electrical systems and the transmission may be damaged. ◀

Use the parking brake on inclines

 On inclines, do not hold the vehicle for a lengthy period using the clutch; use the parking brake instead. Otherwise greater clutch wear will result. ◀

For more information about the drive-off assistant, refer to page 90.

Braking safely

Your BMW is equipped with ABS as a standard feature. Applying the brakes fully is the most effective way of braking in situations in which this is necessary. Since the vehicle maintains steering responsiveness, you can still avoid possible obstacles with a minimum of steering effort.

Pulsation of the brake pedal, combined with sounds from the hydraulic circuits, indicate that ABS is in its active mode.

Driving in wet conditions

When roads are wet or there is heavy rain, briefly exert gentle pressure on the brake pedal every few miles. Monitor traffic conditions to ensure that this maneuver does not endanger other road users. The heat generated in this process helps dry the pads and rotors to ensure that full braking efficiency will then be available when you need it.

Hills

 To prevent overheating and the resulting reduced efficiency of the brake system, drive long or steep downhill gradients in the gear in which the least braking is required. Even light but consistent brake pressure can lead to high temperatures, brake wear and possibly even brake failure. ◀

You can increase the engine's braking effect by shifting down, all the way to first gear if necessary. This strategy helps you avoid placing excessive loads on the brake system.

 M dual clutch transmission: never drive with the transmission in neutral or with the engine switched off; otherwise, engine braking action will not be present or there will be no power assistance to the brakes or steering. Manual transmission: never drive with the clutch held down, with the transmission in neutral or with the engine switched off; otherwise, engine braking action will not be present or there will be no power assistance to the brakes or steering.

Never allow floor mats, carpets or any other objects to protrude into the area around the pedals, otherwise pedal function could be impaired. ◀

Corrosion on brake rotors

When the vehicle is driven only occasionally, during extended periods when the vehicle is not used at all, and in operating conditions where brake applications are less frequent, there is an increased tendency for corrosion to form on rotors, while contaminants accumulate on the brake pads. This occurs because the minimum pressure which must be exerted by the pads

during brake applications to clean the rotors is not reached.

This can also lead to a permanent loss in ride comfort and to squealing noises during braking. A loss in comfort can also be caused by extended braking with little pressure on the pedal.

Should corrosion form on the brake rotors, the brakes will tend to respond with a pulsating effect that even extended application will fail to cure.

For information on brake system technology, refer to Compound brake on page 129.

When the vehicle is parked

Condensation forms while the automatic climate control is in operation, and then exits under the vehicle. Traces of condensed water under the vehicle are therefore normal.

Cargo loading

 To avoid loading the tires beyond their approved carrying capacity, never overload the vehicle. Overloading can lead to overheating and increases the rate at which damage develops inside the tires. This can ultimately result in a sudden blow-out. ◀

 Make sure that no liquids are spilled or leak from their containers in the cargo bay, as this could result in damage to the vehicle. ◀

Determining loading limit



1. Locate the following statement on your vehicle's placard*:
 -  The combined weight of occupants and cargo should never exceed XXX kg or YYY lbs. Otherwise, overloading can result in damage to the vehicle and unstable driving conditions. ◀
2. Determine the combined weight of the driver and passengers that will be riding in your vehicle.
3. Subtract the combined weight of the driver and passengers from XXX kilograms or YYY pounds.
4. The resulting figure equals the available amount of cargo and luggage load capacity. For example, if the YYY amount equals 1,400 lbs. and there will be five 150-lb. passengers in your vehicle, the amount of available cargo and luggage load capacity is 650 lbs:

$$1,400 \text{ lbs.} - 750 \text{ lbs.} = 650 \text{ lbs.}$$
5. Determine the combined weight of luggage and cargo being loaded on the vehicle. That weight may not safely exceed the available cargo and luggage load capacity calculated in step 4.
6. If your vehicle will be towing a trailer, part of the load from your trailer will be transferred to your vehicle. Consult the manual for transporting a trailer to determine how this may reduce the available cargo and luggage load capacity of your vehicle.

Load

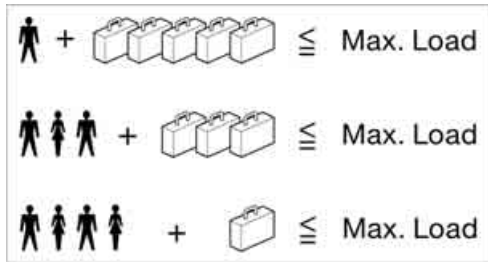

The permissible load is the total of the weight of occupants and cargo/luggage. The greater the weight of the occupants, the less cargo/luggage can be transported.

Stowing cargo

- ▶ Position heavy objects as low and as far forward as possible, ideally directly behind the respective seat backrests.
- ▶ Cover sharp edges and corners.
- ▶ For very heavy cargo when the rear seat is not occupied, secure each safety belt in the opposite buckle.

Coupe

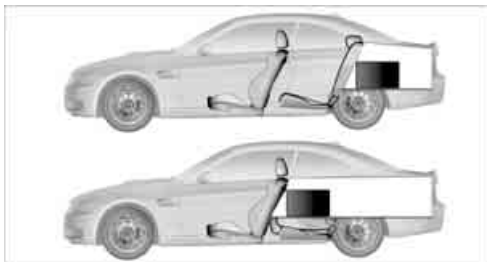

Convertible

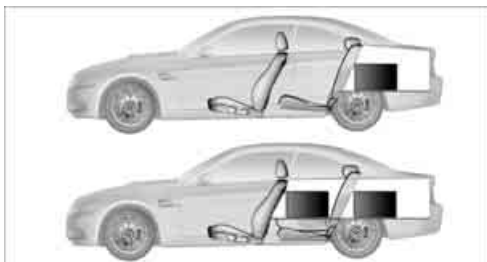

Securing cargo

Coupe

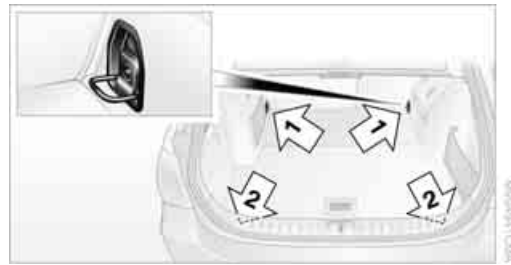

Convertible

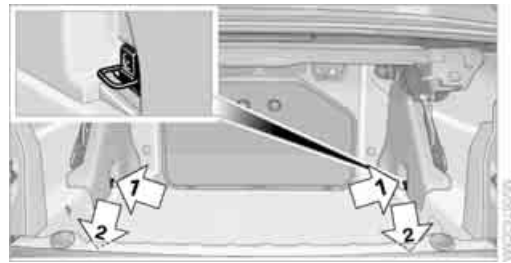

! Convertible: before opening the hardtop, fold down the cargo bay partition. Make sure the cargo bay is loaded correctly, otherwise parts of the hardtop can be damaged, refer to page 116. ◀

- ▶ Secure smaller and lighter items using retaining straps, a cargo bay net* or draw straps*.
- ▶ Heavy-duty cargo straps* for securing larger and heavier objects are available at your BMW center. Four lashing eyes are provided for attaching the cargo straps. Two are located on the cargo bay sidewalls **1**, two more are on the rear cargo bay panel **2**.

Please comply with the information supplied with the cargo straps.

! Position and secure the cargo as described above, so that it cannot endanger the car's occupants, for example if sudden braking or swerving is necessary. Never exceed either the approved gross vehicle weight or either of the approved axle loads, refer to page 251, as excessive loads can pose a

safety hazard, and may also place you in violation of traffic safety laws.

Heavy or hard objects should not be carried loose inside the car, since they could be thrown around, for example as a result of heavy braking, sudden swerves, etc., and endanger the occupants.

Only attach the cargo straps using the lashing eyes shown in the illustration. Do not secure cargo with the anchors for tether straps, refer to page 58, otherwise these could be damaged. ◀

The roof load must be distributed uniformly and should not be too large in area. Heavy items should always be placed at the bottom. Be sure that adequate clearance is maintained for raising the glass roof, and that objects do not project into the opening path of the luggage compartment lid.

Fasten roof-mounted cargo correctly and securely to prevent it from shifting or falling off during the trip.

Drive smoothly. Avoid sudden acceleration and braking maneuvers. Take corners gently.

Coupe roof-mounted luggage rack*

 A luggage rack mounted on the roof changes vehicle aerodynamics and handling. Exercise restraint when driving with a roof-mounted luggage rack to avoid the risk of an accident. ◀

A special rack system is available as an option for your BMW. Comply with the directions given in the installation instructions.

Mounting points

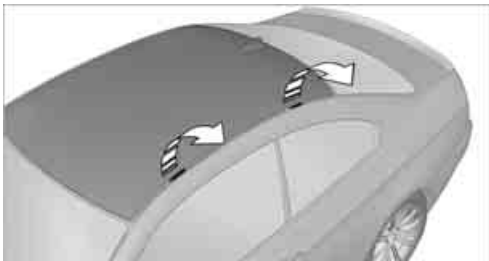

The mounting points are located in the roof.

Loading roof-mounted luggage rack

Because roof racks raise the vehicle's center of gravity when loaded, they have a major effect on vehicle handling and steering response.

You should therefore always remember not to exceed the approved roof load capacity, the approved gross vehicle weight or the axle loads when loading the rack.

You can find the applicable data under Weights on page 251.

BMW M3 engineering

High performance V8 engine



The high-revving V8 engine draws a maximum power of 420 hp/309 kW and a peak torque of 295 lb ft/400 Nm from a displacement of 244 cu in/4 liters. Its spontaneous response results in a very wide effective rpm range. The maximum engine speed lies at 8,400 rpm and is electronically controlled. Due to the high engine dynamics, the maximum engine speed is limited to 7,000 rpm when the vehicle is standing.

Warming up the engine

During the warm-up phase, the high-performance V8 engine runs a little more roughly due to its emissions control system.

For technical reasons, the exhaust system sounds slightly metallic when the engine is cold.

For further information on warming up the engine, refer to Tachometer on page 73 and Engine oil temperature on page 74.

Compound brake



Your BMW M3 is equipped with a high-performance brake system with perforated compound brake discs.

Due to special design features of the perforated compound brake discs, operating noise is audible during braking. However, this does not affect the brake's performance, safe operation or stability under load.

Braking correctly

To keep the brake system in optimal condition, it is advisable to apply the brakes at regular intervals as appropriate for the character of the vehicle.

Refer also to Corrosion on brake rotors on page 125.

Drive train

In your BMW M3, special emphasis was placed on the direct connection between the engine and drive. The torsionally rigid execution of the drive train results in acoustic feedback of the torque, as is typical in sports cars. Clacking sounds can arise during load changes. They do not impair functionality or shorten the lifespan of any component.

Driving on a race track

BMW recommends the following measures before driving on a race track:

- ▷ Participate in a BMW driver training course
- ▷ Have the vehicle checked by your BMW center

 Operation on a race track can lead to increased wear. The BMW M3 is not designed for use in competitive motorsports. This wear is not covered by the vehicle warranty. ◀

The series brake pads and wear indicator are not designed for operation on a race track. Your BMW center will be glad to advise you.



Navigation

This chapter describes how you can enter destinations and specify your route so that your navigation system guides you reliably to your destination.

Starting the navigation system*

Your navigation system can use satellites to ascertain the precise position of your vehicle and guide you reliably to any destination you enter.

Navigation DVD

The navigation system requires a special navigation DVD. You can obtain the latest version at your BMW center.

Inserting navigation DVD



Use the lower drive for navigation DVDs.

1. Insert the navigation DVD with the labeled side up.
The navigation DVD is pulled in automatically.
2. Wait for several seconds to allow the contents of the DVD to be read in.

Removing navigation DVD

1.  Press button 1.
The DVD emerges slightly from the drive.
2. Remove the DVD.

If the DVD is not ejected, the drive may be blocked. In this case, a message will appear on the Control Display.

Display in the assistance window

You can display the route or the current position in the assistance window. This display remains visible even if you change to another application.

1. Move the controller to the right to enter the assistance window.



2. Press the controller.
Other menu items are displayed.
3. Select the desired route view or "Current position".



4. Press the controller.

Showing arrow display in map view*

When the navigation system suggests a change in direction, the arrow display appears briefly. iDrive, for operating principle refer to page 16.

1. Press the **MENU** button.
This opens the start menu.
2. Press the controller to open the **i** menu.

3. Turn the controller until "Settings" is selected and press the controller.
4. Turn the controller until "Language / Units" is selected and press the controller.
5. If necessary, move the highlight marker to the uppermost field. Turn the controller until "Languages" is selected and press the controller.
6. Select "Arrow display pop-up instructions" and press the controller.

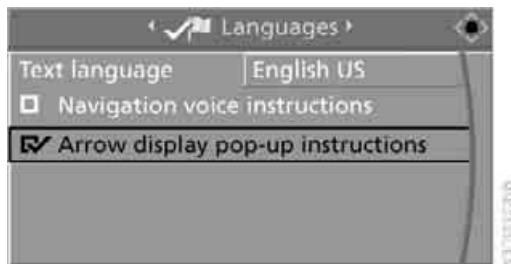

The arrow view is displayed in the assistance window.

Destination entry

In entering your destination you can select from the following options:

- ▷ Entering a destination manually, see below
- ▷ Entering a destination by voice commands*, refer to page 140
- ▷ Selecting destination using information, refer to page 142
- ▷ Selecting destination from a list, refer to Destination list, page 143
- ▷ Selecting destination from address book, refer to page 144
- ▷ Selecting home address, refer to page 146

After selecting your destination you can proceed to start the destination guidance, refer to page 149.

You can also store a navigation destination on the programmable memory keys, refer to page 21.

 Enter data only when the vehicle is stationary, and always give priority to the applicable traffic regulations in the event of any contradiction between traffic and road conditions and the instructions issued by the navigation system. Otherwise, vehicle occupants and other road users may be endangered. ◀

Opening navigation

iDrive, for operating principle refer to page 16.

1. Press the **MENU** button.
This opens the start menu.
2. Move the controller to the right to call up "Navigation".



3. Select "Navigation" and press the controller.



The following is displayed on the Control Display:

- ▷ The arrow or map view during destination guidance
- ▷ The destination list when destination guidance is switched off

Entering a destination manually

The system's word-matching principle makes it easier for you to enter the names of streets or towns, refer to page 148. This allows you to enter different spellings and completes your entry automatically so that stored names can be called up quickly.

1. If necessary, move the highlight marker to the uppermost field. Turn the controller until "Navigation" is selected and press the controller. "New destination" is selected.
2. Press the controller.



3. Select "Enter address" and press the controller.



The system also supports you with the following features:

- ▶ If you do not enter a street, the system will guide you to the downtown area of a town or city.
- ▶ You can skip the entry of country and locality if the current entries should be retained for your new destination.

Selecting country

1. Select "State / Province" or the country displayed and press the controller. The list of available countries appears on the display.



2. Select the country of destination and press the controller.

At least the town/city of the destination or its zip code must be entered in order to start the destination guidance.

Entering destination by town/city name

1. Select "Town / City" or the town/city displayed and press the controller.
2. Select the starting letter and press the controller. A list of all towns/cities starting with this letter appears on the Control Display.
3. Delete letters, if necessary:



- ▶ To delete individual numbers or letters: Move the controller towards the right to select **←|** and press the controller.
- ▶ To delete all numbers or letters: Move the controller toward the right to select **←|** and press the controller for a longer period.

- If necessary, enter more letters. The list gradually grows smaller each time you enter a new letter.
 - ▶ To enter spaces, if necessary: Select the _ symbol and press the controller.



- If necessary, move the highlight marker to the third field from the top. Turn the controller until the city or town name is selected from the list and press the controller.

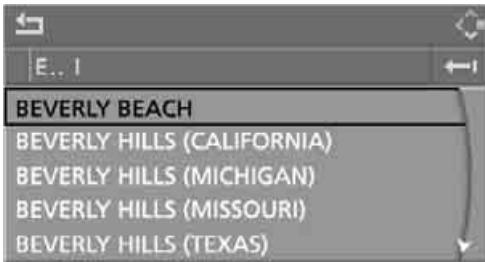

Entering destination by zip code

- Select "Town / City" and press the controller.
- Enter the zip code: Select the desired digits and press the controller.



- ▶ To enter spaces: Select the _ symbol and press the controller.
 - ▶ To delete individual numbers or letters: Move the controller towards the right to select ←| and press the controller.
 - ▶ To delete all numbers or letters: Move the controller toward the right to select ←| and press the controller for a longer period.
- Select the zip code and press the controller. The corresponding destination is displayed.
 - Move the highlight marker to the third field from the top. Turn the controller until the destination is selected and press the controller.

Entering street, house number and intersection

After the street you can also enter the intersection or the house number.

Entering street and intersection

1. Select "Street" or the street displayed and press the controller.
2. Enter the street.
The street is entered in the same manner as the town or city.



The intersection is entered in the same way as the street.

Entering a street without entering a town/city

You can also enter a street without specifying a town/city. In this case, all streets of the same name in the designated country are offered. The corresponding town/city is displayed after the street name.

If a town/city has already been entered, you can negate this entry. This could be helpful in instances where the desired street does not exist in the entered town/city because it belongs to another suburb, for example.

1. Move the highlight marker to the uppermost field.
The  arrow is selected.



2. Turn the controller to the right until you see a request to enter a street in the country, then press the controller.



3. Switch to the second field from the top and enter the street.

Entering a house number

You can enter any house number stored for the street on the navigation DVD.

1. Select "House number" and press the controller.
2. To enter the house number:
Select the desired digits and press the controller.
3. Move the highlight marker to the third field from the top. Turn the controller until the house number is selected and press the controller.

Starting destination guidance with manual destination entry

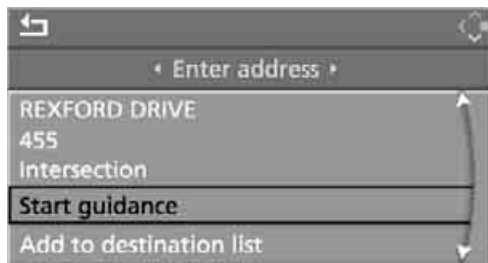

- ▶ Select "Start guidance" and press the controller.
Destination guidance starts immediately.
- ▶ If you do not want to start destination guidance right away:
Select "Add to destination list" and press

the controller.

The destination is stored in the destination list, refer to page 143.

Entering a destination by voice commands*

You can enter a desired destination via the voice command system. During the destination input, you can switch between voice entry and entry via iDrive at any time. To do so, reactivate the voice command system if necessary.

 You can have the possible commands read aloud via ›Options‹. ◀

1. Press the  button on the steering wheel or in the center console.

 2. ›Enter address‹



Selecting country

1. Wait for the system to ask for the country of destination.

 2. Say the name of the destination country.

Say the name of the destination country in the language of the voice command system.

Entering a destination

The destination can be spelled or entered as an entire word.

Spelling the destination

To enter a destination, spell it in the way it is commonly spelled in the destination country. Pronounce the letters smoothly and at normal

volume, avoiding excessive emphases and pauses.

 1. To spell the name of a town/city: Say at least the first three letters of the town/city. The more letters you say, the more accurately the system will recognize the town/city.

The system can suggest up to 20 destinations that meet your entries. Up to 6 entries at a time appear on the Control Display.



 The system suggests a location.

2. Select location:

- ▶ To select highlighted town/city: ›Yes‹
- ▶ To select other town/city: ›No‹
- ▶ To select an entry, e.g. ›Entry 3‹
- ▶ To show other entries in the list: ›Next page‹
- ▶ To respell the town/city: ›Repeat‹

The town/city can also be selected from the list via iDrive:

Turn the controller until the destination is selected and press the controller.

Entering the destination as an entire word*

The names of towns/cities and streets located in the region in which the language of the voice command system is spoken can be entered as an entire word.

Example: to enter a U.S. destination as an entire word, the system language must be English.

Speak smoothly and at normal volume, and avoid excessive emphases and pauses.

1. Wait for the system to ask for the town/city of destination.
2. Say the name of the destination town/city.

The system can suggest up to 6 destinations that fit your entries.



- The system suggests a location.
3. Select location:
 - ▶ To select highlighted town/city: ›Yes‹
 - ▶ To select other town/city: ›No‹
 - ▶ To select an entry, e.g. ›Entry 3‹
 - ▶ To re-enter the town/city: ›Repeat‹
 - ▶ To enter the town/city by spelling: ›Spell‹

The town/city can also be selected from the list via iDrive:

Turn the controller until the destination is selected and press the controller.

- ▶ Identical-sounding towns/cities that cannot be distinguished by the system are compiled in a separate list and shown as a destination followed by three dots. If applicable, select this entry with ›Yes‹. Then select the desired town/city from that list. ◀

Entering street and house number

The street is entered in the same way as the destination town/city.

To enter the house number:

1. ›House number‹
2. Say the house number.

House numbers of up to 4 digits can be entered. Say the house number as individual digits.

Starting destination guidance

▶Start guidance‹

Destination guidance starts immediately.

Storing destinations

Destinations are added to the destination list or can be stored in the address book.

- ▶Add to destination list‹ or
▶Add to address book‹

Map-guided destination selection

If you only know the location of the town or street of destination, you can enter the destination using a map. You can use the cross-hairs to select the destination on the map and then transfer it for destination guidance.

1. Select "Navigation" and press the controller. "New destination" is selected.
2. Press the controller.



3. Select "Input map" and press the controller.

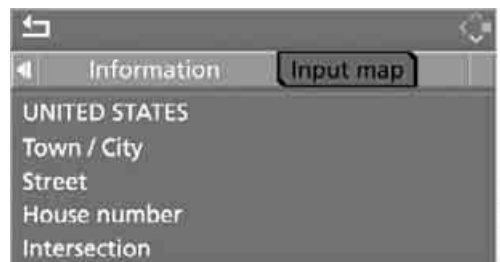

A section of a map is displayed on the Control Display:

- ▷ During destination guidance, around the current destination
- ▷ With the destination guidance deactivated, around the last destination entered



4. Select the destination with the cross-hairs.
 - ▷ To change the scale: turn the controller.
 - ▷ To move the map: move the controller in the desired direction.
The controller can be moved to the left, right, forwards and backwards.
5. Press the controller to transfer the destination for destination guidance or to store it. The selected destination and other menu items are displayed.

6. Select the desired menu item:
 - ▷ "Start route guidance" starts destination guidance.
 - ▷ "Show current position" places your current position at the center of the map.
 - ▷ "Show destination position" places the current destination at the center of the map.
 - ▷ "Return to map" changes back to the "Input map".
 - ▷ ↩ Exit the menu.

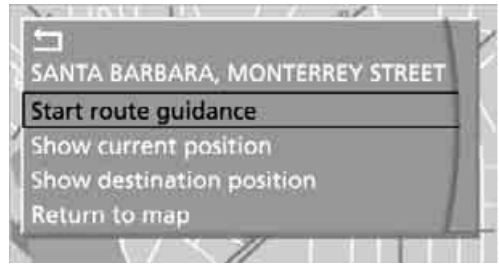

7. Press the controller.

The map for destination entry can also be called up in the map display:

Select the  symbol and press the controller.

Selecting destination using information

You can have a list of selected destinations displayed, e.g. hotels, sights or hospitals, and transfer them for destination guidance.

1. Select "Navigation" and press the controller.
2. Select "Information" and press the controller.

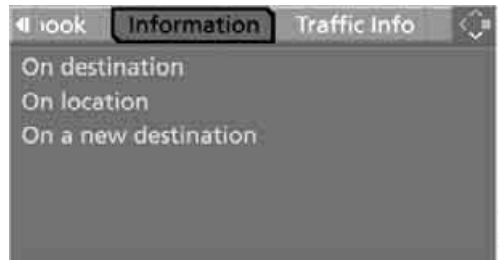

3. Select location:
 - ▷ "On destination"
 - ▷ "On location"
 - ▷ "On a new destination"

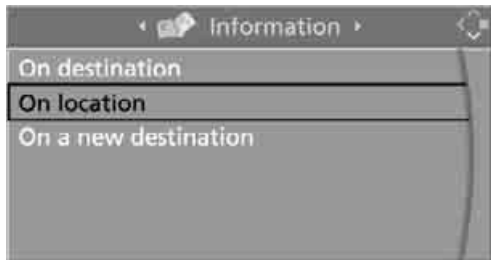

4. Press the controller.
5. Make your selection, e.g. "Hotels and restaurants", and press the controller.
6. Enter search criteria if necessary, e.g. the maximum distance from your location.
7. Select "<Start search>" and press the controller. Destinations are shown on the Control Display.



8. Select a destination and press the controller.
 - ▶ The scope of information and symbols depends on the particular navigation DVD you are using. ◀
9. Select the desired menu item:
 - ▷ To transfer the address to the destination list and start destination guidance:

Select the symbol and press the controller.

- ▷ To establish a telephone connection: Select the symbol and press the controller.
- ▷ To display additional destinations: Select the symbol and press the controller.
- ▷ To start a new search: Select the symbol and press the controller.

To exit from the menu:
Select the arrow and press the controller.

Symbols in the map display

If you select the hotel category, for example, and start a search, hotels appear on the map as symbols.

To hide the symbols in the map display:

1. Select the symbol and press the controller.



2. Select "Hide map icons" and press the controller.

The symbols are hidden.

To show the symbols:
Select "Show map icons" and press the controller.

To exit from the menu:
Select the arrow and press the controller.

Destination list

The last 20 destinations entered into the system are shown in the destination list. You can call up these destinations and transfer them for

destination guidance.

If you are planning a longer journey, for example, you can store all the destinations you wish to drive to in the destination list in advance, refer to Entering a destination manually on page 136.

Select "Navigation" and press the controller.



The destination last entered is listed first in the destination list.

➡ This symbol identifies the current destination during destination guidance.

To show other destinations in the destination list:

Turn the controller.

Transferring destination for destination guidance

1. Select the desired destination from the destination list and press the controller.
2. Select "Start guidance" and press the controller.

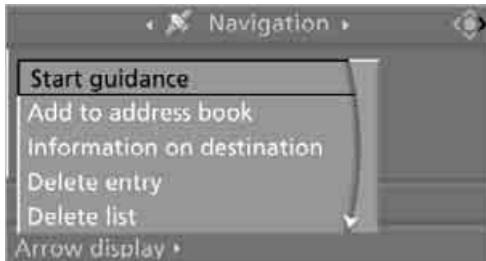

Editing destination list

1. Select the desired destination from the destination list and press the controller.
2. The selected destination can be edited:
 - ▷ To store the entry: Select "Add to address book".
 - ▷ To display information on the destination: Select "Information on destination".
 - ▷ To delete the entry: Select "Delete entry".
 - ▷ To delete all entries: Select "Delete list". The destination guidance is switched off.
 - ▷ To change an entry: Select "Edit". For operation, refer to Entering destination by town/city name, page 137.
3. Press the controller.

Address book

Opening address book

iDrive, for operating principle refer to page 16.



Select "Address book" and press the controller.

Storing destinations in address book

You can store approx. 100 destinations in the address book.

1. Select "Address book" and press the controller.
2. Select "New address" and press the controller.

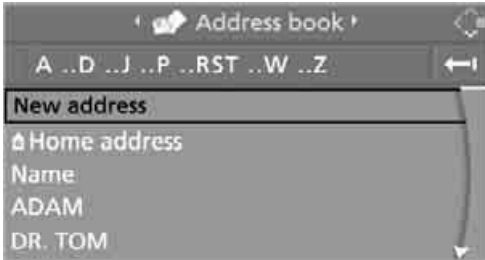

3. Select "Enter address" and press the controller.
4. Enter the name and address, refer also to Entering a destination manually, page 136.
5. Select "Store in address book" and press the controller.

The entry is stored in the address book.

You can also store a destination from the destination list in the address book, refer to page 143.

Storing current position*

The current position can be transferred to the address book.

1. Select "Address book" and press the controller.
2. Move the highlight marker to the third field from the top. Turn the controller until "New address" is selected and press the controller.

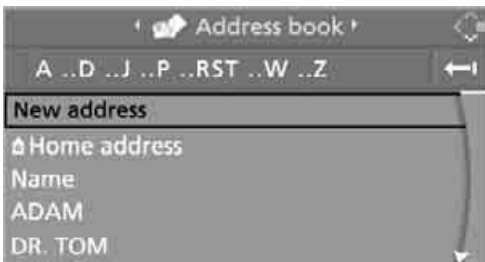

3. Select "Use current location as address" and press the controller. The name given can be changed. For oper-

ation, refer to Entering a destination manually, page 136.

4. Select "Store in address book" and press the controller.

You can also enter your current position into the address book if you have left the area covered by the navigation DVD. In this case, you must enter a name.

Selecting destinations from address book

1. Select "Address book" and press the controller. The stored entries appear on the Control Display.



2. Select the entry and press the controller.

To start destination guidance:

Select "Start guidance" and press the controller.

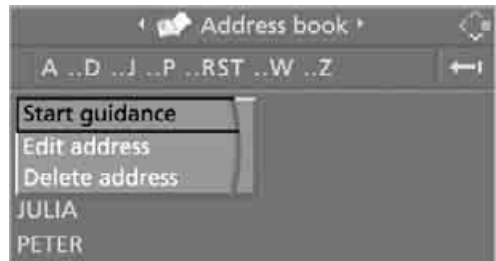

Changing destinations from address book

1. Select "Address book" and press the controller.
2. Select the entry and press the controller.

3. Select "Edit address" and press the controller.



4. Change entry.
For operation, refer to Entering a destination manually, page 136.
5. Select "Store in address book" and press the controller.

Deleting individual destinations from address book

1. Select "Address book" and press the controller.
2. Select the entry and press the controller.
3. Select "Delete address" and press the controller.

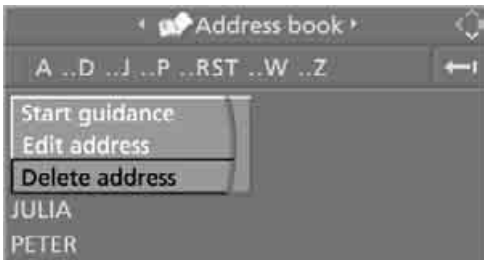

Deleting all destinations from address book

1. Open the start menu.
2. Press the controller to open the **i** menu.
3. Select "Settings" and press the controller.
4. Select "Vehicle / Tires" and press the controller.
5. If necessary, move the highlight marker to the uppermost field. Turn the controller

until "Delete data" is selected and press the controller.



6. Select "Delete address book" and press the controller.
7. Select "Yes" and press the controller.

Home address

You can store your current position or the current destination as the home address in the address book. This entry occupies the second position in the address book.

Storing home address

1. Select "Address book" and press the controller.
2. Move the highlight marker to the third field from the top. Turn the controller until "Home address" is selected and press the controller.

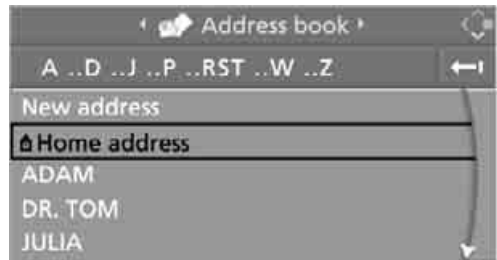

3. Select "Use current location as address" or "Save current destination" during destination guidance and press the controller.
4. Select "Store in address book" and press the controller.

Using home address as destination

1. Select "Home address" and press the controller.
2. Select "Start guidance" and press the controller.

Changing home address

1. Select "Home address" and press the controller.
2. Select "Edit address" and press the controller. For operation, refer to Entering a destination manually, page 136.

Route selection

You can influence the calculated route by choosing certain route criteria. You can change the route criteria as often as you like during destination entry or during destination guidance.

The route is planned according to fixed rules. The type of road is taken into account, e.g. whether it is a highway or a winding road. The road types are stored on the navigation DVD. As a result, the routes recommended by the navigation system may not always be the same ones that you would choose based on personal experience.

Changing route criteria

1. Select "Navigation" and press the controller.
2. Move the highlight marker to the third field from the top. Turn the controller until "Route preference" is selected and press the controller.

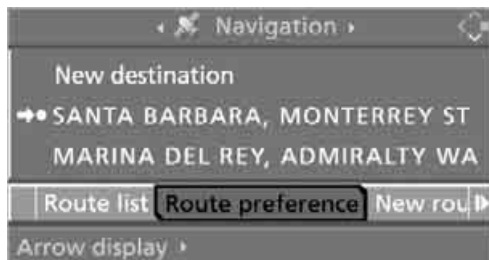

The various criteria are shown on the Control Display.

3. Select a route criterion for the route:
 - ▷ "With highways"

Highways and major traffic arteries are given priority.
 - ▷ "Avoid highways"

Highways are avoided as far as possible.
 - ▷ "Fast route"

Fast route, being a combination of the shortest possible route and the fastest roads
 - ▷ "Short route"

Short route, irrespective of how fast or slow progress will be
4. Press the controller.

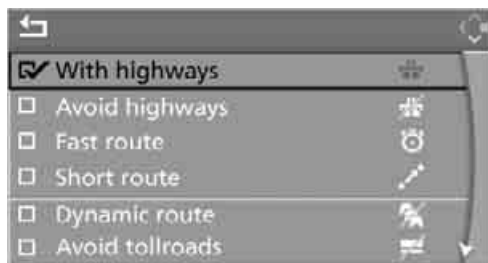

The route criterion is selected.

5. If necessary, select an additional route criterion and then press the controller:
 - ▷ "Dynamic route"

Automatic rerouting due to traffic obstructions. Depending on road type and the kind and extent of the traffic obstruction, the guided route may lead through the traffic obstruction.
 - ▷ "Avoid tollroads"

Toll roads are avoided as far as possible.
 - ▷ "Avoid ferries"

Ferries are avoided as far as possible.

To exit from the menu:

Select the  arrow and press the controller.

The route criteria can also be changed in the arrow or map display.

1. Select the symbol for the route criterion and press the controller.
2. Select a route criterion and press the controller.

 If the "Avoid highways", "Avoid tollroads" or "Avoid ferries" route criteria are selected, route calculation may take considerably longer. ◀

Word-matching principle

The system's word-matching principle makes it easier for you to enter the names of towns or streets. The system runs ongoing checks, comparing your destination entries with the data stored on the navigation DVD as the basis for instant response. The benefits for you include:

- ▷ Names of towns entered may differ from the official versions if you are using a spelling that is customary in another country.

Example:

Instead of the German spelling "München" you can also enter the English spelling "Munich" or the Italian spelling "Monaco".

- ▷ When you are entering the names of towns and streets the system will complete them automatically as soon as enough letters are available to ensure unambiguous identification.
- ▷ The system offers only those letters for selection of name entries that are stored on the navigation DVD. Thus, entry of erroneous or unregistered names is impossible.

Destination guidance

Starting destination guidance

Via iDrive

iDrive, for operating principle refer to page 16.

1. If necessary, move the highlight marker to the uppermost field. Turn the controller until "Navigation" is selected and press the controller.
2. Select the destination from the destination list and press the controller or enter a new destination, refer to page 136.



3. Select "Start guidance" and press the controller.

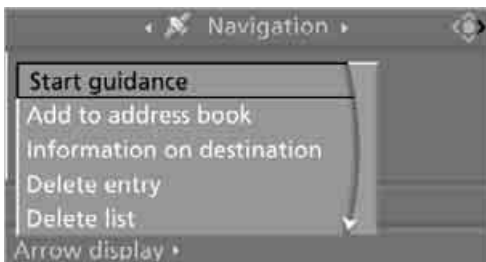

After the route has been calculated, destination guidance is indicated by arrows or a map display on the Control Display.



Destination guidance can also be started in the arrow or map display:

Select the  symbol and press the controller.

During destination guidance, you can operate other equipment items at any time via iDrive. You will be notified in time of any necessary

change of direction by means of spoken instructions and the display of the direction arrows.

Via programmable memory keys

 ...  Press the key on which the desired destination has been stored, refer also to page 21.

Terminating/continuing destination guidance

In the arrow or map display

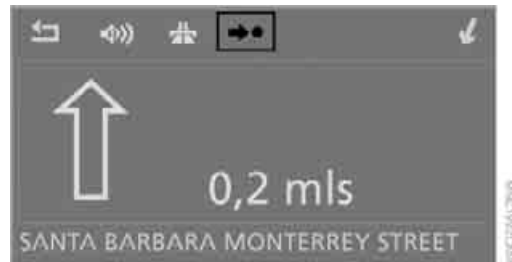

Select the  symbol and press the controller.

In the destination list

 This symbol indicates the current destination.

1. Select the current destination and press the controller.



2. Select "Stop guidance" and press the controller.

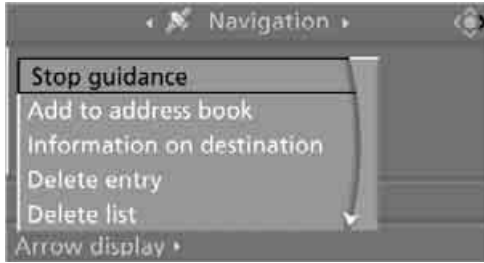

If you did not reach the destination before the end of the last journey, the following question will appear in the display at the start of the next journey:
"Continue guidance to destination?".

The destination guidance starts automatically after a short time.

To start destination guidance immediately:
Select "Yes" and press the controller.

Route display

You can have the route during destination guidance displayed in various ways.

 From another menu, you can switch directly to the screen last displayed, refer to Convenient call-up of menu items on page 18.◀

Arrow display

1. Select "Navigation" and press the controller.
2. Move the highlight marker to the fourth field from the top. Turn the controller until

"Arrow display" is selected and press the controller.



The arrow display is shown.



- 1 Switching voice instructions on/off
- 2 Selecting route criteria
- 3 Starting/stopping destination guidance
- 4 Arrow to destination as the crow flies
- 5 Distance to the next change of direction
- 6 Current location
- 7 Direction of travel
 - ▷ Outline of an arrow: Destination guidance on the calculated route
 - ▷ Solid arrow: Arrow points as the crow flies to the calculated route whenever the vehicle is not in an area recorded on the navigation DVD, e.g. in a parking garage.

Depending on your vehicle's equipment, the projected time of arrival and distance to the destination is displayed in the top or bottom line of the Control Display.

The arrows change appearance before a change of direction.



- 1 Street name for change of direction
- 2 Distance to change of direction
- 3 Change of direction

To exit from the menu:
Select the arrow and press the controller.

Map display

You can have your current position displayed on a map. After starting the destination guidance, the planned route is shown on the map.

1. Select "Navigation" and press the controller.
2. Move the highlight marker to the fourth field from the top. Turn the controller until the desired map display is selected:
 - ▷ "Map facing north"
 - ▷ "Map direction of travel"
 - ▷ "Perspective"

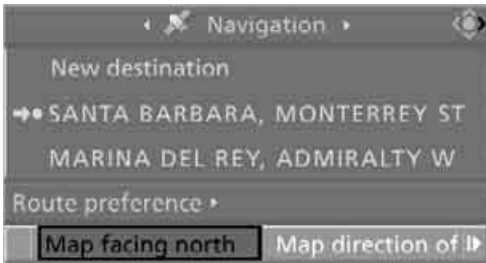

3. Press the controller.



- 1 Switching voice instructions on/off
- 2 Starting/stopping destination guidance
- 3 Map-guided destination selection
- 4 Displaying the menu in which the information last selected can be shown/hidden, refer to [Selecting destination using information](#), page 142
- 5 Changing map display
 - ▷ "Map facing north"
 - ▷ "Map direction of travel"
 - ▷ "Perspective"
- 6 Changing route criteria
- 7 Calling up traffic information* manually
- 8 Arrow to destination as the crow flies

The projected time of arrival and distance to the destination is displayed in the bottom line of the Control Display.

To exit from the menu:
Select the arrow and press the controller.

At scales of less than 250 miles/500 km, you can have the map shown facing north or toward your current direction of travel, or in perspective. At scales of 250 miles/500 km or greater, the map is always north-oriented.

Changing map display



Select the corresponding symbol and press the controller.
The next map display is displayed.

Changing scale

Turn the controller to adjust the scale.

Displaying towns/cities and streets along the route

You can have the roads and towns along the route displayed during destination guidance.

The distances remaining to be traveled within each section of the route are also displayed.

1. Select "Navigation" and press the controller.
2. Move the highlight marker to the third field from the top. Turn the controller until "Route list" is selected and press the controller.

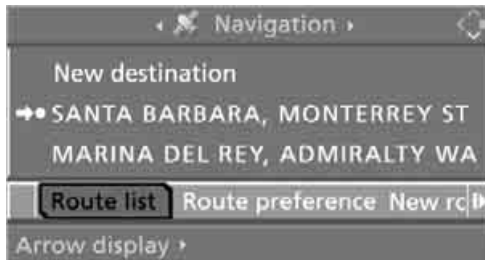

To exit from the menu:
Select the  arrow and press the controller.

Destination guidance through voice instructions

Switching voice instructions on/off

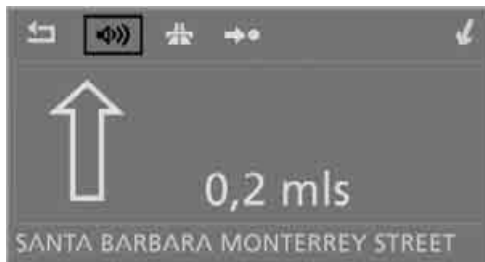

Voice instructions can be switched on or off during the destination guidance in the arrow or map display:

Select the  symbol and press the controller.

To switch the voice instructions on/off at any time:

1. Press the **MENU** button.
This opens the start menu.
2. Press the controller to open the **i** menu.
3. Turn the controller until "Settings" is selected and press the controller.



4. Turn the controller until "Language / Units" is selected and press the controller.
5. If necessary, move the highlight marker to the uppermost field. Turn the controller until "Languages" is selected and press the controller.

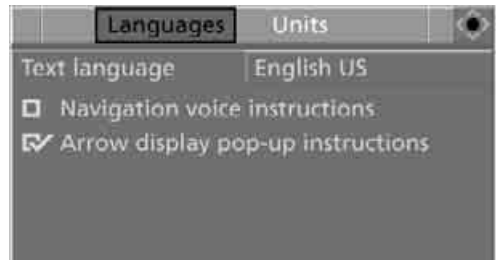

6. Select "Navigation voice instructions" and press the controller.

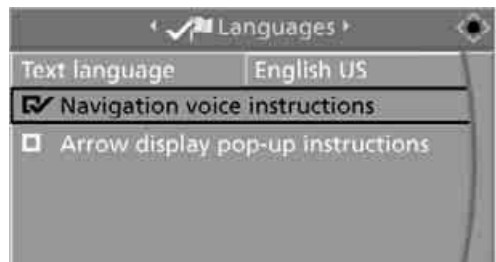

 The voice instructions are switched on.

Repeating or canceling voice instructions

With the programmable buttons on the steering wheel, you can also execute the following functions, refer to page 16:

- ▷ Repeat the voice instruction:
Press the button.
- ▷ Switch voice instructions on/off:
Press the button for a longer period.

Adjusting volume for voice instructions

The volume can be adjusted only while a voice instruction is being issued.

1. Have the last voice instruction repeated, if necessary.
2. Turn the button during the voice instruction to select the desired volume.

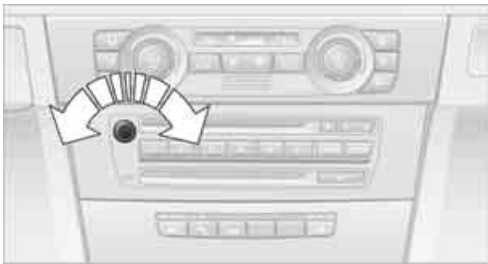

This volume is independent of the volume of the audio sources.

The setting is stored for the remote control currently in use.

Changing a route

During destination guidance, you can revise the navigation system's route recommendations to avoid particular stretches of road. Enter the number of miles/kilometers that you want to travel before returning to the original route.

1. Select "Navigation" and press the controller.
2. Move the highlight marker to the third field from the top. Turn the controller until "New route" is selected and press the controller.



3. Turn the controller to enter the desired number and press the controller.

The route is recalculated.

To exit from the menu without changing the route:

Select the  arrow and press the controller.

Traffic information*

In many metropolitan areas you can receive traffic information broadcast by radio stations. The traffic conditions are monitored by traffic control centers and the traffic information is updated periodically.

During destination guidance, the traffic information relevant to the route you are planning to take is automatically shown and, if desired, taken into account in route planning. Whether destination guidance is active or not, you can have the traffic information displayed in the map view or in the traffic info list.

Switching reception of traffic information on/off

iDrive, for operating principle refer to page 16.

1. Press the **MENU** button.
This opens the start menu.
2. Press the controller to open the **i** menu.

- Turn the controller until "Settings" is selected and press the controller.



- Turn the controller until "Traffic Info settings" is selected and press the controller.

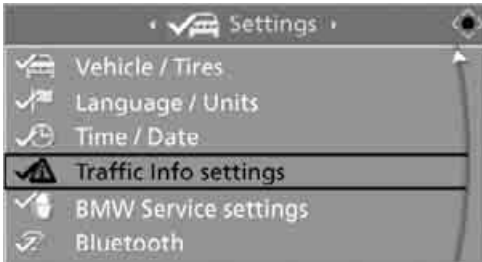

- Select "Traffic Info" and press the controller.

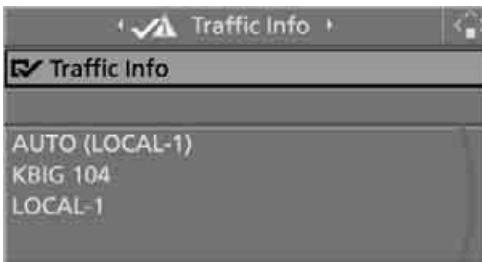

The traffic information can be received and displayed.

"AUTO": automatic selection of the Traffic Info station with the best reception.

Depending on the station, either the station name, frequency, local number or other information is displayed. ◀

Calling up traffic information manually

During destination guidance

During destination guidance, traffic information can be displayed in the arrow or map view.

If the symbol is shown with a red border, traffic information is available for the planned route.

Select the symbol and press the controller.



During destination guidance, traffic information items along the planned route are indicated by yellow diamonds.

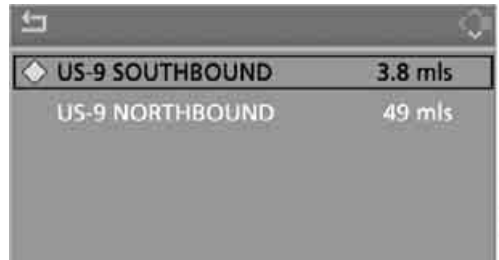

Traffic information on the planned route is shown first, sorted by distance from the vehicle's current position.

With destination guidance switched off

- Open the start menu.
- Move the controller to the right to call up "Navigation".

3. Select "Traffic Info" and press the controller.

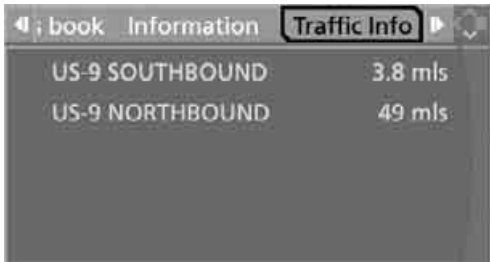

Traffic information on the planned route is shown first, sorted by distance from the vehicle's current position.

Displaying traffic information in map display

The traffic information icons are shown in the map display up to a scale of 100 miles/200 km.

The highlighting of the stretch corresponding to the traffic report and the icons for the type of event as described below are displayed and hidden. This depends on the selected scale.

Displaying detailed traffic information





















Select a traffic information item from the list and press the controller.





To exit from the menu:





Select the  arrow and press the controller.

Traffic information icons

-  Traffic event displayed with map scales larger than 5 miles/10 km; arrow points in relevant direction of travel.
-  There are several traffic events. Switch to a smaller map scale to show more detail.
-  Traffic light failure
-  Roadworks
-  General traffic obstruction
-  Transport of hazardous load
-  Vehicle on wrong carriageway
-  Danger
-  Low clearance
-  No parking
-  Fog
-  Heavy rain
-  Slippery road
-  Cross winds
-  Smog
-  Road closed
-  Slow traffic
-  Traffic backup
-  Stopped traffic
-  Icy roads
-  Uneven surface
-  Accident

-  Lane closure
-  Delay
-  Police checkpoint



-  Slow traffic or other traffic event
-  Stop and go traffic
-  Stopped traffic
-  Traffic events in both directions of travel

Traffic information during destination guidance

In the event of a traffic obstruction on the planned route, the traffic information icons are shown with a red border.

System response will vary depending on whether or not "Dynamic route" is selected, refer to page 147.

Displaying traffic obstructions

When the navigation system receives a traffic obstruction message and "Dynamic route" is not selected, you are shown certain information, such as the length of the traffic congestion, when you are approx. 25 miles/40 km away from the traffic obstruction.

The last possible detour exit is indicated just before you reach it.



Select "Detour" and press the controller. The navigation system calculates a new route to avoid the congestion.

This information is displayed even if you have called up another application on the Control Display.

Dynamic route planning

When "Dynamic route" is selected, the route will be changed automatically in the event of a traffic obstruction. The system does not point out traffic obstructions on the original route. Depending on road type and the kind and extent of the traffic obstruction, the calculated route may lead through the traffic obstruction.

Displaying current position

You can have your current position displayed even when the destination guidance is switched off.

1. Select "Navigation" and press the controller.
2. Move the highlight marker to the fourth field from the top. Turn the controller until "Current position" is selected and press the controller.

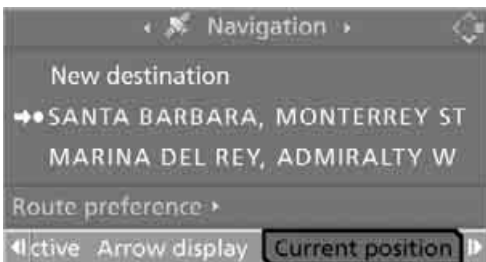

The current position of your BMW is displayed.

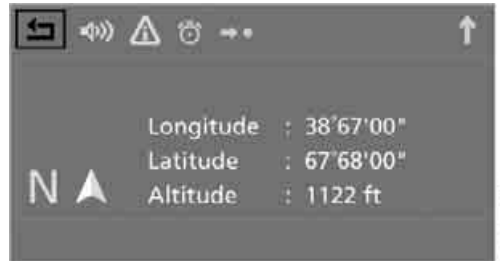

If the navigation system is unable to identify a town or city, your current map coordinates will appear.

To exit from the menu:

Select the  arrow and press the controller.

You can also have the current position displayed on a map, refer to page 151.

What to do if ...

What to do if ...

- ▷ a navigation DVD is inserted, but an instruction to insert the DVD appears on the Control Display?

The navigation DVD may not be the correct DVD for the navigation system. This information is indicated on the DVD label.

- ▷ you request the current position of your vehicle, but do not receive a precise display?

The system is unable to receive enough GPS signals at your current position due to obstructions, your current position is not yet available on your navigation DVD, or the system is in the process of calculating your current position. As a rule, reception is guaranteed when you are in the open.

- ▷ the destination guidance does not accept a destination?

The data of the destination is not stored on the navigation DVD that is loaded. Choose a destination as close as possible to the original one.

- ▷ the destination guidance does not accept an address without the street name?

On the navigation DVD, no downtown area can be determined for the city or town entered. Enter any street, or a destination such as the railway station in the selected town, and then start the destination guidance.

- ▷ you want to enter a destination for the destination guidance, but it is not possible to select the letters for your desired entry?

The data of the destination is not stored on the navigation DVD that is loaded. In this case, the system will not offer you any letters to choose from. Choose a destination as close as possible to the original one.

- ▷ the system stops furnishing directions on which way to turn as you approach intersections?

You are driving in an area that has not yet been completely recorded on the naviga-

tion DVD. Instead of an arrow indicating a turn, you will see an arrow which indicates the general direction of your planned route. Or you have left the recommended route and the system requires a few seconds to calculate a new recommended route.

- ▷ the navigation system does not react to entries?

If the battery was disconnected, it takes about 10 minutes before the system is once again operational.





Entertainment

Operation of the radio, CD equipment and external audio devices as well as their tone settings are described in this chapter.

On/off and settings

The following audio sources have shared controls and setting options:

- ▷ Radio
- ▷ CD player
- ▷ CD changer*



Controls

The audio sources can be operated using:

- ▷ Buttons near the CD player
- ▷ iDrive
- ▷ Buttons on the steering wheel, refer to page 11
- ▷ Programmable memory keys, refer to page 21

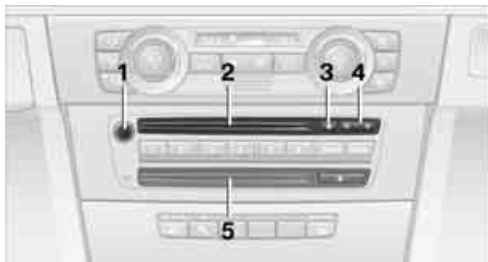
Buttons on the CD player



- 1 Sound output for entertainment on/off, volume
 - ▷ Press: switch on/off.
When you switch on the unit, the last set radio station or track is played.
 - ▷ Turn: adjust volume.
- 2 Drive for audio CDs
- 3  Eject CD.
- 4  Station scan/track search
 - ▷ Change radio station.
 - ▷ Select track for CD player and CD changer.
- 5 Drive for navigation DVD

Operation via iDrive

iDrive, for operating principle refer to page 16.

1. Press the **MENU** button.
This opens the start menu.
2. Move the controller backwards to call up "Entertainment".

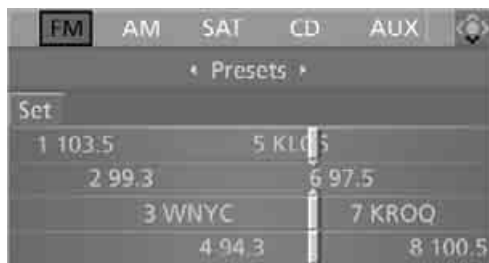

You have the following choices:

- ▷ "FM" and "AM": radio reception
- ▷ "SAT": satellite radio*
- ▷ "CD": CD player or changer*
- ▷ "AUX": AUX-In port, USB-audio interface*
- ▷ "Set": depending on the audio source, other adjustments can be made, e.g. with the radio: update station with strongest reception, store station, tone control, sample stations.

 From another menu, you can switch directly to the screen last displayed, refer to Convenient call-up of menu items on page 18. ◀

With the ignition at radio readiness or beyond, the selected audio source is stored for the remote control currently in use.

Switching on/off

In order to switch the entertainment sound output on and off:

Press button 1 on the CD player.

 This symbol on the Control Display indicates that sound output is switched off.

Adjusting volume

Turn knob **1** on the CD player until the desired volume is obtained.

You can also adjust the volume with buttons on the steering wheel, refer to page **11**.

With the ignition at radio readiness or beyond, the setting is stored for the remote control currently in use.

Tone control

You can alter various tone settings, e.g. treble and bass or the speed-dependent volume increase.

The tone settings are applied to all audio sources.

With the ignition at radio readiness or beyond, the settings are stored for the remote control currently in use.

Changing tone settings

1. Press the **MENU** button.
This opens the start menu.
2. Press the controller to open the **i** menu.
3. Turn the controller until "Settings" is selected and press the controller.
4. Select "Audio" and press the controller.



The tone settings can also be selected if you have called up "Entertainment" in the start menu:

Select "Set" and then "Tone", pressing the controller after each selection.

Treble and bass

1. Select "Treble / Bass" and press the controller.



2. Move the controller to the left or right to select "Treble" or "Bass".



3. Turn the controller until the desired setting is selected.

Balance and fader

You can adjust the volume distribution in the same manner as "Treble / Bass".

- ▷ "Balance": left/right volume distribution
- ▷ "Fader": front/rear volume distribution

Speed-dependent volume control

The speed-dependent volume control automatically increases the volume with increasing driving speed. You can set various stages for the increase in volume.

1. Select "Speed volume" and press the controller.

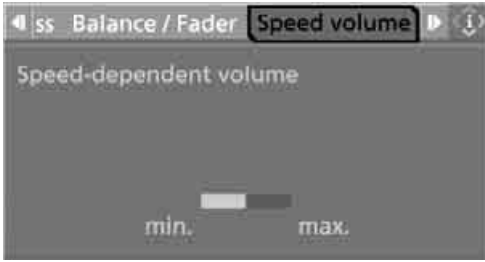

2. Turn the controller:
The adjustment is applied; the field can be changed.



Professional LOGIC7 HiFi System*

You can select a spatial sound effect that improves the spatial acoustics in all frequency ranges.

1. Select "Surround Settings" and press the controller.



2. Select "Concert hall" or "Theater".



3. Press the controller.

LOGIC7 spatial sound is switched on.

To switch off the spatial sound effect:
Select "Off" and press the controller.

LOGIC7 and the LOGIC7 logo are registered trade marks of Lexicon, Inc., a company of the Harman International Group.

Individual High-End Audio System*

You can choose between stereo and multichannel playback, surround.

1. Select "Surround Settings" and press the controller.
2. Select "Stereo" or "Surround".

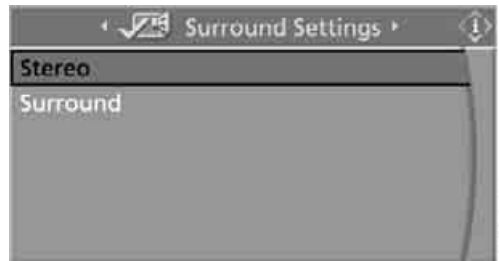

Equalizer*

You can set individual sound frequency ranges.

1. Select "Equalizer" and press the controller.



2. Move the controller to the left or right to select the desired frequency range.

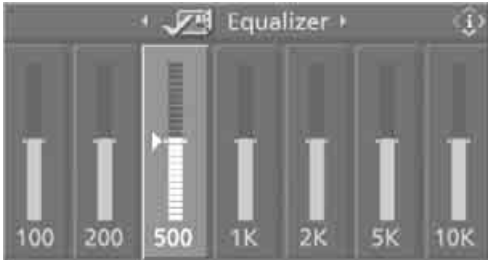

3. Turn the controller until the desired setting is selected.

Resetting tone settings

You can reset all tone settings to the default setting.

1. Open the start menu.
2. Press the controller to open the **i** menu.
3. Turn the controller until "Settings" is selected and press the controller.
4. Select "Audio" and press the controller.
5. If necessary, move the highlight marker to the uppermost field. Turn the controller

until "Reset" is selected and press the controller.



6. In vehicles equipped with two drives: Select "Yes" and press the controller.

Radio

Your radio provides reception of the FM and AM wavebands.

Listening to the radio



Press the button if the sound output is switched off.

iDrive, for operating principle refer to page 16.

1. Press the **MENU** button.
This opens the start menu.
2. Move the controller backwards to call up "Entertainment".
3. If necessary, move the highlight marker to the uppermost field. Select "FM" or "AM".



4. Press the controller.

Stations are shown on the Control Display on the basis of various selection criteria, e.g. "Presets".

If "Autostore" does not show a station in the AM waveband or if the displayed stations are no longer receivable, update the stations with the best reception, refer to page 167.

Changing stations



Turn the controller.

Buttons on the CD player

◀ ▶ Press the button for the corresponding direction.

The system switches to the next displayed station.

You can also change the station with the buttons on the steering wheel, refer to page 11.

Changing selection criteria

In addition to the stations currently displayed, you can have stations with another selection criterion displayed.

You can choose from the following selection criteria:

- ▷ "All stations"*:
Stations that can currently be received on the "FM" waveband.
- ▷ "Autostore":
Stations with the best reception on the "AM" waveband.
For High Definition Radio: stations with the best reception on the "FM" waveband.
- ▷ "Presets":
Stations you have previously stored, refer to page 168.
- ▷ "Manual":
To set stations that can be received in addition to those already being displayed, refer to Selecting the frequency manually, page 167.

To change the selection criterion:

1. Move the highlight marker to the second field from the top.
2. Choose a selection criterion and press the controller.



Sampling stations, Scan

The stations on the current waveband are automatically sampled in succession.

1. Select "FM" or "AM" and press the controller. "Set" is selected.
2. Press the controller. Other menu items are displayed.
3. Select "Scan" and press the controller.



The stations are sampled.

Stop sampling:

1. Press the controller.
2. Select "Scan" and press the controller.

Station sampling is interrupted and the selected station stays on.

Buttons on the CD player

 To sample stations, press the button for the corresponding direction for an extended time.

To stop scanning, press the button again.

Selecting the frequency manually

With "Manual" you can select stations that can be received in addition to those displayed.

1. Select "FM" or "AM" and press the controller.
2. Move the highlight marker to the second field from the top.
3. Select "Manual" and press the controller.



4. Turn the controller to set a certain frequency.

Updating stations with best reception

If on a longer journey you move out of the reception range of the stations originally received, you can update the list of stations received with the strongest signals in the AM waveband.

1. Select "AM" and press the controller.
2. Move the highlight marker to the second field from the top.
3. Select "Autostore" and press the controller. "Set" is selected.



4. Press the controller. Other menu items are displayed.

5. Select "Autostore" and press the controller.



The display of the stations with the strongest reception is updated. The frequencies of the stations are displayed.

Storing stations

Via iDrive

1. Select "FM" or "AM" and press the controller.
2. Move the highlight marker to the second field from the top. Turn the controller until the desired selection criterion is chosen and press the controller.
3. Select the desired frequency or station. "Set" is selected.



4. Press the controller. Other menu items are displayed.

5. Select "Store" and press the controller.

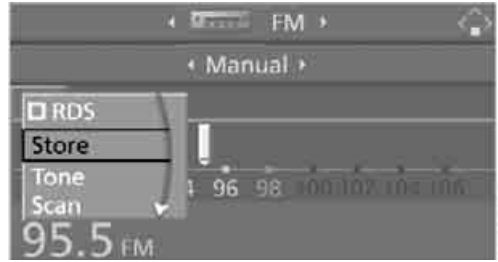

"Presets" is displayed.

6. Turn the controller until the desired memory location is selected.
7. Press the controller. The station is stored.



The channels of the last selection criterion are displayed once again after a short time.

With the ignition at radio readiness or beyond, the stations are stored for the remote control currently in use.

Via programmable memory keys

You can store a station on the programmable memory keys, refer also to page 21.

1. Select a station.
2.  Press the desired key for a longer period.

Changing a memory position

1. Select "Presets" and press the controller.
2. Select the desired station. "Set" is selected.
3. Press the controller. Other menu items are displayed.

4. Select "Store" and press the controller.



5. Turn the controller until the desired memory location is selected.
The number of the memory location appears beside the name or frequency of the station.
6. Press the controller.
The station is stored.

Radio Data System RDS

On the FM waveband, additional information is broadcast via RDS. If the reception conditions are good, the station names are shown on the Control Display. Where reception is poor or in the event of interference, it may take some time before the station names will appear in the display.

Switching RDS on/off*

1. Select "FM" and press the controller.
"Set" is selected.
2. Press the controller.
Other menu items are displayed.
3. Select "RDS" and press the controller.



RDS is activated.

The setting is stored for the remote control currently in use.

High Definition Radio*

Many stations transmit analog and digital signals. You can receive these stations digitally for improved sound quality.

A digital radio network must be available to be able to receive digital stations.

Switching digital radio reception on/off

iDrive, for operating principle refer to page 16.

1. Press the **MENU** button.
This opens the start menu.
2. Press the controller to open the **i** menu.
3. Turn the controller until "Settings" is selected and press the controller.
4. Select "Audio" and press the controller.
5. Move the highlight marker to the uppermost field. Turn the controller until "HD radio" is selected and press the controller.



6. Select "Off" and press the controller.
 Digital station reception is now switched on.
HD This symbol is displayed when a station is received digitally.



Some stations do not transmit the digital and analog signals simultaneously. If you are in an area in which digital reception of the selected station is not possible continuously, reception will alternate between analog and digital. This can cause repetitions or interruptions. In this case it may be preferable to switch off digital reception.

Selecting the programs of a digital station*

Some stations broadcast several programs on a single frequency. To select one of these programs:

1. Select "FM" or "AM" and press the controller.

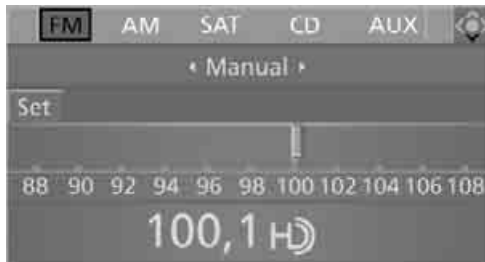

2. Select "Manual" and press the controller.
3. Select a station that can be received digitally. HD This symbol is displayed when a station is received digitally.
4. < > Change to the next program of the digital station using the buttons on the radio or steering wheel.

You can store a station, refer to page 168.

Updating digitally receivable stations

If on a longer journey you move out of the reception range of the stations originally received, you can update the list of stations received with the strongest signals.

1. Select "FM" or "AM" and press the controller.



2. Move the highlight marker to the second field from the top.
3. Select "Autostore" and press the controller.



4. Press the controller. Other menu items are displayed.
5. Select "Autostore HD" and press the controller.



The display of the digitally receivable stations is updated. This can take up to 2 minutes.

Displaying additional information

With digital stations, additional information on the current track can be displayed, e.g. the name of the artist.

1. Select the station and press the controller.
2. Select "Details" and press the controller.



 The information is displayed.



When you change to another digitally received station, any additional information is displayed after a brief interruption.

Satellite radio*

You can receive over 100 different channels with high sound quality.

The channels are offered to you in predefined packages. To receive the channels of your choice, you must have the corresponding packages enabled.

 With this new technology, signal losses can occur from time to time and result in audio interruptions. ◀

Enabling or disabling channels

iDrive, for operating principle refer to page 16.

1. Press the **MENU** button.
This opens the start menu.
2. Move the controller backwards to call up "Entertainment".
3. Select "SAT".



4. Press the controller.

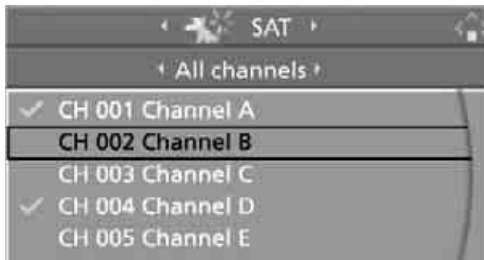

The channels are displayed.

✔ These channels are enabled.

Enabling

1. Select a channel that has not yet been enabled and press the controller.
A telephone number and the electronic serial number, ESN, are displayed.

 The electronic serial number is required for enabling or disabling. ◀

2. To enable the channel:
Dial the phone number.

Disabling

1. Select an enabled channel and press the controller.

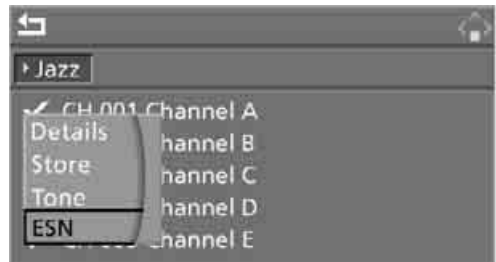

2. Select "ESN" and press the controller.
The electronic serial number, ESN, is displayed.

 The electronic serial number is required for disabling. ◀

3. To disable the channel:
Dial the phone number.

Selecting and storing a channel

1. Select "SAT" and press the controller.

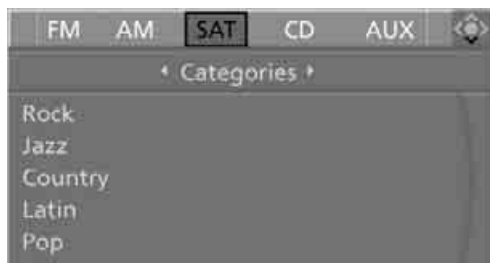

Channels and categories are displayed on the Control Display.

2. Select a menu item:
 - ▷ "Presets":
Up to twelve channels you stored previously.
 - ▷ "All channels":
All channels are displayed.
 - ▷ "Categories":
All channels, sorted by category, e.g. news, jazz.

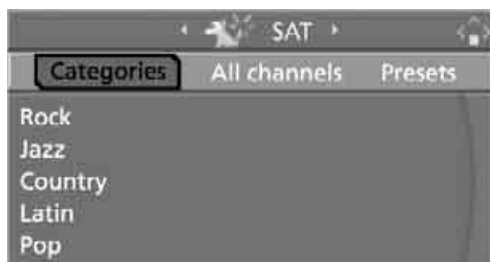

3. Press the controller.

4. If "Categories" has been selected:
Select the desired category and press the controller.

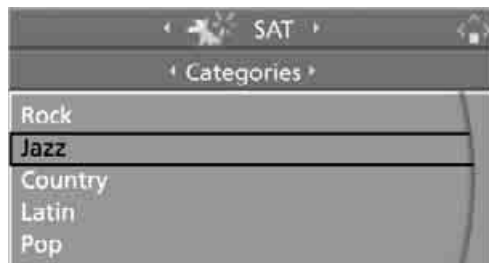

The channels of this category are displayed.

5. ✓ Select a channel marked with this symbol.

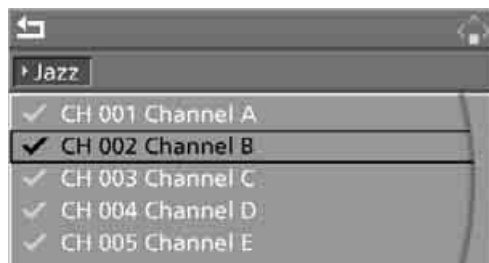

6. Press the controller.
Other menu items are displayed.
7. Select "Details" and press the controller.

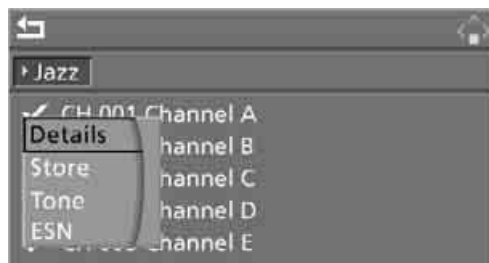

Additional information

The name of the channel and additional information on the current track are displayed, e.g. the name of the artist.

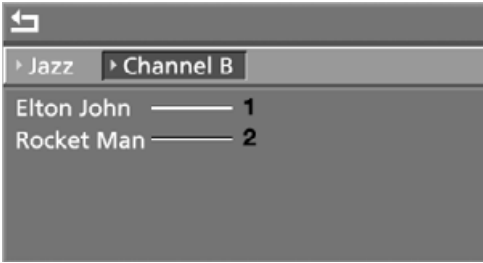

- 1 Artist
- 2 Track

Storing a channel

1. Select the desired channel.
2. Press the controller. Other menu items are displayed.
3. Select "Store" and press the controller.

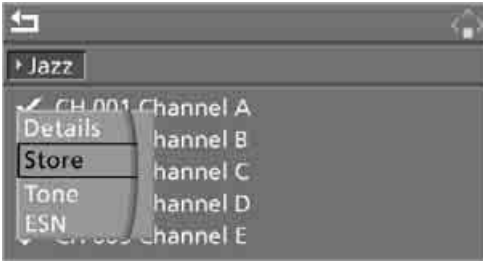

"Presets" is displayed.

4. Turn the controller to select a memory location and press the controller.



The channel is stored. The channels of the last selection criterion are displayed again after a short time.

Changing channels with buttons on CD player

Press the button for the corresponding direction. The system switches to the next enabled channel.

Notes

When more than 4 seconds go by and no signal is received, a message appears on the Control Display.

Under some circumstances, e.g. depending on environmental or topographic conditions, it may not be possible to receive any signal. The satellite radio cannot influence this. A signal may not be available in tunnels or underground garages, next to high-rise buildings, in the vicinity of trees, mountains or other strong sources of radio interference. Reception usually resumes as soon as the signal becomes available again.

CD player and CD changer*

Listening to CDs



Compressed audio files*

CDs with compressed audio files, MP3s, can be played by the CD player and CD changer.

Starting the CD player

The upper drive is for audio CDs.

Insert the CD into the drive with the labeled side up.

The CD is pulled in automatically. Playback starts automatically if the sound output is on. When playing CDs with compressed audio files, it can take the CD player approx. 1 minute to read in the data, depending on the directory structure.

To start playback when there is already a CD in the drive:

iDrive, for operating principle refer to page 16.

1. Press the **MENU** button.
This opens the start menu.
2. Move the controller backwards to call up "Entertainment".

3. If necessary, move the highlight marker to the uppermost field. Select "CD" and press the controller.



4. If necessary, move the highlight marker to the second field from the top. On cars with a CD changer, select "CD" and press the controller to start the CD player.



Playback starts automatically if the sound output is switched on.

Via programmable memory keys

You can store the CD player function on the programmable memory keys to start the CD player, refer to page 21.

Starting the CD changer

Fill and insert the CD magazine, refer to page 179.

1. Press the **MENU** button.
This opens the start menu.
2. Move the controller backwards to call up "Entertainment".

3. If necessary, move the highlight marker to the uppermost field. Select "CD" and press the controller.
4. If necessary, move the highlight marker to the second field from the top. Select the desired CD and press the controller.



At the end of the last track, the next CD is selected and played.

If new CDs have been placed in the CD magazine, playback starts with the lowest CD, e.g. CD 1, track 1.

The CD magazine's load status is indicated on the Control Display.

Via programmable memory keys

You can store a CD compartment of the CD changer on the programmable memory keys to start the CD changer, refer to page 21.

Selecting a track

Buttons on the CD player

 Press the button for the appropriate direction as often as necessary until the desired track is reached.

The track is displayed on the Control Display. You can also change the track with the buttons on the steering wheel, refer to page 11.

Via iDrive

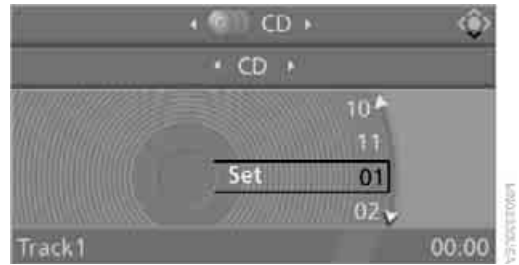

Turn the controller to select a track.

Compressed audio files*

1. Select a directory, if necessary, and press the controller.

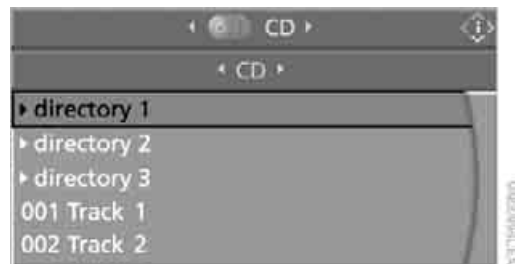

2. Select a track and press the controller.

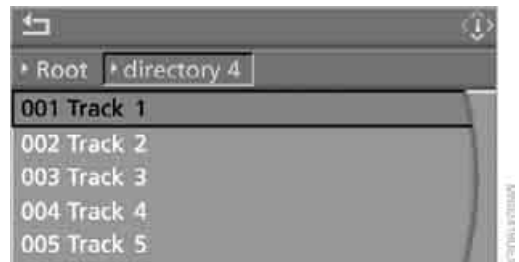

To change the directory:
Select the directory and press the controller.

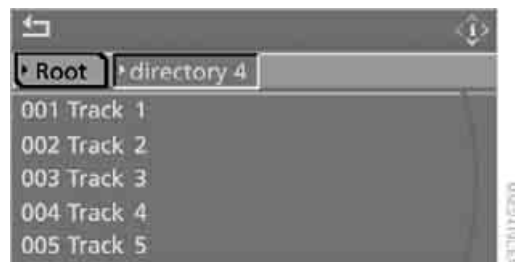

To exit from the menu:

Select the  arrow and press the controller.

If the car is equipped with two CD drives, you can save specific tracks on the programmable memory keys, refer to page 21.

Displaying information about the track*

With compressed audio files, any information about the current track that has been recorded can be displayed, e.g. the name of the artist.

1. Press the controller.
2. Select "Details" and press the controller.

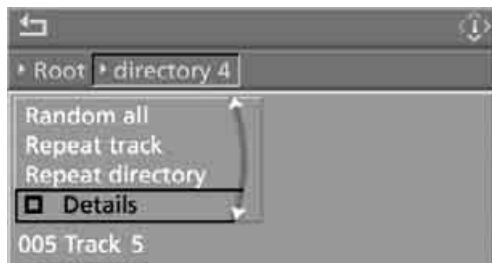

The information is shown for the current track.

The setting is stored for the remote control currently in use.

Sampling tracks, Scan

All tracks on the current CD are automatically sampled once in succession.

1. Select "Set" and press the controller.
Other menu items are displayed.



2. Select "Scan" and press the controller.



Stop sampling:

1. Press the controller.
2. Select "Scan" and press the controller.

Track sampling is interrupted and the selected track is played on.

Compressed audio files*

1. Select the current track and press the controller.
2. Select the desired menu item:
 - ▷ To sample all the tracks in the current directory, select "Scan directory" and press the controller.
 - ▷ To sample all the tracks on the CD, select "Scan all" and press the controller.

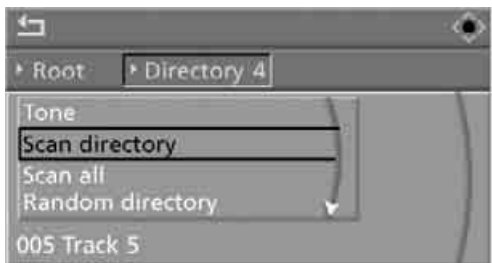

Stop sampling:

1. Press the controller.
2. Select "Scan directory" or "Scan all" and press the controller.

Sampling is interrupted and the selected track is retained.

Repeating tracks

1. Select "Set" and press the controller. Other menu items are displayed.



2. Select "Repeat" and press the controller.



The current track on the CD is repeated.

Stop repeating:

1. Press the controller again.
2. Select "Repeat" and press the controller.

Compressed audio files*

1. Select the current track and press the controller.
2. Select the desired menu item:
 - ▷ To repeat the selected track, select "Repeat track" and press the controller.
 - ▷ To repeat all the tracks in the current directory, select "Repeat directory" and press the controller.

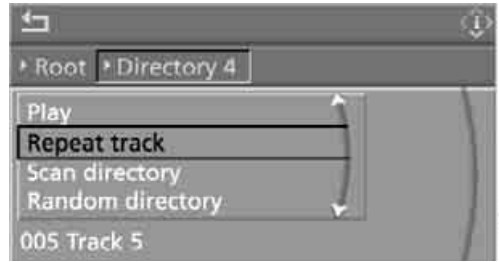

Stop repeating:

1. Press the controller.
2. Select "Repeat track" or "Repeat directory" and press the controller.

Random play sequence

The tracks on the current CD are played once each in random order.

1. Select "Set" and press the controller. Other menu items are displayed.
2. Select "Random" and press the controller.

Stop random function:

1. Press the controller.
2. Select "Random" and press the controller.

Compressed audio files*

1. Select the current track and press the controller.
2. Select the desired menu item:
 - ▷ To play all the tracks in the current directory in random order, select "Random directory" and press the controller.
 - ▷ To play all the tracks on the CD in random order, select "Random all" and press the controller.

Stop random function:

1. Press the controller.
2. Select "Random directory" or "Random all" and press the controller.

Fast forward/reverse

Buttons on the CD player:

 Press and hold the button for the corresponding direction.

The tracks can be heard, but reproduction is distorted.

CD magazine



The BMW CD changer for six CDs is behind the left side panel in the cargo bay.

Removing the CD magazine

To insert or remove CDs from the CD magazine, you must first remove it from the CD changer:



1. Push the cover to one side, arrow 1.
2. Press the button, arrow 2.
The CD magazine is ejected.

Inserting/removing CDs from the CD magazine



When loading CDs into or removing them from the CD magazine, hold them at their edges and do not touch the reflective signal-sensing area.

Inserting CDs:

Insert the CD in its slot with the label side on top.

Removing CDs:

Pull out the desired drawer, see arrow, and remove the CD.

Inserting the CD magazine

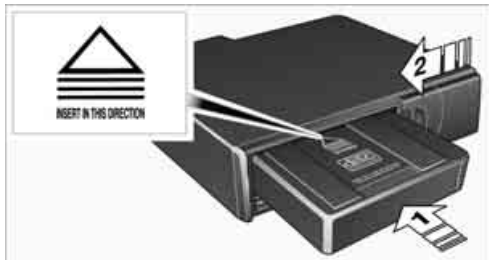

Insert the CD magazine all the way in the direction of arrow **1** and close the cover, arrow **2**.

The CD changer automatically reads in the loaded CDs and is then ready for operation.

Notes

⚠ BMW CD/DVD players and changers are officially designated Class 1 laser products. Do not operate if the cover is damaged, otherwise severe eye damage can result. Do not use self-recorded CDs/DVDs with labels applied as these can become detached during playback due to heat build-up and can cause irreparable damage to the device. Only use round CDs/DVDs with a standard diameter of 4.7 in/12 cm and do not play CDs/DVDs with an adapter, e.g. Single-CDs, otherwise the CDs or the adapter can jam and will no longer eject. Do not use a combined CD/DVD, e.g. DVD^{Plus}, otherwise the CD/DVD can jam and will no longer eject. ◀

General malfunctions

BMW CD/DVD changers and players have been optimized for performance in vehicles. In some instances they may be more sensitive to faulty CDs/DVDs than stationary devices would be.

If a CD/DVD cannot be played, first check if it has been inserted correctly.

Humidity

High levels of humidity can lead to condensation on the CD/DVD or the laser's scan lens and temporarily prevent playback.

Malfunctions with individual CDs/DVDs

If malfunctions only occur with individual CDs/DVDs, one of the following factors may be the cause.

Self-recorded CDs/DVDs

Possible reasons for malfunctions with self-recorded CDs/DVDs are, e.g., inconsistent data-creation or recording processes, or poor quality or high age of the CD/DVD blank.

Only label CDs/DVDs on the top, with a pen designed for this purpose.

Damage prevention

Avoid leaving fingerprints, as well as dust, scratches or moisture on the CDs/DVDs. Keep CDs/DVDs in protective sleeves or cases. Do not subject CDs/DVDs to temperatures over 120 °F /50 °C, high levels of humidity or direct sunlight.

CDs/DVDs with copy protection

CDs/DVDs are often copy-protected by the manufacturer. This can mean that some CDs/DVDs cannot be played or can only be played to a limited extent.

Care

Clean the reflective signal side of CDs/DVDs as needed by wiping it with a commercially available cleaning tissue in straight lines from the center of the disc outwards.

AUX-In port

You can connect an external audio device, for instance an MP3 player, and play audio tracks over the car's loudspeaker system. You can adjust the tone using iDrive.

Connecting

Lift up the center armrest.



Connection for audio playback:
TRS connector 1/8 in/3.5 mm

To play audio tracks over the car's loudspeaker system, connect the headset or line-out port of the external device to the AUX-in port.

Starting audio playback

The audio device must be switched on.

iDrive, for operating principle refer to page 16.

1. Press the **MENU** button.
This opens the start menu.
2. Move the controller backwards to call up "Entertainment".
3. If necessary, move the highlight marker to the uppermost field. Turn the controller

until "AUX" is selected and press the controller.



4. Select "AUX IN" and press the controller.
5. Adjust volume and tone, if necessary.

Via programmable memory keys

You can store the "AUX" function on the programmable memory keys to start audio playback, refer to page 21.

USB-audio interface*

You can connect audio devices, e.g. an iPod or a USB device (MP3 player, USB stick), to the USB-audio interface. They can be operated via iDrive.

Standard audio formats, e.g. MP3, WMA, WAV (PCM) and AAC, and playlists in the M3U format can be played.

Due the variety of audio devices on the market, it cannot be guaranteed that every device will be operable on the vehicle.

Ask your BMW center about what audio devices are suitable.

Connecting

Lift up the center armrest.



1 Connection for audio playback:
TRS connector 1/8 in/3.5 mm

2 USB interface

 Depending on your vehicle's equipment version, it may contain a storage pouch for your audio device. The pouch is located under the center armrest. ◀

iPod

To connect the iPod use the BMW cable adapter for Apple iPod. For more information, contact your BMW center or go to the Internet: www.bmw.com

To play audio tracks over the vehicle's loud-speaker system, connect the iPod to ports **1** and **2**.

The iPod's menu structure is supported by the USB-audio interface.

USB device

 To connect the device, use the included flexible adapter cable to protect the USB interface and your USB device against physical damage. ◀

To play audio tracks over the vehicle's loud-speaker system, connect the USB device to port **2**.

After the device is connected for the first time, the information on all tracks (e.g. artist, type of music) and the playlists are transferred from the USB device to the vehicle. This procedure may take some time. The duration depends on the USB device and the number of tracks.

During transfer, you can select the tracks using the directories and file names.

After transfer, you can call up the tracks using the information and playlists.

Information from up to four USB devices or for about 20,000 tracks can be stored on the vehicle.

If a fifth USB device is connected and if more than 20,000 tracks are to be stored, the information on existing tracks may be lost.

 Music tracks with integrated Digital Rights Management (DRM) cannot be played. ◀

Starting audio playback

Via iDrive

If the audio device has a device name, the name is displayed.

1. Press the **MENU** button.
This opens the start menu.
2. Move the controller backwards to call up "Entertainment".

3. If necessary, move the highlight marker to the uppermost field. Turn the controller until "AUX" is selected and press the controller.



4. Select "USB" or the name of the audio device and press the controller.



Playback begins with the first track.

Via programmable memory keys

You can store the "USB" function on the programmable memory keys to start audio playback, refer to page 21.

Selecting a track

You can call up the tracks using the playlists and information. With USB devices you can also call up tracks using the file directory. The tracks can be displayed if they have been stored in the Latin alphabet.

1. Make your selection, e.g. "Playlists" or "Artists", and press the controller.



2. Select a track and press the controller.

Displaying information about the track

Any information about the current track that has been recorded can be displayed, e.g. the name of the artist.

1. Press the controller during playback.
2. Select "Details" and press the controller.

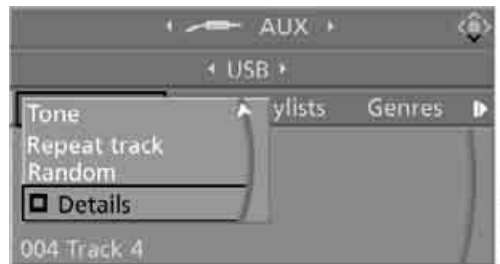

The information is shown for the current track.

Repeating tracks

1. Select the current track and press the controller.
2. Select "Repeat track" and press the controller.

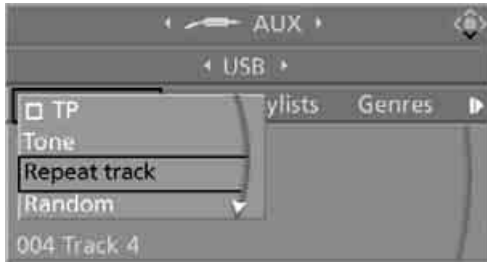

Stop repeating:

1. Press the controller.
2. Select "Repeat track" and press the controller.

Random play sequence

You can play the tracks in the selected list in random order, e.g. all tracks of a single artist.

1. Select the current track and press the controller.
2. Select "Random" and press the controller.

Stop random play:

1. Press the controller.
2. Select "Random" and press the controller.

Fast forward/reverse

Buttons on the steering wheel or CD player:

 Press and hold the button for the corresponding direction.

Notes

 Do not expose the audio device to extreme environmental conditions, e.g. very high temperatures, refer to the operating instructions of the audio device. Otherwise the

audio device may become damaged, which could compromise safety while driving. ◀

Depending on the configuration of the audio files, e.g. bit rates greater than 256 KBit/s, the files may not play back correctly in every case.

Notes on connecting

- ▷ The USB-audio interface acts as the power supply to the connected audio devices, provided that this is supported by the audio device. Therefore, do not connect the USB audio device to the power socket in the vehicle during operation.
- ▷ Do not forcibly connect the plug to the USB interface.
- ▷ Do not connect devices such as fans or lamps to the USB-audio interface.
- ▷ Do not connect USB hard disks.
- ▷ Do not use the USB-audio interface to charge external devices.



Communications

This chapter describes how to use the telephone, BMW Assist and BMW TeleServices.

Telephoning*

The concept

Your BMW is equipped with a full mobile phone preparation package. After pairing a suitable mobile phone with the vehicle once, you can operate the mobile phone via iDrive, the buttons on the steering wheel or via voice commands.

Once a mobile phone has been paired with your vehicle, it is automatically recognized as soon as it is inside the vehicle while the engine is running or the ignition is switched on. You can store the pairing data for up to four mobile phones simultaneously. If several mobile phones are detected at the same time, the mobile phone last paired can be operated via the vehicle.

Using the telephone inside the vehicle

Using the snap-in adapter*

The so-called snap-in adapter, a holder for mobile phones, allows you to charge the mobile phone's battery and connect the mobile phone to your vehicle's outside antenna. This ensures better network reception and consistent reproduction quality. Please contact your BMW center to find out for which mobile phones there are snap-in adapters available.

For your safety

A car phone makes life more convenient in many ways, and can even save lives in an emergency. While you should consult your mobile phone's separate Owner's Manual for a detailed description of safety precautions and information, we request that you direct your particular attention to the following:



Only make entries when the traffic situation allows you to do so. Do not hold the mobile phone in your hand while you are driving; use the hands-free system instead. If you do not observe this precaution, your being dis-

tracted can endanger vehicle occupants and other road users. ◀

Suitable mobile phones

Please ask your BMW center which mobile phones with Bluetooth interface are supported by the mobile phone preparation package and which mobile phones are compatible with the snap-in adapter. By virtue of their particular software versions, these mobile phones support the functions described in this Owner's Manual. Malfunctions may occur with other mobile phones.

Care instructions

Important information on this subject can be found in the separate mobile phone Owner's Manual.

Operating options

You can operate the mobile phone* using:

- ▷ Buttons on the steering wheel, refer to page 10
- ▷ iDrive, refer to page 193
- ▷ Voice commands, refer to page 199
- ▷ Programmable memory keys, refer to page 21

Avoid operating a mobile phone recognized by the vehicle via the mobile phone's keypad, otherwise malfunctions may result.

Making phone calls with the BMW Assist system*: BMW Assist calls

You can use the BMW Assist System via the hands-free unit for BMW Assist calls.

When the status information "BMW Assist" or "BMW Service" is displayed in "Communication", only BMW Assist calls are possible.

It may not be possible to establish a telephone connection using the mobile phone while a connection is being established to BMW Assist or while a call to BMW Assist is already in progress. If this happens, you must unpair the mobile phone and the vehicle if you wish to place a call with the mobile phone.

Start-up

Pairing the mobile phone with the vehicle

The following prerequisites must be met:

- ▶ Compatible mobile phone: the mobile phone is supported by the full preparation package mobile phone. You can obtain information on the Internet at: www.bmw.com
- ▶ The mobile phone is ready to operate.
- ▶ The Bluetooth link is activated in the vehicle, refer to page 193, and in the mobile phone.
- ▶ Depending on the mobile phone, some default settings may be necessary for the mobile phone: e.g. using the following menu items:
 - ▶ Bluetooth switched on
 - ▶ Connection without confirmation
 - ▶ Reconnection
- ▶ Depending on the mobile phone type, the power-saving mode setting, for example, may result in a paired mobile phone not being detected by the vehicle.
- ▶ For pairing purposes, define any number as the Bluetooth passkey, e.g. 1. This Bluetooth passkey is no longer required after pairing has been successful.
- ▶ The ignition is switched on.

 Pair the mobile phone with the vehicle only when the car is stationary, to avoid

endangering the car's occupants and other road users by being distracted. ◀

Switch on ignition

1. Insert remote control all the way into the ignition lock.
2. Switch on ignition without operating the brake or clutch or pressing the start/stop button.

Preparation via iDrive

iDrive, for operating principle refer to page 16.

3. Press the **MENU** button to call up the start menu.



4. Press the controller to open the **i** menu.
5. Select "Settings" and press the controller.



6. Select "Bluetooth" and press the controller.



- Move the highlight marker to the second field from the top, select "Phone" and press the controller.



- Select "Pair new phone" and press the controller.



- Select "Start pairing" and press the controller.



The Bluetooth name of the vehicle is displayed.

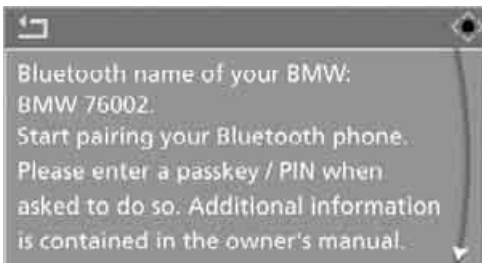

Preparation via the mobile phone

- Further steps must be carried out with the mobile phone and vary depending on the model. Please refer to your mobile phone's operating instructions, e.g. under the topics of Searching for a Bluetooth device, Linking or Pairing. The Bluetooth name of the vehicle also appears on the mobile phone display.
- Select the Bluetooth name of the vehicle on the mobile phone display.

Pairing

Depending on your mobile phone, you will see messages, first on the mobile phone display or on the iDrive, requesting you to enter the same Bluetooth passkey previously determined by you.

- Enter the Bluetooth passkey. Depending on the mobile phone, you will have approx. 30 seconds to enter your Bluetooth passkey on the mobile phone and the Control Display.

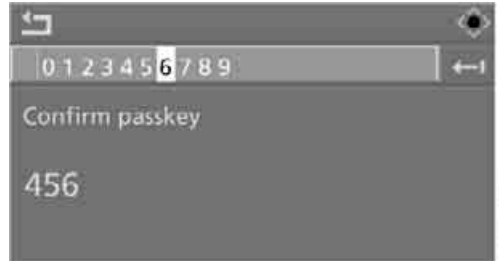

- Move the highlight marker to the third field from the top, select "Confirm passkey" and press the controller.
- Wait several seconds until the "Communication" menu is displayed.

The next time you use the mobile phone inside the vehicle, it will be recognized within no more than 2 minutes as long as the engine is running or the ignition is switched on.

- ▶ With some mobile phones it may be necessary to make certain settings for a permanent Bluetooth link, e.g. using the authorization or secure connection menu item, refer to your mobile phone's operating instructions. ◀

As soon as a mobile phone is detected by the vehicle, the phone book entries stored on the SIM card or on your mobile phone are transmitted to the vehicle. This data transfer depends on your mobile phone and can take several minutes; please refer to your mobile phone's operating instructions, if necessary.

If not all phone book entries are displayed:

- ▶ Transfer all phone book entries from the SIM card to the mobile phone, if necessary.
- ▶ Phone book entries with special characters may not be displayed.

Up to four mobile phones can be paired, one after the other. If a fifth mobile phone is paired, the pairing data for the mobile phone whose pairing data was first stored on the vehicle is deleted.

Checks to perform if pairing is unsuccessful

- ▶ Is the mobile phone supported by the mobile phone preparation package? You can obtain information on the Internet at: www.bmw.com.
- ▶ Do the Bluetooth passkeys on the mobile phone and vehicle match? The same Bluetooth passkey must be entered on the mobile phone's display and via iDrive.
- ▶ Did it take you more than 30 seconds to enter the Bluetooth passkey?
- ▶ Only a limited number of devices can be connected with the mobile phone. If necessary, delete connections with other devices.
- ▶ Is the mobile phone no longer responding? Switch the mobile phone off and on or briefly disconnect the power supply.

To repeat pairing:

1. Select "Restart pairing" and press the controller.

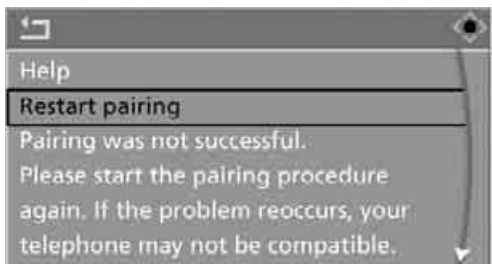

2. Repeat steps 9 to 14.

If pairing fails again, contact BMW Customer Relations.

To call BMW Customer Relations:
Select "Help" and press the controller.

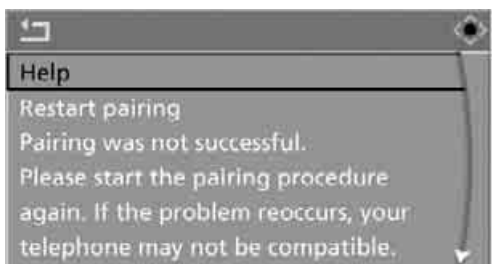

The phone number for BMW Customer Relations and information necessary for pairing appear on the display. In mobile phones that are already connected, you can select the BMW Customer Relations phone number to place the call.



List of paired mobile phones

Mobile phones with pairing data stored by the vehicle can be displayed. If several mobile phones are detected by the vehicle at the same

time, the mobile phone at the top of the list can be operated via the vehicle.

You can change the order of the mobile phones on the list. As long as a mobile phone from this list is selected, you cannot operate the mobile phones via the vehicle.

iDrive, for operating principle refer to page 16.

1. Press the **MENU** button to call up the start menu.
2. Press the controller to open the **i** menu.
3. Select "Settings" and press the controller.
4. Select "Bluetooth" and press the controller.
5. Move the highlight marker to the second field from the top, select "Phone" and press the controller.
6. Select the desired mobile phone and press the controller.



7. Select "Move device up" and press the controller.



The selected mobile phone moves up one position on the list.

Unpairing the mobile phone from the vehicle

Should you no longer wish to operate a mobile phone via the vehicle, you can delete the mobile phone's pairing data.

iDrive, for operating principle refer to page 16.

1. Switch off the mobile phone.
2. Press the **MENU** button to call up the start menu.
3. Press the controller to open the **i** menu.
4. Select "Settings" and press the controller.
5. Select "Bluetooth" and press the controller. "Bluetooth" is selected.
6. Move the highlight marker to the second field from the top, select "Phone" and press the controller.
7. Select the desired mobile phone and press the controller.



8. Select "Delete device" and press the controller.

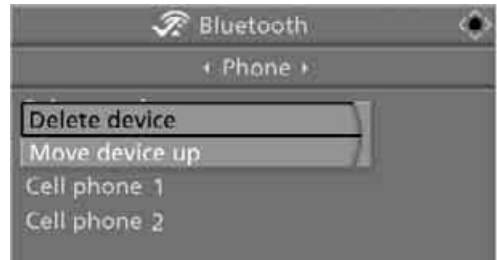

The unpaired mobile phone is deleted from the list.

The phone book entries and the lists of stored phone numbers are deleted as well.

Activating/deactivating the Bluetooth link

 The use of Bluetooth technology is not permitted in all countries. Observe all applicable local regulations. Temporarily deactivate the Bluetooth link between the vehicle and the mobile phone, if necessary. If the Bluetooth link is deactivated, you can no longer operate the mobile phone via the vehicle, and other devices with a Bluetooth interface can be used in combination with the mobile phone, e.g. a laptop. ◀

To temporarily deactivate the Bluetooth link between the vehicle and your mobile phone:

1. Press the **MENU** button to call up the start menu.
2. Press the controller to open the **i** menu.
3. Select "Settings" and press the controller.
4. Select "Bluetooth" and press the controller.



5. Move the highlight marker to the second field from the top, select "Settings" and press the controller.



6. Select "Bluetooth communication active" and press the controller to activate or deactivate the link.

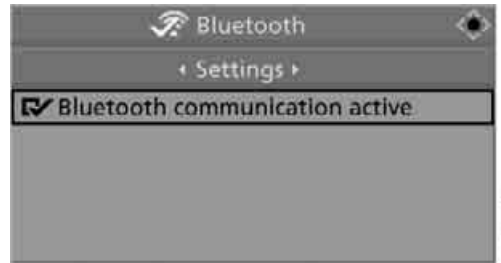

- The Bluetooth link is activated.
- The Bluetooth link is deactivated.

Adjusting volume

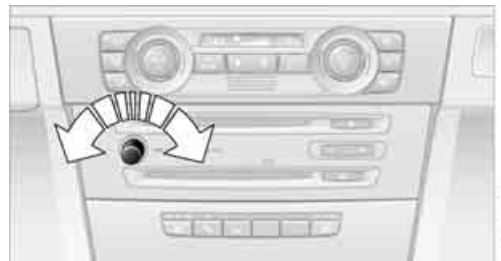

Turn the knob during a call to select the desired volume.

This volume for the hands-free system is maintained, even if the other audio sources are set to minimum volume.

You can also adjust the volume with buttons on the steering wheel, refer to page 10.

The setting is stored for the remote control currently in use.

Operation via iDrive

You can operate the following functions using iDrive:

- ▷ Accepting/rejecting calls
- ▷ Dialing phone numbers
- ▷ Selecting phone numbers from the phone book

- ▷ Selecting stored phone numbers, e.g. from the list of accepted calls
- ▷ Ending a call

When the ignition and radio readiness are switched off, e.g. after taking the remote control out of the ignition switch, you can continue an ongoing call via the hands-free system for no more than 25 minutes.

Voice quality

If the person you are talking to is having difficulties understanding you, this may be due to excessive background noise. The full mobile phone preparation package can compensate for these noises to a certain extent. To optimize voice quality during a call, we recommend that you:

- ▷ Reduce background noise, e.g. by closing the windows, reducing air flow from the automatic climate control or by pointing the open front air vents downward
- ▷ Reduce the volume of the hands-free system

Requirements

- ▷ The mobile phone's pairing data are stored by the vehicle and the mobile phone is operational.
- ▷ The engine is running or the ignition is switched on.
- ▷ The mobile phone is recognized by the vehicle.

Calling up communication

Many of the functions described below are controlled using the "Communication" menu.

iDrive, for operating principle refer to page 16.

1. Press the **MENU** button to call up the start menu.



2. Move the controller forwards to call up "Communication".

Receiving calls

If you have the phone number of the caller stored in the phone book and the phone number has been transmitted, the name of the entry is displayed.

Accepting a call

Press the  button on the steering wheel.

Alternatively:

"Accept" is selected.

Press the controller.

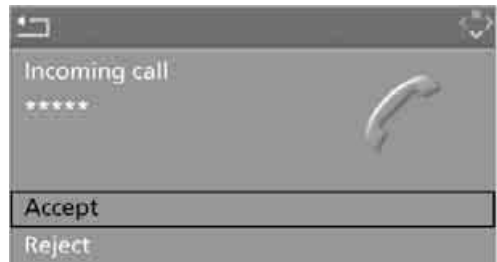

Rejecting a call

Select "Reject" and press the controller.

The caller is diverted to your mailbox if it has been activated.

Calling

Dialing phone numbers

1. Select "Phone" and press the controller.



2. Select "Dial" and press the controller.
3. Enter the desired phone number by selecting the digits individually and pressing the controller.

Always enter the complete phone number consisting of national dialing code, area code, and phone number. The letters correspond to the numbers on the keypad of the mobile phone.

To delete the last digit:

Move the controller towards the right to select the arrow  and press the controller.

4. Select "Dial number" and press the controller.

Alternatively: press the  button on the steering wheel.



For your phone number to be displayed to the person you are talking to, the display of phone numbers must be enabled by your provider.

Via programmable memory keys

You can store phone numbers on the programmable memory keys to call these numbers directly, refer to page 21.

Ending a call

Press the  button on the steering wheel.

Alternatively:

1. Select the phone number and press the controller.



2. "End call" is selected. Press the controller.



Selecting a phone number from the phone book or from a list of stored phone numbers

Phone numbers you have dialed, received calls and phone book entries are stored in lists when the mobile phone is linked to the vehicle via Bluetooth. If the caller is listed in the phone book, the name of the entry is displayed instead of the phone number.

You can select the desired subscriber from the list and establish the connection.

Five lists are available:

- ▷ "A - Z"
The entries in your mobile phone's phone

book, consisting of names and phone numbers, are sorted alphabetically.

- ▷ "Top 8"
The eight numbers dialed most frequently from the "A - Z" phone book are automatically stored in the Top 8 list.
- ▷ "Redial"
The last eight phone numbers you have dialed are automatically stored. The last number dialed is at the top of the list.
- ▷ "Missed calls"
The phone numbers of the last eight rejected calls are stored. This requires the telephone number of the caller to have been transmitted.
- ▷ "Received calls"
The phone numbers of the last eight accepted calls are stored. This requires the telephone number of the caller to have been transmitted.

Selecting phone numbers from phone book

The "A - Z" list is available for your phone book entries. The phone book entries appear on the Control Display.

1. Select "Phone" and press the controller.



2. Select "A - Z" and press the controller.
3. To limit the number of displayed entries, select the initial letter of the desired entry and press the controller.

4. Select the desired entry and press the controller.



5. Select "Call" and press the controller.
The system dials the number.

If different phone numbers are stored in the mobile phone under one name, e.g. office and home, the name is shown once for each phone number.

You can change a phone number stored in the phone book, e.g. to call a specific extension:

1. Select "Phone" and press the controller.
2. Select "A - Z" and press the controller.
3. Select the desired entry and press the controller.
4. Select "Add digits" and press the controller.
5. Change the phone number.
6. Select "Dial number" and press the controller.

Dialing a stored phone number from a list

To select an entry and establish a connection:

1. Select "Phone" and press the controller.
2. Select a list and press the controller:
 - ▷ "Top 8"
 - ▷ "Redial"
 - ▷ "Missed calls"
 - ▷ "Received calls"



3. Select the desired entry and press the controller.



4. Select "Call" and press the controller. The system dials the number.

Deleting an individual entry

1. Select the desired entry from the list and press the controller.
2. Select "Delete" and press the controller. The entry is deleted.



Deleting the entire list

1. Select an entry from the list and press the controller.
2. Select "Delete all numbers" and press the controller.



3. If applicable, select "Yes" and press the controller. The list is deleted.

BMW Contact*

If BMW Assist has not been enabled for you, you can have several service numbers displayed:

- ▷ BMW Roadside Assistance* if you need help in the event of a breakdown
- ▷ BMW Service if you wish to schedule a service appointment, for example
- ▷ BMW Customer Relations* for information related to your vehicle

If BMW Assist is enabled, refer to page 203.

You can dial the displayed service numbers if your mobile phone has been paired with the vehicle:

iDrive, for operating principle refer to page 16.

1. Press the **MENU** button. This opens the start menu.
2. Move the controller forwards to select "Communication".

3. Select "BMW Contact" and press the controller.



4. Select "BMW Contact Numbers" and press the controller.



5. Select one of the following menu items and press the controller:
 - ▷ "Roadside Assistance"
 - ▷ "Customer Relations"
 - ▷ "Service Request"
6. Select "Call" and press the controller. Contact will be established.

Dialing phone numbers via touch tones

Touch-tone dialing is required for access to network services or for controlling devices, e.g. for remote querying on an answering machine. This function is available whenever there is a connection.

1. Establish connection.



2. Move the controller backwards until the bottom field is selected.
3. Select the desired touch-tone character and press the controller. Each selection is transmitted immediately and is confirmed by a tone, depending on the type of mobile phone you are using.



Switching between mobile phone and hands-free system

From mobile phone to hands-free system*

You can continue ongoing calls outside of the vehicle's Bluetooth range via the hands-free system as long as the engine is running or the ignition is switched on. Depending on your mobile phone, the system automatically switches to hands-free mode.

With mobile phones that do not automatically switch to hands-free mode:

- ▷ Depending on the type of mobile phone you are using, it may be possible to continue the conversation via the hands-free system. Refer to the display on your mobile phone

and/or your mobile phone's operating instructions.

- ▶ Press the  button above the storage compartment.

From hands-free system to mobile phone

If you are making a call via the hands-free system, it may be possible to continue the call via the mobile phone, depending on your mobile phone model. Refer to the display on your mobile phone and/or your mobile phone's operating instructions.

Alternatively, you can deactivate the Bluetooth link.

Depending on the type of mobile phone you are using, it may occur that calls are switched from the hands-free system to the mobile phone if reception of the wireless network is poor.



Operation by voice commands*

The concept

You can operate your mobile phone without having to take a hand off the steering wheel. During your entries, you will be guided in many cases by announcements or questions.

The same prerequisites apply as for operation via iDrive, refer to page 193.

Symbols in the Owner's Manual

-  ›...‹ Say the specified commands word for word.
-  ››...‹‹ Indicates responses of the system.

Saying commands

Activating the system

1. Briefly press the  button on the steering wheel.
A sound signal indicates that you can say commands.
2. Say the command.

Ending/canceling operation by voice commands

Press the  button on the steering wheel or

 ›Cancel‹.

In dialogs where text is spoken, e.g. a name rather than a command, canceling is only possible using the button on the steering wheel.

Having the possible commands read aloud

The system recognizes specific commands that must be pronounced exactly word for word. You can have the possible commands for any function read aloud to you:

 ›Help‹

Using alternative commands

Often there is more than a single command to run a function, e.g.:

 ›Dial name‹ or ›Name‹.

Digits from zero to nine are recognized.

You can say each digit individually or group them into a sequence to accelerate the input.

Example: dialing phone numbers

Start the dialog:

Press the  button on the steering wheel.

Command	Voice control response
›Dial number‹ e.g. ›123 456 7890‹	››Please say the number‹‹ Depending on your equipment version: ››123 456 7890. Continue?‹‹ or ››123 456 7890. And next?‹‹
›Dial‹	››Dialing number‹‹

Adjusting the volume of the instructions

You can adjust the volume for the instructions from the system:

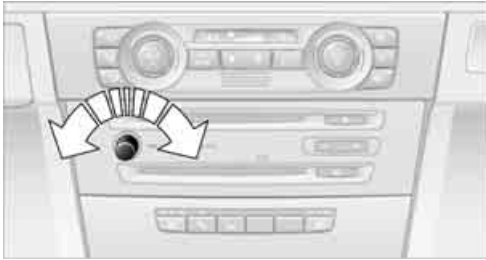

Turn the button during an instruction.

This volume for the instructions is maintained, even if the other audio sources are set to minimum volume.

The setting is stored for the remote control currently in use.

Calling

Dialing phone numbers

1. ›Dial number‹.
2. Say the phone number.
For telephone calls abroad, say ›Plus‹ and then the country code.
3. ›Dial‹.

The connection to the desired subscriber is established.

Correcting phone numbers

After the last spoken sequence of digits has been repeated by the system, you can delete this sequence of digits.

-  ›Correct number‹.
The digits are deleted.

The command ›Correct number‹ can be repeated as often as you like.

Deleting phone numbers

-  ›Delete‹.

All digits entered up to this point are deleted.

Voice phone book

The phone book entries can be called up automatically from your mobile phone's memory.

Selecting an entry

The connection to the phone number of the selected entry is established.

1. ›Dial name‹.
The dialog for selecting an entry is opened.
2. Say the name when prompted.
3. Confirm the prompt with ›Yes‹.

Redialing

The ›Redial‹ command calls up "Redial".

Notes

Important for voice commands

For voice commands, bear in mind the following:

- ▷ Pronounce the commands smoothly and at normal volume, avoiding excessive emphases and pauses.
- ▷ Keep the doors, windows and glass roof closed to prevent interference from outside noise.
- ▷ Avoid ambient noise in the vehicle while speaking.

Inserting/removing snap-in adapter*

1. Press area **1** around the button and take off the cover*.

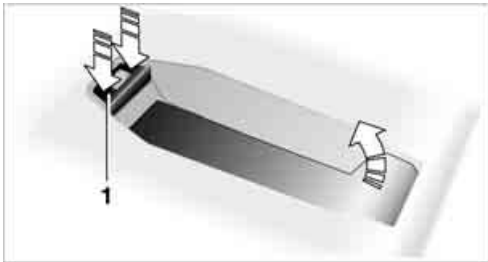

2. Insert the snap-in adapter in the front and press it downward until it engages.



To remove the snap-in adapter:
Press area **1**.

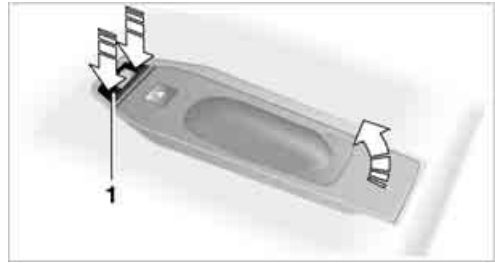

Inserting mobile phone

1. If applicable, remove the protective cap from the mobile phone's antenna connector so that the mobile phone can engage in the snap-in adapter.
2. With its buttons facing upward, slide the mobile phone up towards the electrical contact points and press it downward until it engages.

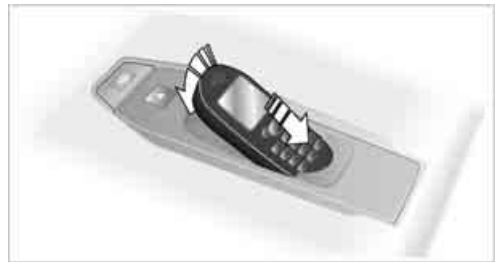

The mobile phone's battery is charged as soon as the vehicle is in radio readiness or the steering is unlocked.

- ▷ To conserve battery power, you should avoid using the mobile phone when the ignition is switched off. ◀

Removing mobile phone

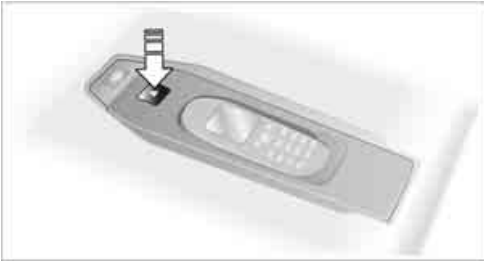

Press the button.

BMW Assist provides you with various services. For example, the position data of your vehicle can be transmitted to the BMW Assist Response Center if an Emergency Request* has been sent.

Many BMW Assist services depend on the individually agreed contract.

After your contract has expired, the BMW Assist system will be deactivated by the BMW Assist Response Center without you having to visit a BMW center. After the BMW Assist system has been deactivated, no BMW Assist service will be available. The BMW Assist system can be reactivated by a BMW center after a new contract has been signed.

Requirements

You can use BMW Assist when the following requirements are met:

- ▷ The installed BMW Assist system is logged on to a mobile phone network. This network must be capable of transmitting the services.
- ▷ To transmit position data, the vehicle must be able to determine the current position.
- ▷ To activate and update BMW Assist, a GPS signal must be available.
- ▷ You have subscribed to BMW Assist with your BMW center or with the BMW Assist Response Center. Enabling must have been completed.
- ▷ BMW Assist is activated, refer to page 208.

Offered services

The following services are available via BMW Assist:

- ▷ Emergency Request, refer to page 241: When you press the SOS button, a connection is established to the BMW Assist Response Center. The BMW Assist

Response Center contacts you and takes further steps to help you.

- ▷ Automatic Collision Notification: Under certain conditions, a connection is established to the BMW Assist Response Center after a serious accident. If possible, the BMW Assist Response Center contacts you and takes further steps to help you.
- ▷ Enhanced Roadside Assistance: You can call BMW Roadside Assistance* should you require help in the event of a breakdown. If possible, the vehicle data and position data are transmitted during this call.
- ▷ Customer Relations: For all information related to your vehicle you can be connected with BMW Customer Relations.
- ▷ BMW TeleServices*: Data on your vehicle's service status or required inspections are transmitted to your BMW center either automatically before a service due date or when you request a BMW service appointment.
- ▷ Remote Door Unlock: Contact the BMW Assist Response Center if your remote control or key is not available and you would like to have the vehicle unlocked.
- ▷ Stolen Vehicle Recovery: After you report your vehicle stolen with the police, call the BMW Assist Response Center to determine its position.

In addition, optional services can be provided to you, such as the Concierge service or information on directions, traffic or the weather. You can use Critical Calling to activate a limited number of calls via the BMW Assist Response Center, e.g. when you do not have your mobile phone with you.

Press the SOS button in order to contact the BMW Assist Response Center, see below.

You can also access the BMW Assist Concierge service via the Internet.

Characteristics of the offered services

The following characteristics apply to the services:

- ▷ The services offered are country-specific.
- ▷ Voice contact is established or data are transferred, depending on the equipment and the country. In some countries, it is possible to do both.
- ▷ The data transmitted can be vehicle data, for example, your current position or the Condition Based Service CBS data.

Using services

Contacting the BMW Assist Response Center

You can contact the BMW Assist Response Center via the SOS button.

1. Briefly press the cover flap to open. The arrangement of the switches and indicator lamps varies slightly among vehicle equipment versions.



2. Press the button for at least 2 seconds.

The BMW Assist Response Center will connect you with BMW Roadside Assistance.

Roadside Assistance

iDrive, for operating principle refer to page 16.

1. Press the **MENU** button. This opens the start menu.



2. Move the controller forwards to select "Communication".
3. If necessary, move the highlight marker to the uppermost field. Turn the controller until "BMW Assist" is selected and press the controller.

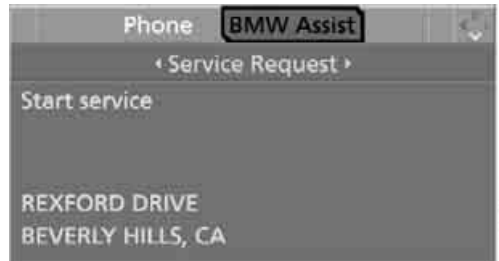

4. Select "Roadside Assistance" and press the controller.

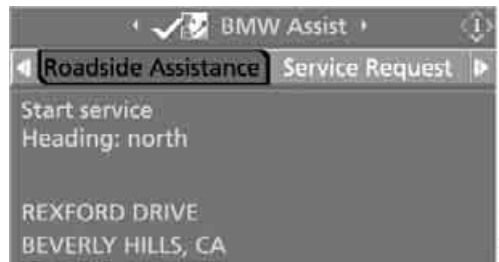

If the current location can be determined, the current vehicle position is displayed.

5. Select "Start service" and press the controller.

The BMW Assist Response Center will connect you with BMW Roadside Assistance.

BMW TeleServices*

Automatic BMW Teleservice Call*

The data on the service status of your vehicle or on required inspections are transmitted automatically prior to the due date. You can check when the BMW center was notified.

1. Press the **MENU** button.
This opens the start menu.
2. Press the controller to open the **i** menu.
3. Select "Info sources" and press the controller.



4. Select "Service Info" and press the controller.
5. If necessary, move the highlight marker to the uppermost field. Turn the controller until "Service requirements" is selected and press the controller.

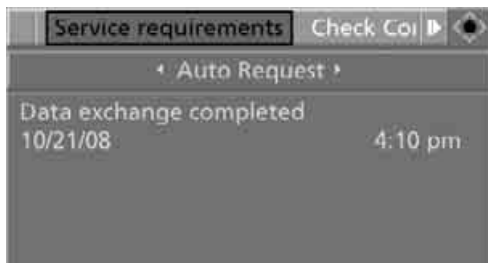

6. Select "Auto Request" and press the controller.



Manual BMW Teleservice Call

You can transmit data regarding your vehicle's service status to your BMW center when you wish to arrange a service appointment.

1. Press the **MENU** button.
This opens the start menu.
2. Move the controller forwards to select "Communication".
3. If necessary, move the highlight marker to the uppermost field. Turn the controller until "BMW Assist" is selected and press the controller.

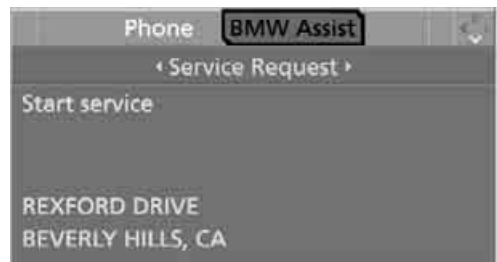

4. Select "Service Request" and press the controller.

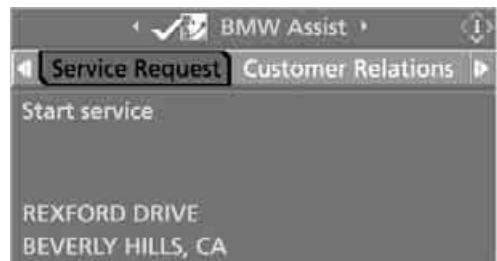

5. Select "Start service" and press the controller.

The service-relevant data are transmitted. Your BMW center will contact you to arrange a service appointment.

Displaying and updating* BMW TeleServices

1. Press the **MENU** button.
This opens the start menu.
2. Press the controller to open the **i** menu.
3. Select "Settings" and press the controller.



4. Select "BMW Service settings" and press the controller.



5. Select "Enabled TeleServices" and press the controller.



The activated BMW TeleServices are displayed.

6. Select "Options" and press the controller.
7. Select "Update services" and press the controller.

Contacting BMW Customer Relations

For all information related to your vehicle you can call BMW Customer Relations.

1. Press the **MENU** button.
This opens the start menu.
2. Move the controller forwards to select "Communication".
3. If necessary, move the highlight marker to the uppermost field. Turn the controller until "BMW Assist" is selected and press the controller.

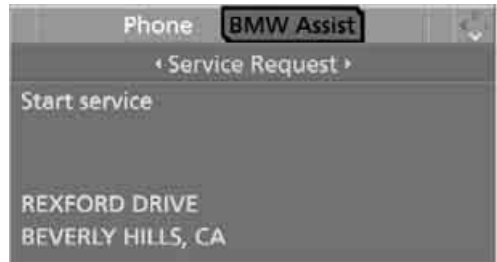

4. Select "Customer Relations".

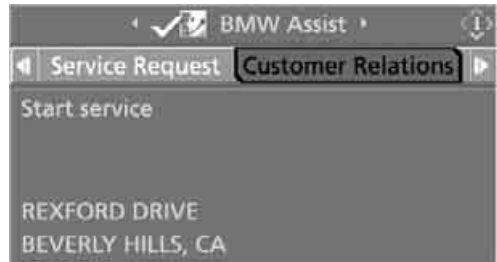

5. Press the controller.
6. Select "Start service" and press the controller.

The BMW Assist Response Center will connect you with BMW Customer Relations.

Concierge service*

When you call the BMW Assist Concierge, you can obtain information about, e.g., current events, gas stations or hotels, as well as receive the corresponding telephone numbers and addresses. Many hotels can be booked directly through the BMW Assist Concierge service.

Concierge service requires additional enabling by the BMW Assist Response Center.

Calling the Concierge

1. Press the **MENU** button.
This opens the start menu.
2. Move the controller forwards to select "Communication".
3. If necessary, move the highlight marker to the uppermost field. Turn the controller until "BMW Assist" is selected and press the controller.



4. Select "Concierge" and press the controller.



5. Select "Start service" and press the controller.

The BMW Assist Response Center will connect you with a BMW Assist Concierge.

Displaying transmitted data

Select a received message, if applicable, and press the controller.



Dialing a phone number or transferring an address for destination guidance

1. Select "Options" and press the controller.



2. Select a menu item:
 - ▷ Press "Call" to make a telephone call. A prerequisite for this is that your Bluetooth mobile phone has been paired with the vehicle.
 - ▷ Press "Select as destination" to transfer the address to the navigation system for destination guidance.

Adapting BMW Assist

Displaying and updating services

If the services offered by BMW Assist change, you will be notified. In that event you may update the service functions.

1. Press the **MENU** button.
This opens the start menu.
2. Press the controller to open the **i** menu.

- Turn the controller until "Settings" is selected and press the controller.



- Turn the controller until "BMW Service settings" is selected and press the controller.



- If necessary, move the highlight marker to the uppermost field. Turn the controller until "Enabled Assist services" is selected and press the controller. The currently available BMW Assist services are displayed.
- If necessary, select "Options" and press the controller.

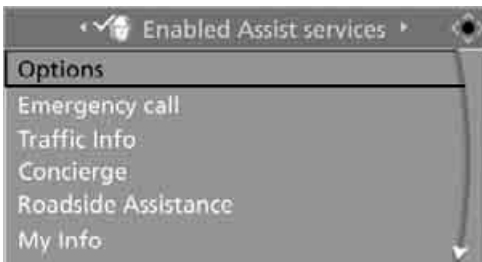

- Select "Update services" and press the controller.

Activating BMW Assist

BMW Assist must be activated to use the services.

Requirements

- Make sure that the vehicle can determine its current location. Reception is best when you have an unobstructed view to the sky.
- Leave vehicle ignition switched on during the activation process.

Activating

- Press the **MENU** button. This opens the start menu.



- Press the controller to open the **i** menu.
- Turn the controller until "Settings" is selected and press the controller.



- Turn the controller until "BMW Service settings" is selected and press the controller.

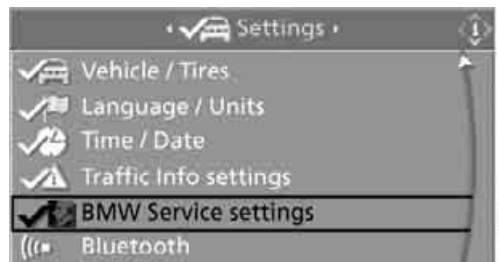

- If necessary, move the highlight marker to the uppermost field. Turn the controller

until "Enabled Assist services" is selected and press the controller.



6. Select "Enable services" and press the controller. BMW Assist is activated and data exchange with the BMW Assist Response Center begins.



Activation takes a few minutes. Progress status is displayed on the Control Display. If you open another menu, the activation process continues in the background.

Displaying vehicle data

When BMW Assist is enabled, you can have the system display the Telematics ID. The Telematics ID identifies your vehicle. These data are transmitted to your BMW center.

1. Press the **MENU** button. This opens the start menu.



2. Press the controller to open the **i** menu.
3. Turn the controller until "Settings" is selected and press the controller.



4. Select "BMW Service settings" and press the controller.



5. If necessary, move the highlight marker to the uppermost field. Turn the controller

until "Assist profile" is selected and press the controller.







Mobility

This section helps you maintain your car's mobility by supplying important information on vital topics including fuels and lubricants, wheels and tires, service, maintenance and roadside assistance.

Refueling

⚠ Always switch off the engine before refueling, otherwise, fuel cannot be added to the tank and a message will be displayed. ◀

⚠ Take all precautionary measures and observe all applicable regulations when handling fuel. Do not carry any spare fuel containers in your vehicle. They can develop a leak and cause an explosion or cause a fire in the event of an accident. ◀

Fuel filler door

Opening

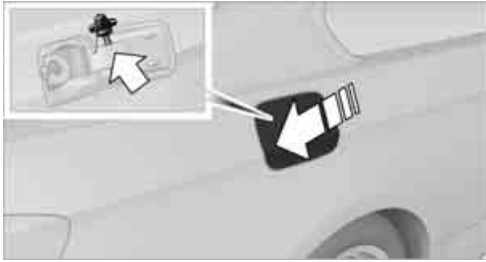

1. Open fuel filler door. To do so, lightly press the rear edge.
2. Turn the gas cap counterclockwise.
3. Place the gas cap in the bracket attached to the fuel filler door.

Closing

Fit the cap and turn it clockwise until you clearly hear a click.

⚠ Do not pinch the band attached to the cap, otherwise the cap cannot be closed properly and fuel vapors can escape. A message will be displayed if the gas cap is loose or missing. ◀

Manually releasing the fuel filler door

In the event of a malfunction, you can release the fuel filler door manually:

Coupe



1. Remove the cover from the right-hand side-wall of the cargo bay.
2. Pull the knob with the fuel pump symbol. The fuel filler door is released.

Convertible

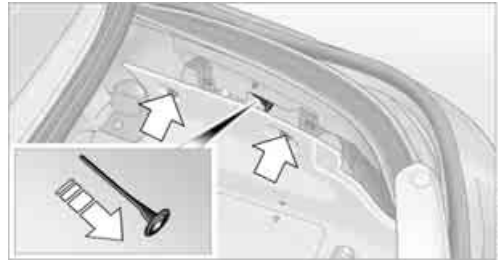

1. Loosen the right-hand cargo bay trim panel by turning the screws by 90°, see arrow.
2. Slightly lift the top section of the panel. It is not necessary to remove the entire panel.
3. Pull the knob with the fuel pump symbol. The fuel filler door is released.

Observe the following when refueling

⚠ When handling fuels, follow the safety instructions provided at filling stations, otherwise there is a risk of personal injury or property damage. ◀

When refueling, insert the filler nozzle completely into the filler pipe. Avoid lifting the filler nozzle while filling the tank, as that would lead to

- ▷ premature pump shutoff

- ▷ reduced efficiency of the fuel-vapor recovery system.

The fuel tank is full when the filler nozzle clicks off the first time.

Fuel tank capacity

Approx. 16.6 US gal/63 liters, including the reserve capacity of 3.3 US gal/12.5 liters.

 Refuel as soon as possible once your cruising range falls below 30 miles/50 km, otherwise engine functions are not ensured and damage can occur. ◀

Fuel specifications

 Do not fill the tank with leaded fuel, as this would cause permanent damage to the catalytic converter.

Do not fill the tank with E85, i.e. fuel containing 85% ethanol, nor with FlexFuel. Otherwise the engine and fuel supply system will be damaged. ◀

Required fuel

Super Premium Gasoline/AKI 93

Always use this premium grade fuel to obtain maximum fuel economy and performance.

The minimum approved fuel grade is AKI 91.

 Do not use any gasoline below the specified minimum fuel grade. Otherwise the engine could be damaged. ◀

Use high-quality brands

Field experience has indicated significant differences in fuel quality: volatility, composition, additives, etc., among gasolines offered for sale in the United States and Canada. Fuels containing up to and including 10% ethanol or other oxygenates with up to 2.8% oxygen by weight, that is, 15% MTBE or 3% methanol plus an equivalent amount of co-solvent, will not void the applicable warranties with respect to defects in materials or workmanship.

 The use of poor-quality fuels may result in driveability, starting and stalling problems

especially under certain environmental conditions such as high ambient temperature and high altitude.

Should you encounter driveability problems which you suspect could be related to the fuel you are using, we recommend that you respond by switching to a recognized high-quality brand such as gasoline that is advertised as Top Tier Detergent Gasoline.

Failure to comply with these recommendations may also result in unscheduled maintenance. ◀

Wheels and tires

Tire inflation pressures

Information for your safety

It is not merely the tires' service life, but also driving comfort and, to a great extent, driving safety that depend on the condition of the tires and the maintenance of the specified tire pressure.

Checking pressure

Only check tire inflation pressure when the tires are cold. This means after a maximum of 1.25 miles/2 km driving or when the vehicle has been parked for at least 2 hours. When tires are warm, the tire inflation pressure is higher.

 Check the tire inflation pressure regularly and correct it, if necessary: at least twice a month and before starting long trips. If you fail to observe this precaution you may be driving on tires with incorrect tire pressures, a condition that can not only compromise your vehicle's driving stability, but also lead to tire damage and the risk of an accident. Do not drive on a flat tire. A flat tire will seriously impair your vehicle's handling and braking response. Attempts to drive on a flat tire can lead to loss of control over the vehicle. ◀

 After correcting the tire inflation pressure, reinitialize the Flat Tire Monitor, refer to page 91, or reset the Tire Pressure Monitor, refer to page 92. ◀

Inflation pressure specifications

The table below provides all the correct inflation pressures for the specified tire sizes at ambient temperature.

 The inflation pressures apply to the tire sizes approved and tire brands recommended by BMW; a list of these is available from your BMW center. ◀

For correct identification of the right tire inflation pressures, observe the following:

- ▷ Tire sizes for your vehicle

- ▷ Load conditions
- ▷ Maximum allowable driving speed

Tire inflation pressures for driving up to 100 mph or 160 km/h

For normal driving up to 100 mph or 160 km/h and to achieve optimum driving comfort, adjust pressures to the respective tire inflation pressures listed on the following page in the columns for traveling speeds up to a maximum of 100 mph or 160 km/h.

These tire inflation pressures can also be found on the driver's-side door post when the driver's door is open.





 The maximum permissible speed for these tire pressures is 100 mph or 160 km/h. Do not exceed this speed, otherwise tire damage and accidents could occur. ◀

Tire inflation pressures for driving above 100 mph or 160 km/h

 In order to drive at maximum speeds in excess of 100 mph or 160 km/h, adjust pressures to the respective tire inflation pressures listed on the following page in the columns for traveling speeds including those exceeding 100 mph or 160 km/h. Otherwise tire damage and accidents could occur. ◀



Observe all national and local maximum speed limits, otherwise violations of the laws could occur.

Coupe: tire inflation pressures

Tire size	Pressure specifications in psi/kPa						
	Traveling speeds up to a max. of 100 mph / 160 km/h		Traveling speeds including those exceeding 100 mph / 160 km/h				
All pressure specifications in the table are indicated in psi/kilopascal with cold tires. Cold = ambient temperature							
	235/40 R 18 M+S	33/230	36/250	33/230	36/250	38/260	44/300
	Front: 245/40 ZR 18	33/230	-	33/230	-	39/270	-
	Rear: 265/40 ZR 18	-	35/240	-	35/240	-	44/300
	Front: 245/35 ZR 19	33/230	-	33/230	-	41/280	-
Rear: 265/35 ZR 19	-	35/240	-	35/240	-	44/300	

More details on the permissible load and weights can be found on page [251](#).

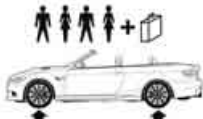
Convertible: tire inflation pressures

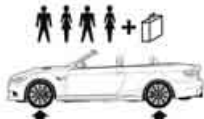
Tire size	Pressure specifications in psi/kPa						
	Traveling speeds up to a max. of 100 mph / 160 km/h		Traveling speeds including those exceeding 100 mph / 160 km/h				
All pressure specifications in the table are indicated in psi/kilopascal with cold tires. Cold = ambient temperature							
	235/40 R 18 M+S	36/250	42/290	36/250	42/290	41/280	51/350
	Front: 245/40 ZR 18	33/230	-	35/240	-	41/280	-
	Rear: 265/40 ZR 18	-	35/240	-	35/240	-	46/320
	Front: 245/35 ZR 19	36/250	-	35/240	-	42/290	-
Rear: 265/35 ZR 19	-	38/260	-	35/240	-	46/320	

More details on the permissible load and weights can be found on page [251](#).

Tire identification marks

Knowledge of the labeling on the side of the tire makes it easier to identify and choose the right tires.

Tire size

e.g. 245/35 ZR 19
 235/40 R 18 100 V

Nominal width in mm |
 Aspect ratio in % |
 Radial belt construction |
 Rim diameter in inches |
 Load rating, _____ |
 not on ZR tires |
 Speed code letter, in _____ |
 front of the R on ZR tires

Speed code letter

- Q = up to 100 mph/160 km/h
- T = up to 118 mph/190 km/h
- H = up to 131 mph/210 km/h
- V = up to 150 mph/240 km/h
- W = up to 167 mph/270 km/h
- Y = up to 186 mph/300 km/h
- Z = over 150 mph/240 km/h

Tire Identification Number

Tires with DOT codes meet the guidelines of the US Department of Transportation.

DOT code:

e.g. DOT xxxx xxx 4607

Manufacturer's code _____ |
 for tire make |
 Tire size and _____ |
 tire design |
 Tire age _____ |

Tire age

The manufacturing date of tires is contained in the tire coding: DOT ... 0708 means that the tire was manufactured in week 7 of 2008.

BMW recommends that you replace all tires after 6 years at most, even if some tires may last for 10 years.

Uniform Tire Quality Grading

Quality grades can be found where applicable on the tire sidewall between tread shoulder and maximum section width. For example:

Tread wear 200 Traction AA
 Temperature A

DOT Quality Grades

Tread wear
 Traction AA A B C
 Temperature A B C



All passenger car tires must conform to Federal Safety Requirements in addition to these grades. ◀

Tread wear

The tread wear grade is a comparative rating based on the wear rate of the tire when tested under controlled conditions on a specified government test course. For example, a tire graded 150 would wear one and one-half (1 ½) times as well on the government course as a tire graded 100. The relative performance of tires depends upon the actual conditions of their use, however, and may depart significantly from the norm due to variations in driving habits, service practices and differences in road characteristics and climate.

Traction

The traction grades, from highest to lowest, are AA, A, B, and C. Those grades represent the tire's ability to stop on wet pavement as measured under controlled conditions on specified government test surfaces of asphalt and concrete. A tire marked C may have poor traction performance.



The traction grade assigned to this tire is based on straight-ahead braking traction tests, and does not include acceleration, cornering, hydroplaning, or peak traction characteristics. ◀

Temperature

The temperature grades are A, the highest, B, and C, representing the tire's resistance to the generation of heat and its ability to dissipate heat when tested under controlled conditions on a specified indoor laboratory test wheel. Sustained high temperature can cause the material of the tire to degenerate and reduce tire life, and excessive temperature can lead to sudden tire failure. The grade C corresponds to a level of performance which all passenger car tires must meet under the Federal Motor Vehicle Safety Standard No. 109. Grades B and A represent higher levels of performance on the laboratory test wheel than the minimum required by law.

 The temperature grade for this tire is established for a tire that is properly inflated and not overloaded. Excessive speed, underinflation, or excessive loading, either separately or in combination, can cause heat buildup and possible tire failure. ◀

M+S

Winter and all-season tires. These have better winter properties than summer tires.

XL

Designation for specially reinforced tires.

Tire condition

Inspect your tires frequently for tread wear, signs of damage and for foreign objects lodged in the tread. Check the tread depth.

Minimum tread depth

The tread depth should not drop below 1/8 in/3 mm, although, for example, European legislation only specifies a minimum tread depth of 1/16 in/1.6 mm. At tread depths below 1/8 in/3 mm there is an increased risk of high-speed hydroplaning, even when only small amounts of water are present on the road surface. When winter tires wear down past a tread depth of 1/6 in/4 mm, they become perceptibly less

suitable for winter conditions. In the interest of safety, new tires should be installed.



Wear indicators in the base of the tread groove are distributed around the tire's circumference; the letters TWI, for Tread Wear Indicator, on the tire's sidewalls identify tires that incorporate these wear indicators. Once the tire tread has worn down to the wear indicators, the tire has worn to a depth of 1/16 in/1.6 mm.

Wheel/tire damage

Please note that low-profile tires cause wheels, tires and suspension parts to be more susceptible to road hazard and consequential damages.

Unusual vibrations encountered during normal vehicle operation can indicate tire failure or some other vehicle defect. This can, for example, be caused by driving over curbs. The same applies to any other abnormal road behavior, such as pulling severely to the right or left.

 In these cases, reduce speed immediately and have wheels and tires thoroughly checked. To do so, drive carefully to the nearest BMW center or tire shop that works according to BMW repair procedures with correspondingly trained personnel. If necessary, have the vehicle towed there. Otherwise, tire damage can pose a lethal hazard to vehicle occupants and other road users. ◀

New wheels and tires

 Have new wheels and tires installed only by your BMW center or tire shop that works according to BMW repair procedures with correspondingly trained personnel. If this

work is not carried out properly, there is a danger of subsequent damage and related safety hazards. Make sure that the new wheels are balanced. ◀

Retreaded tires

 BMW recommends that you do not use retreaded tires, since driving safety may be impaired. The causes for this include potentially different tire casing structures and often wide variations in tire age, which can result in a limited service life. ◀

Correct wheels and tires

 BMW recommends that you use only wheel and tire combinations that BMW has tested and approved for your particular vehicle. Variations in factors such as manufacturing tolerances mean that even wheels and tires with identical official size ratings could actually have different dimensions, which could lead to body contact and thus to severe accidents. When selecting tires, also take their load capacity into account. If non-approved wheels and tires are used, BMW cannot evaluate their suitability, and therefore cannot guarantee their driving safety. ◀

You can inquire about the right wheel/tire combination at your BMW center.

The correct combination of wheels and tires is also necessary to ensure reliable operation of various vehicle systems such as ABS or DSC.

To maintain good handling and vehicle response, use only tires of a single brand and tread configuration. After a tire has been damaged, mount the previous wheel and tire combination again as soon as possible.

Wheels with Tire Pressure Monitor TPM electronics

When mounting new tires or changing over from summer to winter tires, or vice versa, only use wheels with TPM electronics; otherwise the Tire Pressure Monitor may not be able to detect a puncture, refer to page 92. Your BMW center will be glad to advise you.

Recommended tire brands



Certain makes of tire are recommended by BMW for each tire size. They are marked with a clearly visible BMW designation on the sidewall of the tire.

When properly used, these tires meet the highest standards in terms of safety and handling characteristics.

Special characteristics of winter tires

BMW recommends winter tires for use in cold winter driving conditions. Although all-season M+S tires provide better winter traction than summer tires, they generally fail to provide the same levels of cold-weather performance as winter tires.

Pay attention to speed

 Always comply with the speed limit for the winter tires mounted on your car; failure to do so could result in tire damage and accidents. ◀

Storage

Store wheels and tires in a cool, dry place with as little exposure to light as possible. Always protect tires against all contact with oil, grease and fuels. Do not exceed the maximum tire inflation pressure indicated on the sidewall of the tire.

Swapping wheels between axles

BMW advises against swapping wheels between the front and rear axles, even if all tires have the same size, as this could impair driving characteristics. With standard-equipment tires

and other mixed tire sizes, swapping wheels between the axles is not permissible.

Snow chains*

Only certain fine-link snow chains have been tested by BMW, classified as safe for use and recommended. Consult your BMW center for more information.

Snow chains must be mounted in pairs and on the rear wheels only. Observe the manufacturer's instructions when mounting snow chains. Do not exceed a speed of 30 mph or 50 km/h.

Ensure that the snow chains are sufficiently tensioned at all times. If necessary, retension as specified by the snow chain manufacturer.

 Do not initialize the Flat Tire Monitor if snow chains are mounted, otherwise the instrument might issue an incorrect reading. ◀

Under the hood

! Do not work on the car unless you possess the necessary technical knowledge. If you are unfamiliar with the statutory guidelines, have any work on the vehicle performed only by a BMW center or by a workshop that work according to BMW repair procedures with correspondingly trained personnel. If this work is not carried out properly, there is a danger of subsequent damage and related safety hazards. ◀

Hood

Releasing



Pull the lever.

Opening



! To avoid damage, make sure that the wiper arms are against the windshield before you open the engine compartment. Do not open the engine hood before the engine has cooled down, otherwise injuries may result. ◀

Press the release handle and open the hood.

Closing

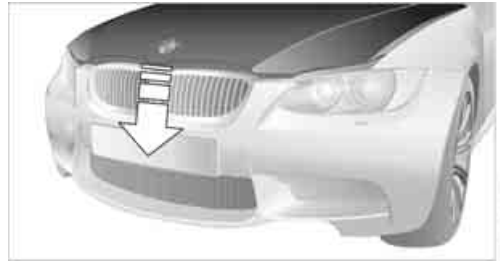

Close the hood from a height of approx. 20 in/ 50 cm with momentum. It must be clearly heard to engage.

! Make sure that the closing path of the hood is clear, otherwise injuries may result.

If you see any signs while driving your vehicle that the hood is not completely closed, stop at once and close it securely. ◀

Important parts of the engine compartment



- 1 Expansion tank for coolant, refer to page [226](#)
- 2 Washer fluid filler neck for headlamp cleaning system and window washer system, refer to page [70](#)
- 3 Jump-starting connection, refer to page [242](#)
- 4 Filler neck for engine oil, refer to [Adding engine oil](#)

Engine oil

The engine oil consumption is dependent on driving style and driving conditions.

Checking oil level

Your car is equipped with an electronic oil-level monitor.

The oil level can be displayed when the engine is warm. Continuous short distance travel or a very sporty driving style may make measurement impossible.

Display in the instrument cluster

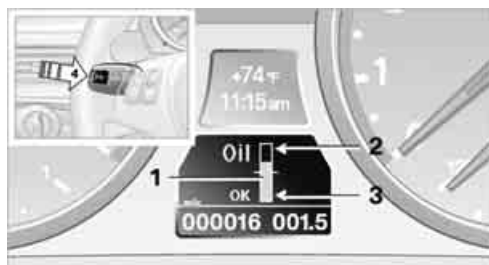

- 1 Oil level
- 2 Maximum mark
- 3 Minimum mark
- 4 Computer button

Press button **4** in the turn indicator lever repeatedly until the oil level display appears in the instrument cluster.

 M dual clutch transmission: the oil level appears in the top display. ◀

The oil level must be between the two markings.

A new measurement is taken automatically each time the engine is started.

Possible displays

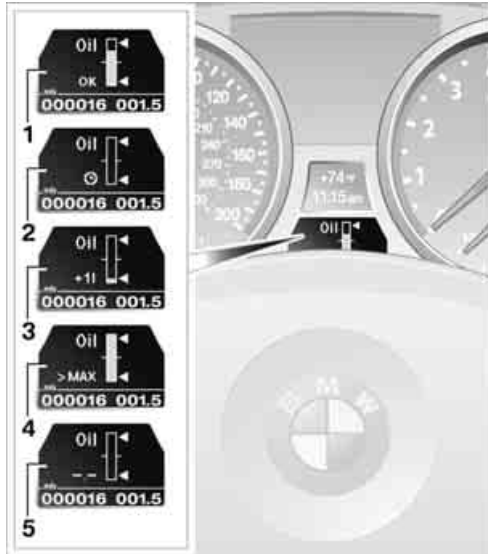

- 1 Oil level OK.
- 2 Oil level is being checked.
This can take about 1 minute if the car is at a standstill on a level surface, or about 5 minutes while the car is moving.
If engine oil was added, it can take up to 30 minutes to get an oil level reading.
- 3 Oil level down to minimum:
Add engine oil at the next opportunity, but no more than 1 US quart/1 liter, refer also to Adding engine oil on page 225. Add at least 0.5 US quart/0.5 liters, otherwise the oil-level monitor will be unable to display the new value reliably.
If the oil level is below the minimum value,

add engine oil immediately to avoid engine damage.

- 4 Oil level is too high.

 Have the vehicle checked immediately, otherwise the excess oil may lead to engine damage. ◀

- 5 A value cannot be read at this time. The engine is not yet warm.

Quick measurement

In addition to the automatic measurement, you can also determine the current oil level manually, e.g. after adding engine oil, but such measurements are less accurate.

1. Park the vehicle with a warm engine, i.e. after an uninterrupted drive of at least 6 miles/10 km, on a horizontal surface.
2. Let the engine idle.
3. Press the computer button in the turn indicator lever repeatedly until the oil level display appears in the instrument cluster.
4. Press the computer button for at least 2 seconds.
The oil level is determined. A clock symbol appears during measurement.
5. After approx. 1 minute, the current oil level is displayed.

Display via iDrive

iDrive, for operating principle refer to page 16.

1. Press the **MENU** button.
This opens the start menu.
2. Press the controller to open the **i** menu.
3. Select "Info sources" and press the controller.



4. Select "Service Info" and press the controller.
5. If necessary, move the highlight marker to the uppermost field. Turn the controller until "Service requirements" is selected and press the controller.



6. If necessary, move the highlight marker to the second field from the top. Turn the controller until "Engine oil level" is selected and press the controller. The oil level is displayed.

Possible messages

- ▷ "Engine oil level O.K."
- ▷ "No measurement available: Updating engine oil level measurement..."
The engine oil level is measured. This can take about 1 minute if the car is at a standstill on a level surface and the engine is running, or about 5 minutes while the car is moving.
If engine oil was added, it can take up to 30 minutes to get an oil level reading.
- ▷ "Oil level at the minimum! Refill with 1 quart of engine oil."
Add engine oil as soon as possible, but no more than 1 US quart/1 liter, refer also to Adding engine oil below. Add at least 0.5 US quart/0.5 liters, otherwise the oil-level monitor will be unable to display the new value reliably.
If the oil level is below the minimum value, add engine oil immediately to avoid engine damage.
- ▷ "Engine oil level too high"

 Have the vehicle checked immediately, otherwise the excess oil may lead to engine damage. ◀

- ▷ "Please observe recalculated service interval for engine oil"
Do not add engine oil. Before resuming your trip, note the newly calculated distance remaining to the next oil service, refer to page 78. Have the system checked as soon as possible.

Adding engine oil



Do not add 1 US quart/1 liter of engine oil until a corresponding message is shown on the Control Display.

 Add oil within the next 125 miles/200 km, otherwise the engine could be damaged. Add no more than 1 US quart/1 liter of oil, otherwise too much engine oil can lead to engine damage. Add at least 0.5 US quart/0.5 liters, otherwise the oil-level monitor will be unable to display the new value reliably. ◀

 Keep oils, greases, etc. out of the reach of children and comply with the relevant warnings on the containers. Otherwise, health hazards may result. ◀

Oil change

Have oil changed only at your BMW center or at a workshop that works according to BMW repair procedures with correspondingly trained personnel.

Specified engine oils

The quality of the engine oil selected has critical significance for the operation and service life of an engine. BMW continuously approves spe-

cific oils after confirming their suitability for use in its vehicles with extensive testing.

 Do not use oil additives as these may cause engine damage. ◀

 Your BMW center will be glad to answer any questions regarding BMW High Performance Synthetic Oil or approved synthetic oils. ◀

You can also call BMW of North America at 1-800-831-1117 or visit the website www.bmwusa.com to obtain this information.

Viscosity ratings

Viscosity is a measure of an oil's flow rating and is categorized in SAE classes.

 Approved oils belong to the 10W-60 SAE class. ◀

Alternative oil types

If BMW High Performance Synthetic Oil is not available, you can add small quantities of other synthetic oils in between oil changes. Only use oils with the following specifications:

- ▶ Viscosity:
preferred: SAE 10W-60;
alternative: SAE 10W-40, SAE 5W-50 or SAE 10W-50
- ▶ Specification:
API SJ/CF, API SK/CF or higher

Low ambient temperatures

The oils used at BMW factories for your vehicle type are suitable for virtually any ambient temperature. However, if the vehicle is operated at temperatures below -4°F / -20°C for extended periods, your BMW center will be glad to recommend an optimal oil.

BMW recommends 

Coolant

 Do not add coolant to the cooling system when the engine is hot. Escaping coolant can cause burns. ◀

Coolant consists of half water and half additive. Not all commercially available additives are suitable for your BMW. Ask your BMW center for suitable additives.

 Only use suitable additives, otherwise engine damage may result. Because additives are harmful to your health, it is important to follow the instructions on the containers. ◀

 Comply with the appropriate environmental protection regulations when disposing of coolant additives. ◀

Checking coolant level

1. Do not open the engine hood before the engine has cooled down.
2. Turn the cap of the expansion tank a little counterclockwise to allow any accumulated pressure to escape, then continue turning to open.
3. The coolant level is correct if it is between the maximum and minimum marks in the filler neck, refer also to the diagram next to the filler neck.



4. If the coolant is low, slowly add coolant up to the specified level; do not overfill.
5. Turn the cap until there is an audible click.
6. If the loss of coolant is substantial, have the cause eliminated as soon as possible.

BMW Maintenance System

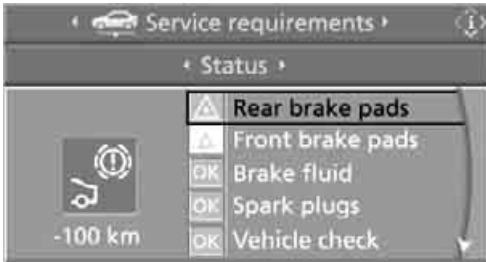

The BMW Maintenance System supports the preservation of the traffic and operating safety of your BMW. The objective is to optimize efforts with respect to minimal vehicle maintenance costs.

If and when you come to sell your BMW, a comprehensive record of servicing will prove a significant benefit.

Condition Based Service CBS

Sensors and special algorithms take the different driving conditions of your BMW into account. Condition Based Service uses this to determine the current and future service requirements. By letting you define a service and maintenance regimen that reflects your own individual requirements, the system builds the basis for trouble-free driving.

On the Control Display, you can have the remaining times or distances for selected maintenance tasks and any legally prescribed dates displayed, refer to page 78:

- ▷ Engine oil
- ▷ Brake pads: separately for front and rear
- ▷ Brake fluid
- ▷ Vehicle check
- ▷ Legally mandated inspections depending on local regulations

Service data in the remote control

Your vehicle continuously stores service-requirement information in the remote control while you are driving. Your BMW Service Advisor can read out this data from the remote control unit, and propose an optimized maintenance approach. Whenever you take your car in for servicing you should therefore hand your BMW Service Advisor the remote control unit that you last used.

 Make sure that the date is always set correctly, refer to page 82; otherwise the effectiveness of Condition Based Service CBS is not assured. ◀

Service and Warranty Information Booklet for US models and Warranty and Service Guide Booklet for Canadian models

Please consult your Service and Warranty Information Booklet for US models and Warranty and Service Guide Booklet for Canadian models for additional information on service requirements.

 BMW recommends that you have service and repair operations performed at your BMW center.

Take the time to ensure that these service procedures are confirmed by entries in your vehicle's Service and Warranty Information Booklet for US models and Warranty and Service Guide Booklet for Canadian models. These entries verify that your vehicle has received the specified regular maintenance. ◀

Socket for On-Board Diagnosis OBD

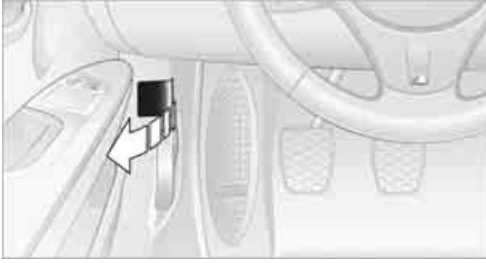

Primary components that make up exhaust emissions can be checked by a device via the OBD socket.

This socket is located on the driver's side to the left, on the bottom of the instrument panel underneath a cover.

Exhaust emission values

SERVICE ENGINE SOON The warning lamp lights up: The exhaust emission values have worsened. Have the car checked as soon as possible.



Canadian models display this warning lamp.

The lamp flashes under certain conditions. This indicates excessive misfiring in the engine. If this happens, you should reduce your speed and visit your nearest BMW center as soon as possible. Severe engine misfiring can quickly lead to serious damage of emissions-related components, especially the catalytic converter.



The warning lamp comes on if the gas cap is not properly tightened and the OBD system assumes that fuel vapor is escaping. If the gas cap is then tightened, the warning lamp should go out within a few days.

Event data recorders

Your vehicle may be equipped with one or several measuring or diagnostic modules or a device for recording or sending certain vehicle data or information. In addition, if you have signed a service contract for BMW Assist, cer-

tain vehicle data may be transmitted or recorded in order to facilitate the corresponding services.

Care products

Regular cleaning and care contributes significantly to the value retention of your BMW.

BMW recommends cleaning and caring for your vehicle with products that are approved by BMW for this purpose.

Your BMW center will be happy to advise you on the products and services available for cleaning and caring for your BMW.

 Original BMW CareProducts have been material tested, laboratory checked and proven in the field, and offer optimal care and protection for your vehicle. ◀

 Do not use cleaners that contain alcohol or solvents as these may result in damage. ◀

 Cleaning agents can contain substances that are dangerous or hazardous to your health. Therefore, follow the warning and safety instructions on the packaging. When cleaning inside the vehicle, always open the doors or windows of the vehicle. In enclosed areas, provide for sufficient ventilation. Only use products designed for cleaning vehicles. ◀

Exterior care

Washing the vehicle

 Especially during the winter months, ensure that the vehicle is washed more frequently. Heavy soiling and road salt can lead to vehicle damage. ◀

 After washing the vehicle, apply the brakes briefly to dry them, otherwise water can reduce braking efficiency over the short term and the brake discs can corrode. ◀

Automatic car washes

Preference should be given to cloth car washes.

 Do not use high-pressure car washes, otherwise water may drip into the vehicle around the windows. ◀

Before driving into a car wash, ensure that it is suitable for your BMW. Check the following:

- ▷ Dimensions of your vehicle, refer to page 249.
- ▷ If necessary: fold in the exterior mirrors, refer to page 51.
- ▷ Maximum permissible tire width.

Preparations before driving into an automatic car wash:

- ▷ Deactivate the rain sensor* to avoid unintentional activation of the wipers.
- ▷ Remove additional attachments, e.g. spoiler or telephone antennas, if there is a possibility that they could be damaged.

M dual clutch transmission

Before driving into an automatic car wash, perform the following steps to ensure that the vehicle can roll:

1. Insert the remote control, even with convenient access, into the ignition lock.
2. Engage transmission position N.
3. Release the parking brake.
4. Switch off the engine.
5. Leave the remote control in the ignition lock so that the vehicle can roll.

Steam jets / high-pressure washers

 When using steam jets or high-pressure washers, ensure that you maintain a sufficient clearance to the vehicle and do not exceed a temperature of 140 °F / 60 °C.

Insufficient clearance or excessive pressure or temperature can lead to component damage or water penetration. Follow the operating instructions of the high-pressure washer. ◀

 When using high-pressure washers, do not spray against the sensors and cam-

eras, e.g. Park Distance Control, for an extended period and maintain a distance of at least 12 in/30 cm. ◀

Washing the car manually

When washing the vehicle by hand, use large quantities of water and car shampoo if necessary. Clean the vehicle with a sponge or washing brush, applying light pressure only.

 Before cleaning the windshield, deactivate the rain sensor or switch off the ignition to prevent unintentional activation of the wipers. ◀

 Observe local regulations pertaining to washing vehicles by hand. ◀

Headlamps

Do not rub them dry and do not use abrasive or corrosive cleaning agents.

Remove contamination, such as insects, by soaking with shampoo or insect remover and then rinsing with plenty of water.

Thaw ice with a windshield de-icer and do not use an ice scraper.

Windows

Clean the inside and outside surfaces of the windows and the mirrors with window cleaner.

 Do not clean the mirrors with cleaners containing quartz. ◀

Wiper blades

Clean with soapy water and replace regularly to avoid streaking.

 Wax and preservative residue and contamination on the window can lead to streaking when operating the windshield wipers, leading to premature wear of the wiper blades and causing the rain sensor to malfunction. ◀

Convertible: retractable hardtop

Proceed as you would in a normal car wash.

 When you open a wet hardtop, water drops may run into the cargo bay. If nec-

essary, remove items from the cargo bay beforehand to avoid water stains or soiling. ◀

Paintwork care

Regular care contributes to value retention and protects the paintwork against the long-term effects of damaging substances.

Region-specific environmental influences can damage the vehicle paintwork. Therefore, it is important to adapt the frequency and scope of car care accordingly.

Immediately remove very aggressive substances, e.g. spilled fuel, oil, grease, tree resin or bird droppings, to prevent damage to the paintwork.

Repairing paintwork damage

 Immediately repair scratches or similar damage, such as that caused by stones hitting the vehicle, where necessary to prevent rusting. ◀

BMW recommends having paintwork damage repaired by a professional paint repair workshop according to BMW specifications using original BMW paint materials.

Preservation

A preservation treatment is necessary when water no longer beads off of the clean paintwork surface. Only use products for paintwork preservation that contain carnauba or synthetic waxes.

Rubber seals

Treat only with water or rubber care products.

 Do not use silicon-containing care products on rubber seals, otherwise noise and damage could occur. ◀

Chrome parts

Carefully clean vehicle parts, such as the radiator grill, door handles or window frames, with copious quantities of water and a shampoo additive. For additional treatment, use a chrome polish.

Light-alloy wheels

For technical reasons, dust is generated during braking that is deposited on the light-alloy wheels. Remove the dust regularly using acid-free rim cleaner.

 Do not use aggressive, acidic, strongly alkaline and abrasive cleaning agents or steam jets over 140 °F /60 °C, otherwise damage may occur. ◀

Outside sensors / cameras

 Keep the sensors and cameras on the outside of the vehicle, e.g. Park Distance Control, clean and free of ice to ensure that they remain fully functional. ◀

Interior care

Upholstery / cloth trim

Vacuum regularly with a vacuum cleaner to remove superficial dirt.

To treat severe stains, e.g. from beverages, use a soft sponge or lint-free microfiber cloth in combination with suitable interior cleaners. Follow the instructions on the packaging.

 Clean the upholstery down to the seams using a sweeping motion. Avoid strong rubbing. ◀

 Opened Velcro fasteners on pants or other articles of clothing can damage the seat covers. Ensure that Velcro fasteners are closed. ◀

Leather / leather trim

 The leather used by BMW is a high quality natural product. Slight irregularities in the leather are a typical characteristic of natural leather. ◀

Dust and road grit in the pores and folds of the leather have an abrasive effect, leading to increased wear and causing the leather surface to become brittle prematurely. Therefore, frequently clean the leather of dust using a cloth or vacuum cleaner.

In particular, ensure that light-colored leather is cleaned regularly as it has a tendency to soil more easily.

Treat the leather twice a year using a leather lotion as dirt and grease will gradually attack the leather's protective layer.

Carpets / cargo bay

You can vacuum the carpets and floor mats or clean them with interior cleaner if heavily soiled.

The floor mats can be removed for cleaning. When replacing the mats, ensure that the seat rails do not extend over the floor mats, as this may damage the mats.

Lint on the floor mats occurs for technical reasons and can be removed by vacuuming repeatedly.

Interior plastic parts

- ▷ Imitation leather surfaces
- ▷ Lamp glasses
- ▷ Display pane of instrument cluster
- ▷ Matt parts

Clean with water and solvent-free plastic cleaner if necessary.

Fine wood parts

Clean fine wood trim and fine wood parts with a damp cloth. Wipe dry with a soft cloth.

Safety belts

 Do not clean with cleaning agents as these may destroy the fabric. ◀

Interior sensors / cameras

To clean interior sensors and cameras, e.g. of the High-Beam Assistant, use a lint-free cloth moistened with glass cleaner.

Displays

To clean the displays, e.g. of the radio or instrument cluster, use a display cleaning cloth or a soft, non-abrasive, lint-free cloth.



Avoid applying excessive pressure when cleaning the displays, otherwise damage may occur. ◀



Do not use chemical or abrasive household cleaning agents. Keep all types of fluid away from the device. Otherwise, surfaces or electrical components may be corroded or damaged. ◀

CD/DVD drives



Do not use a cleaning CD, as it may damage parts of the drive. ◀

Vehicle storage

If your vehicle is to be decommissioned for longer than three months, your BMW center or a workshop that operates according to BMW specifications will be glad to advise you.

Replacing components

Onboard tool kit

Coupe



The onboard tool kit is stored in a compartment on the right-hand side of the cargo bay. Remove the cover.

Convertible

The onboard tool kit is stored in a pouch under the cargo bay floor panel.

Wiper blades



1. Fold up the wiper arm.
2. Remove the cover. To do so, press the hook on the bottom, see arrow.

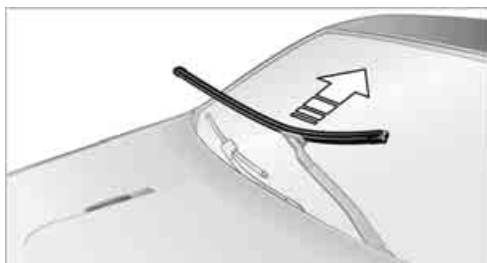

3. Fold the wiper blade upwards.
4. Remove the wiper blade in the direction of the windshield, see arrow.

 To avoid damage, make sure that the wiper arms are against the windshield before you open the engine compartment. ◀

Lamps and bulbs

Lamps and bulbs make an essential contribution to vehicle safety. They should, therefore, be handled carefully. BMW recommends having your BMW center perform any work that you do not feel competent to perform yourself or that is not described here.

 Never touch the glass of new bulbs with your bare fingers, as even minute amounts of contamination will burn into the bulb's surface and reduce its service life. Use a clean tissue, cloth or something similar, or hold the bulb by its base. ◀

You can obtain a selection of replacement bulbs at your BMW center.

 Only change bulbs while they are cool to the touch, otherwise you could suffer burns. ◀

 When working on electrical systems, always begin by switching off the consumer in question, otherwise short-circuits could result. To avoid possible injury or equipment damage when replacing bulbs, observe any instructions provided by the bulb manufacturer. ◀

For care of the headlamps, please follow the instructions in the chapter entitled 'Care'.

 If the routine for changing a particular bulb is not described here, please contact your BMW center or a workshop that works according to BMW repair procedures with correspondingly trained personnel. ◀

Light-emitting diodes LED

Control elements, display components, part of the exterior lighting and other interior equipment in your vehicle are equipped with covered light-emitting diodes as light sources. These light-emitting diodes, which operate using a concept similar to that applied in conventional lasers, are officially designated as Class 1 light-emitting diodes.

 Do not remove the covers or expose the eyes directly to the unfiltered light source for several hours, otherwise this could cause irritation to the retina. ◀

Xenon lamps

These bulbs have a very long service life and are highly unlikely to fail.

 Have any work on the xenon lamp system, including bulb replacements, performed only by a BMW center or a workshop that works according to BMW repair procedures with correspondingly trained personnel. Otherwise, if such work is carried out improperly, the high voltage in the system presents the danger of fatal injuries. ◀

Access to the lamps

1. Switch off the lamps and take the remote control out of the ignition lock.
2. Remove the upper cover from the headlamp. To do so, use a screwdriver to press

the catches towards the rear, see arrows, and pull the cover forward and out.

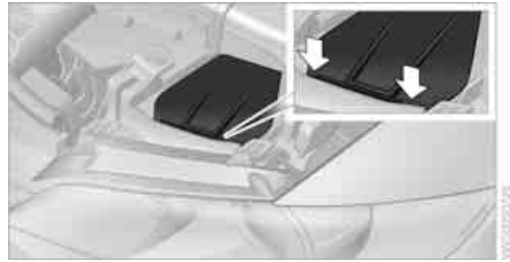

Follow the same steps in reverse order to reattach the cover.

 Be careful when installing the cover, otherwise leaks could occur and cause damage to the headlamp system. ◀

Parking lamps and roadside parking lamps, daytime running lamps

H8 bulb, 35 watts

1. Remove the cover, refer to Access to the lamps.
2. Turn the bulb approx. 90°, see arrow, and take it out.



3. Disconnect the plug, change the bulb and reconnect the plug.
4. Insert the bulb and turn it until it stops.
5. Reattach the cover.

Corner-illuminating lamp*

H3 bulb, 55 watts

1. Switch off the lamps and take the remote control out of the ignition lock.
2. Remove the cover, refer to Access to the lamps.

3. Push the wire bracket out of the anchor towards the right and fold it up.



4. Disconnect the plug, change the bulb and reconnect the plug.
5. Insert the bulb.
6. Fold the wire bracket down and engage it.
7. Reattach the cover.

Turn signals, front

PY24W Silver Vision bulb, 24 watts

The turn signal bulb can be changed via a cover in the wheel arch.



1. Turn the respective wheel inwards.
2. Using a coin, turn both locks of the cover all the way to the left, arrows 1, and remove the cover.
3. Turn the bulb holder to the left, arrow 2, and take it out.
4. Turn the bulb socket in the bulb holder to the right for removal and replacement.
5. Insert the bulb holder and lock it by turning it to the right.
6. Attach the cover by positioning the bottom edge first and then turning both locks all the way to the right.

Tail lamps

- ▷ Turn signal:
PY21W bulb, 21 watts
- ▷ Brake lamp in the luggage compartment lid:
H21W bulb, 21 watts
- ▷ Other lamps:
W16W bulb, 16 watts

The tail lamps are divided in two parts. One part is in the luggage compartment lid, the other is in the fender.



- 1 Turn signal
- 2 Roadside parking lamp/tail lamp, LED
- 3 Backup lamp
- 4 Brake lamp, consisting of two individual bulbs
- 5 Brake Force Display
- 6 Roadside parking lamp/tail lamp, LED

If the bulbs 2 and 6 malfunction, please contact your BMW center or a workshop that works according to BMW repair procedures with correspondingly trained personnel.

Fender-mounted lamps

Coupe

1. Left-hand side: use a screwdriver to pry off the cover in the cargo bay and remove the cover.
Right-hand side: remove the cover from the right-hand side panel of the cargo bay.
2. Loosen the bulb holder at the clip, see arrow, and pull out.

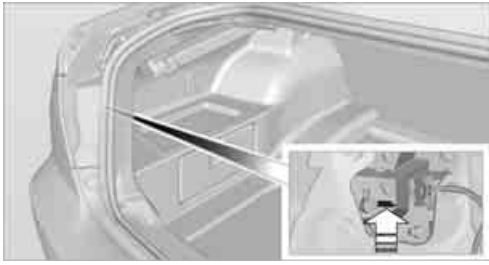

3. Turn signal indicator: apply gentle pressure to the bulb while turning it to the left for removal and replacement.
Backup lamps and brake lamps: take out the bulbs and change them.
4. Re-engage the bulb holder so that it audibly clicks into place.
5. Reattach the cover in the cargo bay.

Convertible

1. Turn the screws on the corresponding side, see arrow, by 90° and remove the cover.

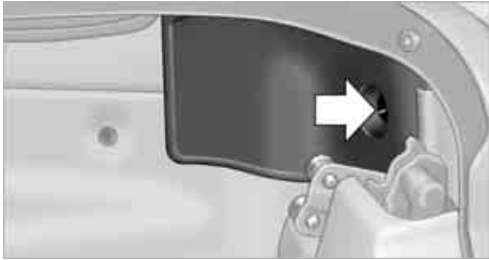

2. While applying light pressure, turn the bulb holder of the turn signal bulb to the left.
3. Remove and replace the bulb.

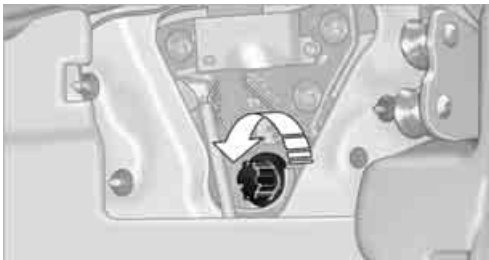

4. Re-engage the bulb holder so that it audibly clicks into place.

5. Reattach the cover in the cargo bay.

Coupe:

Lamps in the luggage compartment lid

1. Using a screw driver, remove the fastening plugs on the edge and in the handle recesses of the luggage compartment lid trim. To do so, first loosen the top part of the plug, see arrow, and then completely remove the plug by pulling on its bottom part. Remove the trim.

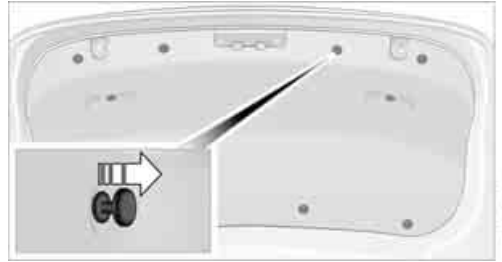

2. Unlock the bulb holder by turning it to the left, see arrow, and take it out.



3. Apply gentle pressure to the bulb while turning it to the left for removal and replacement.
4. Insert the bulb holder and lock it by turning it to the right.
5. Attach the luggage compartment lid trim by inserting the bottom part of the fastening plug and then fixing the plug with its top part.

License plate lamp, center brake lamp, rear lamps and side turn signal indicators

These lamps use LED technology for operation. In the event of a malfunction, please contact your BMW center or a workshop that works according to BMW repair procedures with correspondingly trained personnel.

Repairing a flat tire with the M Mobility System

To repair a flat tire, your BMW M3 includes an M Mobility System. With this system you can apply a sealant to the inside of the tire to seal the damaged section, restore the tire inflation pressure and continue on your trip.

! Safety measures in the event of a flat tire: Park the vehicle as far away from moving traffic as possible and on a firm surface. Switch on the hazard warning flashers.

Apply the parking brake and engage first gear or reverse. Have all occupants leave the vehicle and move beyond the danger zone, e.g. behind the guard rails.

If necessary, erect a warning triangle* or warning flasher* at a suitable distance. Adhere to country-specific regulations. ◀

Preparations



The M Mobility System is located in the cargo bay under the floor board.

If possible, leave any foreign bodies that have penetrated the tire in place.

▷ Instructions on how to use the M Mobility System can also be found on the device itself. ◀

! Before using the M Mobility System, follow the instructions on the sealant bottle. ◀

Remove the label with the speed restriction from the sealant bottle and apply it to the steering wheel.

▷ Please note the expiry date on the sealant bottle. ◀

Components of the M Mobility System



- 1 Sealant bottle and label with speed restriction
- 2 Filling hose from sealant bottle to wheel

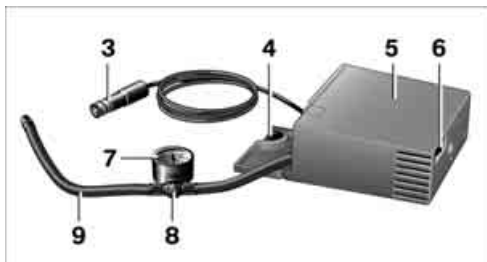

- 3 Connector and cable for the cigarette lighter socket
- 4 Holder for the sealant bottle
- 5 Compressor
- 6 On/off switch
- 7 Pressure gauge for displaying the tire inflation pressure
- 8 Screw on pressure gauge to reduce tire inflation pressure
- 9 Hose to connect compressor and sealant bottle or compressor and wheel

The connector, cable and connection hose are stored in the compressor housing.

Using the M Mobility System

To repair a flat tire with the M Mobility System, proceed as follows:

- ▷ Fill the sealant, refer to page 238.
- ▷ Distribute the sealant, refer to page 238.
- ▷ Produce the tire inflation pressure, refer to page 238.

Filling the sealant

 Strictly follow the specified sequence, otherwise the sealant may escape under high pressure. ◀

1. Shake the sealant bottle.
2. Screw connection hose **9** onto the connector of the sealant bottle.
3. Ensure that screw **8** on the pressure gauge is closed.
4. Unscrew the dust cap from the valve of the defective wheel and screw filling hose **2** of the sealant bottle onto the valve.
5. Insert the sealant bottle into the housing of the compressor so that the bottle is upright.



6. Ensure that the compressor is switched off, position 0.
7. Insert connector **3** into the cigarette lighter socket in the interior of the vehicle, refer to page 115.
8. With the ignition switched on: Switch on the compressor and let it run for approx. 3 minutes to fill the sealant. The inflation pressure of the tire after filling is unimportant.
9. Switch off the compressor.
10. Detach the hoses from the sealant bottle connector and from the tire valve.

Return the M Mobility System to its storage location in the vehicle.

Distributing the sealant

Immediately drive approx. 2 miles/3 km to evenly distribute the sealant in the tire.

-  Do not exceed a speed of 35 mph/60 km/h. If possible, do not fall below a speed of 12 mph/20 km/h. ◀

Producing the tire inflation pressure

1. After driving approx. 2 miles/3 km, stop at a suitable location.
2. Connect connection hose **9** of the compressor directly to the tire valve.
3. Insert connector **3** into the cigarette lighter socket in the interior of the vehicle.
4. Adjust the tire inflation pressure to 29 psi/200 kPa. With the ignition switched on, proceed as follows:

- ▷ To increase the inflation pressure: Switch on the compressor, position I. To check the current inflation pressure setting, briefly switch off the compressor.

 Do not let the compressor run for more than 10 minutes, otherwise the device will overheat and may be damaged. ◀

- ▷ To reduce the inflation pressure: turn screw **8** on the pressure gauge.

-  If the inflation pressure is not maintained, drive the vehicle a second time, refer to Distributing the sealant. Then repeat steps 1 to 4.

Use of the M Mobility System may be ineffectual for tire damage larger than approx. 0.16 in/4 mm. Please contact the nearest BMW center, refer to page 241, or a workshop that works accordingly trained personnel if the tire cannot be made roadworthy with the M Mobility System. ◀

 The tire inflation pressure must be at least 29 psi/200 kPa. If it is not, do not continue driving. ◀

Continuing your trip

 Do not exceed the maximum allowable speed of 50 mph/80 km/h to avoid the risk of an accident. ◀

 Reinitialize the Flat Tire Monitor, refer to page 91 for more information. Have the faulty tire and the sealant bottle of the M Mobility System replaced as soon as possible. ◀

Changing wheels

 The tools for changing wheels are available as optional accessories from your BMW center. ◀

Jack mounting points

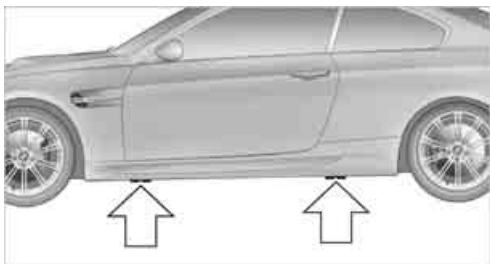

The jacking points are at the positions shown in the illustration.

Vehicle battery

Battery care

The battery is 100% maintenance-free, the electrolyte will last for the life of the battery when the vehicle is operated in a temperate climate. Your BMW center will be glad to advise in all matters concerning the battery.

Charging the battery

Only charge the battery in the vehicle via the terminals in the engine compartment with the engine off. Connections, refer to Jump starting on page 242.

Disposal

 Have old batteries disposed of by your BMW center or hand them in to a recycling center. Maintain the battery in an upright position for transport and storage. Always secure the battery against tipping over during transport. ◀

Power failure

After a temporary power loss, the functioning of some equipment may be limited and require reinitialization. Individual settings may likewise have been lost and will have to be programmed:

- ▷ Time and date
These values must be updated, refer to page 80.
- ▷ Radio
In some cases, stations may have to be stored again, refer to page 168.
- ▷ Navigation system
Operability must be waited for, refer to page 134.
- ▷ Glass roof
It may happen that the roof can only be raised. The system must be initialized. Please contact your BMW center.
- ▷ Seat and mirror memory
The positions must be stored again, refer to page 49.
- ▷ Inside rearview mirror with digital compass
The system must be calibrated, refer to page 111.

Fuses

 Never attempt to repair a blown fuse and do not replace a defective fuse with a substitute of another color or amperage rating, otherwise this could lead to a circuit overload, ultimately resulting in a fire in the vehicle. ◀



Open the cover in the glove compartment and remove it.

Spare fuses and a pair of plastic forceps are set in holders on the distributor box.

See the rear of the cover for information on fuse assignment.

Giving and receiving assistance

Emergency Request*

Conditions for an Emergency Request:

- ▶ Equipment version with full preparation package mobile phone. This equipment makes it possible to send an Emergency Request even if no mobile phone is paired with the vehicle.
- ▶ BMW Assist is activated. Activating BMW Assist, refer to page 208.
- ▶ Radio readiness is on.
- ▶ The BMW Assist system is logged on to a mobile phone network.
- ▶ The Emergency Request system is operable.

Once your service contract for BMW Assist expires, the BMW Assist system can be deactivated by a BMW center without you having to visit a workshop. Once the BMW Assist system has been deactivated, Emergency Requests are not possible. The BMW Assist system can be reactivated by a BMW center after a new contract has been signed.

Sending an Emergency Request

1. Briefly press the cover flap to open.



2. Press the SOS button for at least 2 seconds.

The LED in the button lights up. As soon as the voice connection to the BMW Assist Response Center has been established, the LED flashes.

Once the BMW Assist Response Center has received your Emergency Request, the

BMW Assist Response Center contacts you and takes further steps to help you. Even if you are unable to respond, the BMW Assist Response Center will be able to initiate further steps to assist you under certain conditions.

If the circumstances allow this, remain in the vehicle until the connection has been established. You will then be able to provide a detailed description of the situation.

If the current location of your vehicle can be determined, it will be transmitted to the BMW Assist Response Center.

If the LED is flashing but the BMW Assist Response Center cannot be heard over the hands-free system, it is possible that the hands-free system is malfunctioning. You may still be heard by the BMW Assist Response Center, however.

Under certain conditions, an Emergency Request is sent automatically immediately after a severe accident. This Automatic Collision Notification is not affected by the button being pressed.

 For technical reasons, the Emergency Request service cannot be guaranteed for the most unfavorable conditions. ◀

Roadside Assistance

The BMW Roadside Assistance is there to assist you around the clock in the event of a breakdown, including on weekends and public holidays.

The phone numbers of the Roadside Assistance in your home country can be found in the Contact brochure.

In vehicles equipped with BMW Assist, you can establish contact with BMW Roadside Assistance for breakdown assistance directly via iDrive, refer to page 204.

First aid pouch*

Some of the articles contained in the first aid pouch have a limited service life. Therefore, check the expiration dates of the contents regularly and replace any items in good time, if necessary.

Coupe



The first aid pouch is located on the right-hand side of the cargo bay in a storage area.

Convertible



The first aid pouch is located in a compartment under the front passenger's seat.

To open: press the button and fold the cover down.

To close: fold the cover back up and press it into the catch.

Warning triangle*

Coupe

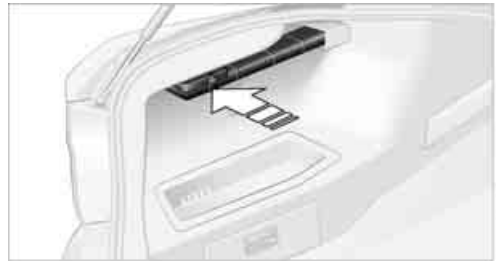

The warning triangle is located on the left-hand side of the cargo bay. Press the tab to take it out.

Convertible

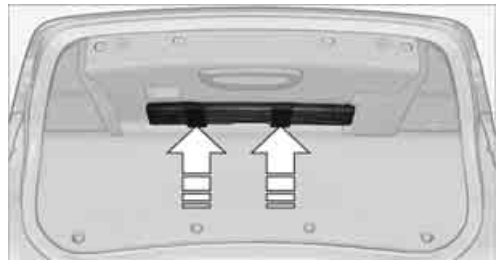

The warning triangle is located in a holder in the luggage compartment lid. Press the tabs to take it out.

Jump starting

If the car's own battery is flat, your BMW's engine can be started by connecting two jumper cables to another vehicle's battery. You can also use the same method to help start another vehicle. Only use jumper cables with fully-insulated clamp handles.

 Do not touch any electrically live parts when the engine is running, or a fatal accident may occur. Carefully adhere to the following sequence, both to prevent damage to one or both vehicles, and to guard against possible personal injuries. ◀

Preparation

1. Check whether the battery of the other vehicle has a voltage of 12 volts and approximately the same capacitance in Ah. This information can be found on the battery.
2. Switch off the engine of the assisting vehicle.
3. Switch off any consumers in both vehicles.

 There must not be any contact between the bodies of the two vehicles, otherwise there is a danger of shorting. ◀

Connecting jumper cables

 Connect the jumper cables in the correct order, so that no sparks which could cause injury occur. ◀

Your BMW has a jump-starting connection in the engine compartment which acts as the battery's positive terminal, refer also to the Engine compartment overview on page 223. The cap is marked with +.

1. Pull the cap of the BMW jump-starting connection up to remove.



2. Attach one terminal clamp of the plus/+ jumper cable to the positive terminal of the battery or a starting-aid terminal of the vehicle providing assistance.
3. Attach the second terminal clamp of the plus/+ jumper cable to the positive terminal of the battery or a starting-aid terminal of the vehicle to be started.
4. Attach one terminal clamp of the minus/- jumper cable to the negative terminal of the battery or to an engine or body ground of the assisting vehicle.

Your BMW has a special nut as body ground or negative pole.



5. Attach the second terminal clamp of the minus/- jumper cable to the negative terminal of the battery or to the engine or body ground of the vehicle to be started.

Starting the engine

1. Start the engine of the donor vehicle and allow it to run for a few minutes at slightly increased idle speed.
2. Start the engine on the other vehicle in the usual way.
If the first start attempt is not successful, wait a few minutes before another attempt in order to allow the discharged battery to recharge.
3. Let the engines run for a few minutes.
4. Disconnect the jumper cables by reversing the above connecting sequence.

If necessary, have the battery checked and recharged.

 Never use spray fluids to start the engine. ◀

Tow-starting, towing away

 Observe the applicable laws and regulations for tow-starting and towing vehicles. ◀

 Do not transport any passengers other than the driver in a vehicle that is being towed. ◀

Using a tow fitting

The screw-in tow fitting must always be carried in the car. It can be screwed in at the front or rear of the BMW.

Coupe: it is stored in the onboard tool kit underneath the cover on the right-hand side of the cargo bay, refer to page 233.

Convertible: it is stored in the onboard tool kit underneath the cargo bay floor, refer to page 233.

! Use only the tow fitting provided with the vehicle and screw it all the way in. Use the tow fitting for towing on paved roads only. Avoid lateral loading of the tow fitting, e.g. do not lift the vehicle by the tow fitting. Otherwise the tow fitting and the vehicle could be damaged. ◀

Access to screw thread

Release the cover panel in the bumper:
Press on the upper part of the cover panel.

Front



Rear

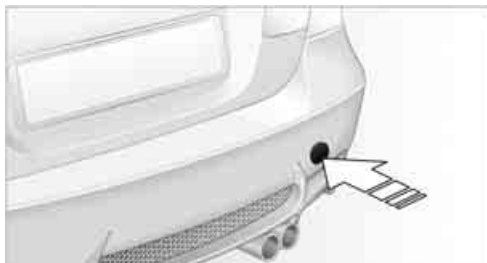

Being towed

! Make sure that the ignition is switched on, refer to page 59, otherwise the low-beam

headlamps, tail lamps, turn signal indicators and windshield wipers may be unavailable.

Power steering assistance is not available when the engine is not running. Thus, braking and steering will require increased effort. ◀

Manual transmission

Gearshift lever in neutral position.

Dual clutch transmission with Drivelogic

! Ensure that the parking lock P is not engaged as the rear wheels will otherwise be blocked.

When using the car wash function, refer to page 61, note that the parking lock P is engaged automatically after approx. 30 minutes, blocking the rear wheels.

If an electrical malfunction occurs or if towing takes longer than approx. 20 minutes, manually release the parking lock, refer to page 64. ◀

! When towing, do not exceed a maximum speed of 30 mph/50 km/h and a maximum distance of 30 miles/50 km, otherwise the transmission can be damaged. ◀

BMW recommends transporting the vehicle on a tow truck with a flat bed.

Towing methods

! Do not lift the vehicle by a tow fitting or body and chassis parts, otherwise damage may result. ◀

With a tow bar

! The towing vehicle must not be lighter than the towed vehicle, otherwise it may be impossible to maintain control. ◀

The tow fittings used should be on the same side on both vehicles. Should it prove impossible to avoid mounting the tow bar at an angle, please observe the following:

- ▷ Clearance and maneuvering capability will be sharply limited during cornering.
- ▷ The tow bar will generate lateral forces if it is attached offset.

 Attach the tow bar to the tow fittings only, as attaching it to other parts of the vehicle could result in damage. ◀

With a tow rope

When starting off in the towing vehicle, make sure that the tow rope is taut.

 To avoid jerking and the associated stresses on vehicle components when towing, always use nylon ropes or nylon straps. Attach the tow rope to the tow fittings only, as attaching it to other parts of the vehicle could result in damage. ◀

With a tow truck

Manual transmission:

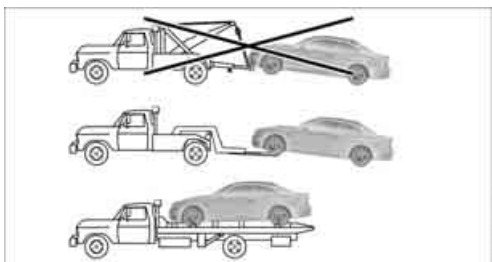

Have the BMW transported with a tow truck with a so-called lift bar or on a flat bed.

Do not tow the vehicle with just the rear axle raised as this may cause the steering to turn.

M dual clutch transmission:

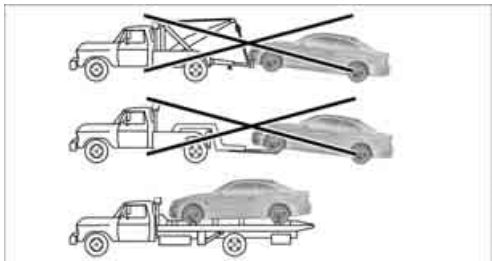

Have the BMW transported with a tow truck with a so-called lift bar or on a flat bed.

Tow-starting

If possible, do not tow-start the vehicle but jump-start the engine, refer to page 242. Vehi-

cles with a catalytic converter should only be tow-started when the engine is cold.

Manual transmission

1. Switch on hazard warning flashers, comply with local regulations.
2. Switch on the ignition, refer to page 59.
3. Shift into 3rd gear.
4. Have the vehicle tow-started with the clutch depressed and slowly release the clutch. After the engine starts, immediately depress the clutch completely again.
5. Stop at a suitable location, remove the tow bar or rope and switch off the hazard warning flashers.
6. Have the vehicle checked.

M dual clutch transmission with Drivelogic

Vehicles with an M dual clutch transmission cannot be tow-started. Jump-starting, refer to page 242.



Reference

This chapter contains technical data, short commands for the voice command system and an index that will help you find information most quickly.

Technical data

Engine data

		M3
Displacement	cu in/cm ³	244/3,999
Number of cylinders		8
Maximum power output	hp	414
at engine speed	rpm	8,300
Maximum torque	lb ft/Nm	295/400
at engine speed	rpm	3,900

Dimensions

Coupe

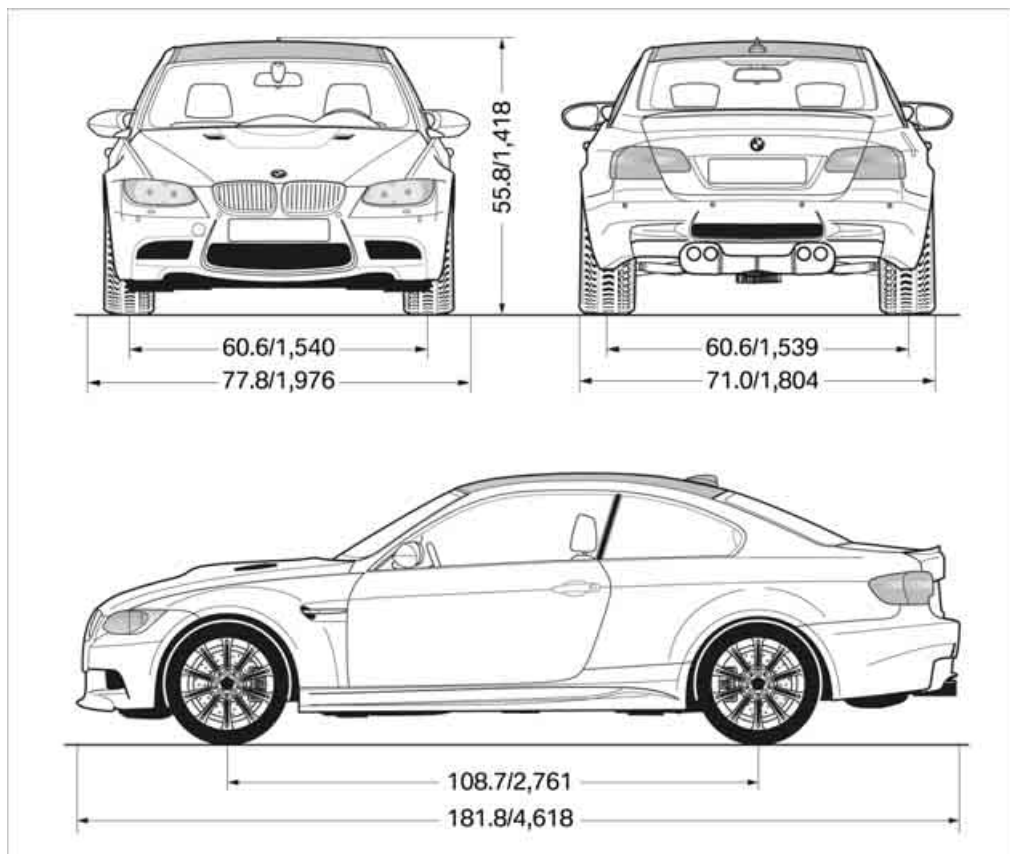

All dimensions given in inches/mm.
Smallest turning circle dia.: 38 ft 5 in/11.7 m.

Convertible

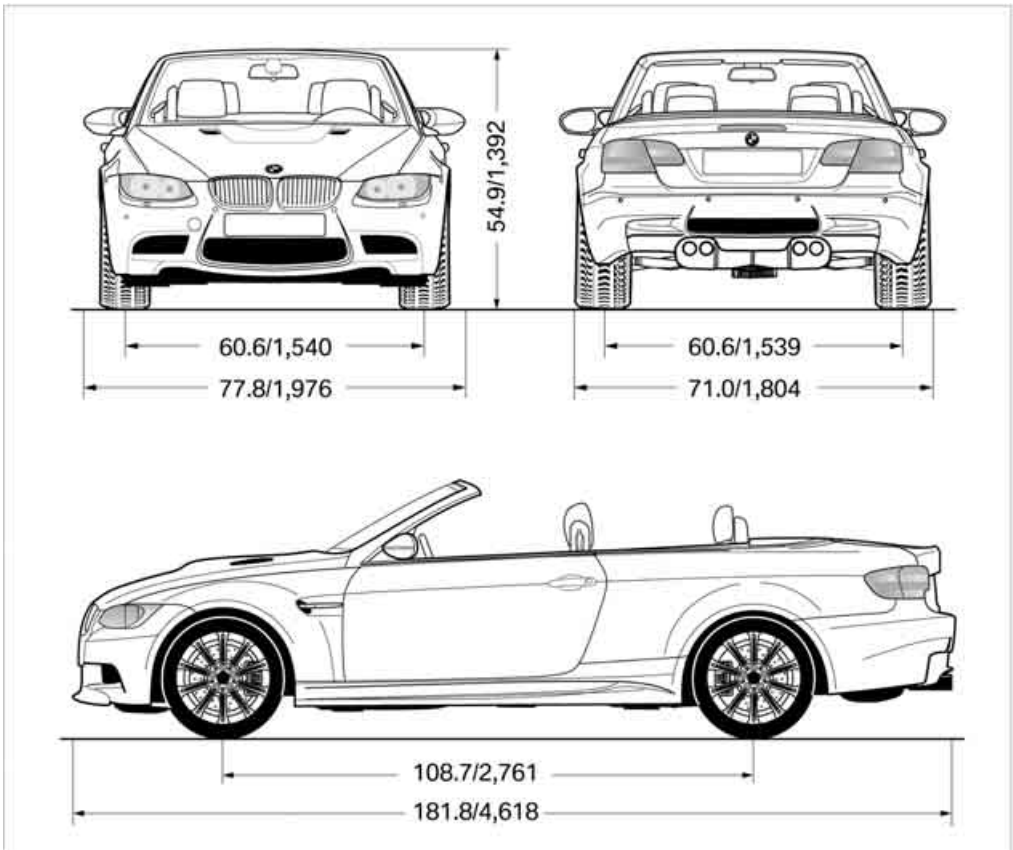

All dimensions given in inches/mm.
 Smallest turning circle dia.: 38 ft 5 in/11.7 m.

Weights

Coupe

			M3
Curb weight	lbs/kg		3,704/1,680
Approved gross weight	lbs/kg		4,586/2,080
Load	lbs/kg		882/400
Approved front axle load	lbs/kg		2,249/1,020
Approved rear axle load	lbs/kg		2,469/1,120
Approved roof load capacity	lbs/kg		165/75
Cargo bay capacity	cu ft/liters		15.2/430

Convertible

			M3
Curb weight	lbs/kg		4,145/1,880
Approved gross weight	lbs/kg		5,027/2,280
Load	lbs/kg		882/400
Approved front axle load	lbs/kg		2,337/1,060
Approved rear axle load	lbs/kg		2,800/1,270
Cargo bay capacity	cu ft/liters		7.4-12.4/210-350

Capacities

			Notes
Fuel tank	US gal/liters	approx. 16.6/63	Fuel grade: page 215
including reserve of	US gal/liters	approx. 3.3/12.5	
Window washer system			For more details: page 70
including headlamp washers	US qt/liters	approx. 4.8/4.5	

Short commands for the voice command system*

With short commands you can carry out certain functions directly, regardless of which menu

item is selected. Here are the important short commands for the voice command system.

Assistance window

Function	Command
To open assistance window 20	›Assistance window‹
To select display in the assistance window 20	›Assistance window map facing north‹, ›Assistance window map direction of travel‹, ›Assistance window arrow display‹, ›Assistance window perspective‹, ›Assistance window current position‹, ›Assistance window trip computer‹ or ›Assistance window onboard info‹
To change the scale in the assistance window 151	›Assistance window scale ... feet‹ or ›Assistance window scale ... miles‹

Communication

Function	Command
To open phone 195	›Phone‹
To dial phone number 195	›Dial number‹
To display phone book 195	›A to Z‹
To select from phone book 195	›Call ...‹ or ›Dial name‹
To display "Top 8" 195	›Top 8‹
To redial 195	›Redial‹
To display "Received calls" 195	›Received calls‹
To display "Missed calls" 195	›Missed calls‹
To display "Bluetooth" 189	›Bluetooth‹
To open BMW Assist 208	›BMW Assist‹
To open "BMW Service" services 204	›BMW Service‹
To open "BMW Contact" 197	›BMW Contact‹
To open "BMW Contact Numbers" 197	›BMW Contact numbers‹
To open "Roadside Assistance" 204	›Roadside Assistance‹

Navigation

Function	Command
To open navigation 136	›Navigation‹
To display current position 157	›Current position‹
To open "Enter address" 136	›Enter address‹
To open "New destination" 136	›New destination‹
To display "Input map" 141	›Input map‹
To open "Information" 142	›Info menu‹
To display address book 144	›Address book‹ or ›From address book‹
To display destination list 143	›Destination list‹
To switch on destination guidance 149	›Start guidance‹
To switch off destination guidance 149	›Stop guidance‹
To display route criteria 147	›Route preference‹
To switch on voice instructions 152	›Navigation info on‹
To switch off voice instructions 152	›Navigation info off‹
To repeat voice instructions 153	›Repeat navigation info‹
To show arrow display 150	›Arrow display‹
To display map 151	›Map‹, ›Map facing north‹, ›Map direction of travel‹ or ›Perspective‹
To open route 153	›Route menu‹
To open "New route" 153	›New route‹
To change scale 151	›Scale ... miles‹ or ›Scale ... feet‹
To display towns/cities and streets along the route 152	›Route list‹

Onboard info

Function	Command
To open "Car Data" 75	›Car Data‹
To display computer 75	›Onboard info‹
To display trip computer 76	›Trip computer‹
To open speed limit 84	›Limit‹
To open stopwatch 85	›Stopwatch‹
To activate road-speed limit 84	›Limit on‹
To deactivate road-speed limit 84	›Limit off‹

Entertainment

Function	Command
To tone control 163	›Audio‹
To switch on radio 166	›Radio on‹, ›FM‹ or ›AM‹
To open "FM" 166	›FM menu‹
To open "AM" 166	›AM menu‹
To open "All stations" 166	›FM All stations‹
To select radio station 166	›Station‹ e.g. ›Station WNYC‹ or ›Choose station‹
To open "Presets" 166	›FM presets‹ or ›AM presets‹
To open "Manual" 167	›FM manual‹ or ›AM manual‹ or ›Choose frequency‹, ›Frequency ... Megahertz‹
To select preset radio station 168	›Preset ...‹ e.g. ›Preset 1‹
To open strongest radio stations 167	›AM Autostore‹
To open "SAT" 173	›SAT radio menu‹
To switch on satellite radio 173	›SAT radio‹
To open "Presets" of the satellite radio 174	›SAT radio presets‹
To open "All channels" of the satellite radio 173	›SAT radio all channels‹
To open "Categories" of the satellite radio 173	›SAT radio categories‹
To open CD player 175	›CD menu‹
To switch on CD player 175	›CD‹
To open CD changer 175	›CD changer menu‹
To switch on CD changer 175	›CD changer‹
To select a CD in the CD changer 175	›CD 1...6‹
To select track 176	›CD track ...‹
To select a CD and track in the CD changer 176	›CD 1...6 track ...‹
To select track 176	›Track ...‹
To open DVD 175	›DVD player menu‹
To switch on DVD 175	›DVD player‹
To select music track on DVD 176	›DVD track ...‹
To start sound output for external audio device 181	›Audio Aux on‹

Climate

Function	Command
To open "Vent settings" 104	›Vent settings‹
To open "Automatic programs" 105	›Automatic programs‹

i menu

Function	Command
To open the i menu	›Settings menu‹
"Display off" 21	›Display off‹
To open "Info sources"	›Info sources‹
To open "Settings"	›Settings‹
To open "Door locks", 32 29	›Door locks‹
To open "Steering wheel buttons" 53	›Steering wheel buttons‹
To open MDrive 54	›MDrive‹
To open "Lighting" 68	›Lighting‹
To open "BMW Service" 204	›BMW Service‹
To open "Service requirements", 203 79	›Service requirements‹
To open "Service", 203 79	›Service‹
To display "Check Control messages" 82	›Check Control messages‹
To set brightness of Control Display 86	›Brightness‹
To open "Units" 73	›Units‹
To open "Language", 152 85	›Languages‹
To open "Time" 80	›Time‹
To open "Date" 82	›Date‹
To open "PDC" 87	›PDC‹
To open "FTM" 91	›FTM‹
To open "TPM" 93	›TPM‹

Everything from A-Z

Index

"..." Identifies Control Display texts used to select individual functions and refers you to the page where these texts can be found.

A

- ABS Antilock Brake System [88](#)
- Acceleration assistant, refer to Launch Control [67](#)
- Accident, refer to Sending an Emergency Request [241](#)
- Activated-charcoal filter for automatic climate control [107](#)
- "Activation time" [108](#)
- Adaptive Head Light [100](#)
- "Add digits" on the mobile phone [196](#)
- Additives
 - coolant [226](#)
- "Address book" in navigation [144](#)
- Address for navigation
 - deleting [146](#)
 - entering [136](#), [144](#)
 - selecting [145](#)
 - storing [144](#)
 - storing current position [145](#)
- "Add to destination list" [139](#)
- Adjusting temperature inside the car, refer to Automatic climate control [104](#)
- Adjusting the thigh support [46](#)
- Adjusting the tone during audio operation, refer to Tone control [163](#)
- Airbags [95](#)
 - indicator/warning lamp [97](#)
 - sitting safely [45](#)
- Air conditioning mode
 - automatic climate control [104](#)
 - ventilation [106](#)
- Air distribution
 - automatic [105](#)
 - individual [104](#)
- Air flow rate [105](#)
- Airing, refer to Ventilation [106](#)
- Air pressure, refer to Tire inflation pressure [216](#)
- Air recirculation, refer to Recirculated-air mode [105](#)
- "Air recirculation on / off" [53](#)
- Air supply
 - automatic climate control [104](#)
 - ventilation [106](#)
- Air vents [103](#)
- AKI, refer to Fuel specifications [215](#)
- Alarm system [35](#)
 - avoiding unintentional alarms [36](#)
 - interior motion sensor [36](#)
 - switching off an alarm [35](#)
 - tilt alarm sensor [36](#)
- "All channels" for satellite radio [173](#)
- All-season tires, refer to Winter tires [220](#)
- "All stations", displaying with the radio [166](#)
- "AM", waveband [162](#), [166](#)
- Ambient air, refer to Recirculated-air mode [105](#)
- Antenna for mobile phone [188](#)
- Antifreeze
 - coolant [226](#)
 - washer fluid [70](#)
- Antilock Brake System
 - ABS [88](#)
- Anti-theft alarm system, refer to Alarm system [35](#)
- Anti-theft system [29](#)
- Approved axle loads, refer to Weights [251](#)
- Approved gross vehicle weight, refer to Weights [251](#)
- Armrest, refer to Center armrest [113](#)
- Arrival time, refer to Computer [75](#)
- Arrival time, refer to Starting destination guidance [149](#)
- Arrow display for navigation [150](#)
- "Arrow display" in navigation [150](#)
- Ashtray
 - front [115](#)
 - rear [115](#)
- Assist [203](#)
- Assistance systems, refer to Driving stability control systems [88](#)
- Assistance window [20](#)
 - refer to iDrive [20](#)
- "Assist profile" [209](#)
- AUC Automatic recirculated-air control [105](#)
- "Audio" [165](#), [169](#)
- Audio [162](#)
 - controls [162](#)
 - switching on/off [162](#)
 - tone control [163](#)
 - volume [163](#)
- "Audio", refer to Tone control [163](#)
- Audio device, external [113](#)

Automatic
– air distribution [105](#)
– air flow rate [105](#)
– BMW Teleservice Call [205](#)
– cruise control [70](#)
– headlamp control [99](#)
– storing of stations [167](#)
Automatic car washes [229](#)
Automatic climate control [103](#)
– automatic air distribution [105](#)
– settings via iDrive [104](#)
Automatic curb monitor [52](#)
"Automatic programs" with automatic climate control [105](#)
Automatic recirculated-air control AUC [105](#)
Automatic station search [167](#)
Automatic transmission with Steptronic
– towing [243](#)
– tow-starting [243](#)
"Automatic ventilation" [107](#)
AUTO program for automatic climate control [105](#)
"Auto Request" [205](#)
"Autostore"
– on the radio [168](#)
"AUX" [162](#), [181](#), [183](#)
– AUX-In port [181](#)
– USB-audio interface [182](#)
AUX-In port [181](#)
Average fuel consumption [75](#)
– setting the units [77](#)
"Avoid ferries" in navigation [147](#)
"Avoid highways" in navigation [147](#)
Avoid highways in navigation [147](#)
Avoiding unintentional alarms [36](#)
"Avoid tollroads" in navigation [147](#)
Axle loads, refer to Weights [251](#)
"A - Z" [195](#), [196](#)

B

Backrest contour, refer to Lumbar support [46](#)
Backrests, refer to Seat adjustment [46](#)
Backrest width adjustment [47](#)
Back seats
– refer to Rear seats [48](#)
Backup lamps
– replacing bulb [235](#)
Backup lamps, refer to Tail lamps [235](#)
Bag holder [117](#)
Balance, tone control [163](#)
Band-aids, refer to First-aid pouch [242](#)
Bar, refer to Towing methods [244](#)
Base plate for telephone or mobile phone
– refer to Snap-in adapter in the center armrest storage compartment [113](#)
Bass, tone control [163](#)
Bass sounds, refer to Treble and bass [163](#)
Battery [239](#)
– charging [239](#)
– disposal [38](#), [239](#)
– jump starting [242](#)
– remote control [248](#)
– temporary power failure [239](#)
Battery renewal
– remote control [38](#)
– remote control for vehicle [38](#)
Being towed [244](#)
Belt hand-over [51](#)
Belts, refer to Safety belts [50](#)
Belt tensioner, refer to Safety belts [50](#)
Beverage holders, refer to Cup holders [114](#)
Blinds, refer to Roller sun blinds [112](#)
Blower, refer to Air flow rate [105](#)
Bluetooth, refer to separate Owner's Manual

BMW
– car shampoo [231](#)
"BMW Assist" [204](#), [205](#), [206](#), [207](#)
BMW Assist
– activating [208](#)
– Concierge service [207](#)
– contacting BMW Customer Relations [206](#)
– Roadside Assistance [204](#)
– services offered [203](#)
– TeleServices [205](#)
"BMW Contact" [198](#)
"BMW Contact Numbers" [198](#)
BMW Homepage [4](#)
BMW Maintenance System [227](#)
"BMW Service settings" [209](#)
BMW Teleservice Call
– automatic [205](#)
– manual [205](#)
BMW TeleServices [205](#)
– displaying [206](#)
– updating [206](#)
BMW webpage [4](#)
Bottle holders, refer to Cup holders [114](#)
Brake assist [88](#)
Brake fluid, refer to Service requirements [78](#)
Brake Force Display [95](#)
– bulb change [236](#)
Brake lamps
– replacing bulb [235](#)
– two-stage [95](#)
Brake pads [124](#)
– breaking in [124](#)
Brake rotors [125](#)
– brakes [124](#)
– breaking in [124](#)
Brakes
– ABS [88](#)
– BMW Maintenance System [227](#)
– breaking in [124](#)
– parking brake [61](#)
– service requirements [78](#)

Brakes, refer to Braking safely [125](#)
 Brake system [124](#)
 – BMW Maintenance System [227](#)
 – breaking in [124](#)
 – disc brakes [125](#)
 Breakdown services, refer to Roadside Assistance [241](#)
 Breaking in the clutch [124](#)
 Breaking in the differential, refer to Engine and differential [124](#)
 Break-in period [124](#)
 Brightness of the Control Display [86](#)
 "Brightness" on the Control Display [86](#)
 Bulb changing, refer to Lamps and bulbs [233](#)
 Button for starting the engine, refer to Start/stop button [59](#)
 Buttons on the steering wheel [11](#)

C

California Proposition 65 warning [6](#)
 "Call" [196](#), [207](#)
 Call
 – accepting [194](#)
 – displaying accepted [196](#)
 – ending [195](#)
 – missed [196](#)
 – starting [195](#)
 Calling
 – from phone book [195](#)
 – from Top 8 list [196](#)
 – redialing [196](#)
 Can holders, refer to Cup holders [114](#)
 Capacities [251](#)
 Capacity of the cargo bay [251](#)
 Car battery, refer to Vehicle battery [239](#)
 Car care, refer to Care [229](#)
 "Car Data" [75](#)

Care [229](#)
 – automatic car washes [229](#)
 – care products [229](#)
 – carpets [231](#)
 – CD/DVD drives [232](#)
 – chrome parts [230](#)
 – displays [231](#)
 – exterior [229](#)
 – fine wood parts [231](#)
 – headlamps [230](#)
 – high-pressure washer [229](#)
 – interior [231](#)
 – leather [231](#)
 – light-alloy wheels [231](#)
 – paintwork [230](#)
 – plastic parts [231](#)
 – retractable hardtop [230](#)
 – rubber seals [230](#)
 – safety belts [231](#)
 – sensors and cameras [231](#)
 – upholstery and cloth trim [231](#)
 – washing the car manually [230](#)
 – windows [230](#)
 – wiper blades [230](#)
 Cargo, securing [127](#)
 Cargo bay
 – capacity [251](#)
 – convenient access [37](#)
 – folding up the floor panel [118](#)
 – lamp, refer to Interior lamps [102](#)
 – opening from inside [33](#)
 – opening from outside [33](#)
 Cargo loading
 – securing cargo [127](#)
 – stowing cargo [127](#)
 – vehicle [126](#)
 Car jack
 – jacking points [239](#)
 Car key, refer to Remote control [28](#)

Car phone [188](#)
 – installation location, refer to Center armrest [113](#)
 – refer to Mobile phone [188](#)
 – refer to separate Owner's Manual
 Car radio, refer to Radio [166](#)
 Car shampoo [231](#)
 Car wash
 – before driving into [61](#)
 Catalytic converter, refer to Hot exhaust system [124](#)
 "Categories" for satellite radio [173](#)
 CBS Condition Based Service [227](#)
 "CD" [162](#), [175](#)
 CD changer [175](#)
 – compressed audio files [175](#)
 – controls [162](#)
 – fast forward/reverse [179](#)
 – installation location [179](#)
 – playing a track [177](#)
 – random order [178](#)
 – repeating a track [178](#)
 – selecting a CD [175](#)
 – selecting a track [176](#)
 – switching on/off [162](#)
 – tone control [163](#)
 – volume [163](#)
 CD player [175](#)
 – compressed audio files [175](#)
 – controls [162](#)
 – fast forward/reverse [179](#)
 – playing a track [177](#)
 – random order [178](#)
 – repeating a track [178](#)
 – selecting a track [176](#)
 – switching on/off [162](#)
 – tone control [163](#)
 – volume [163](#)
 Center armrest [113](#)
 Center brake lamp
 – replacing bulb [237](#)
 Center console, refer to Around the center console [14](#)
 "Central locking" [30](#)

- Central locking
 - from inside [32](#)
 - from outside [29](#)
- Central locking system [29](#)
 - convenient access [36](#)
 - hotel function [34](#)
- Changes, technical, refer to
 - For your own safety [5](#)
- Changing bulbs, refer to
 - Lamps and bulbs [233](#)
- Changing the language on the Control Display [85](#)
- Changing the measurement units on the Control Display [77](#)
- Changing wheels [239](#)
- Chassis number, refer to
 - Engine compartment [223](#)
- Check Control [83](#)
- "Check Control messages" [84](#)
- Child-restraint fixing system LATCH [58](#)
- Child-restraint systems [57](#)
- Child seats, refer to
 - Transporting children safely [57](#)
- Chrome parts [231](#)
- Chrome polish [231](#)
- Cigarette lighter, refer to
 - Lighter [115](#)
- Cleaning headlamps [70](#)
 - washer fluid [70](#)
- Cleaning your BMW, refer to
 - Care [229](#)
- "Climate" [104](#)
- Clock [73](#)
 - 12h/24h format [82](#)
 - setting time [80](#)
- Closing
 - from inside [32](#)
 - from outside [29](#)
- Clothes hooks [114](#)
- Cockpit [10](#)
- Cold start, refer to Starting the engine [60](#)
- Combined instrument, refer to Instrument cluster [12](#)
- Comfort access, refer to
 - Convenient access [36](#)
- Comfort area, refer to Around the center console [14](#)
- "Comfort" with EDC [90](#)
- "Communication" [194](#), [204](#), [205](#), [206](#), [207](#)
- Compact disc, refer to
 - CD changer [175](#)
 - CD player [175](#)
- Compartment for remote control, refer to Ignition lock [59](#)
- Compass [111](#)
- Computer [74](#)
 - displays on Control Display [75](#)
 - hour signal [81](#)
- Computer, refer to iDrive [16](#)
- "Concert hall" for Tone control [164](#)
- "Concierge" [207](#)
- Concierge service [207](#)
- Condensation, refer to When the vehicle is parked [126](#)
- Condition Based Service CBS [227](#)
- Configuring settings, refer to Personal Profile [28](#)
- Confirmation signals for locking/unlocking the vehicle [31](#)
- Connecting vacuum cleaner, refer to Connecting electrical appliances [115](#)
- Consumption, refer to
 - Average consumption [75](#)
- Consumption indicator, refer to Average consumption [75](#)
- "Continue guidance to destination?" [150](#)
- Control Center, refer to iDrive [16](#)
- Control Display
 - brightness [86](#)
 - changing the language [85](#)
 - switching off/on [21](#)
- Control Display, refer to iDrive [16](#)
- Controller, refer to iDrive [16](#)
- Controls and displays [10](#)
- Control unit, refer to iDrive [16](#)
- Convenient access [36](#)
 - replacing the battery [38](#)
- Convenient loading in convertible [31](#)
- Convenient operation
 - glass roof [30](#)
 - glass roof with convenient access [37](#)
 - retractable hardtop [30](#)
 - windows [30](#)
 - windows with convenient access [37](#)
- Convertible
 - bag holder [117](#)
 - convenient loading [31](#)
 - enlarging cargo bay [116](#)
 - folding down rear backrest [117](#)
 - retractable hardtop [41](#)
 - rollover protection system [97](#)
 - securing cargo [127](#)
- Coolant [226](#)
 - checking level [226](#)
- Coolant temperature [74](#)
- Cooling, maximum [105](#)
- Cooling fluid, refer to
 - Coolant [226](#)
- Cooling system, refer to
 - Coolant [226](#)
- Copyright [2](#)
- Corner-illuminating lamps, refer to Adaptive Head Light [100](#)
- Cornering lamps, refer to Adaptive Head Light [100](#)
- Correct tires [220](#)
- Courtesy lamps, refer to
 - Interior lamps [102](#)
- Cross-hairs in navigation [141](#)
- Cruise control [70](#)
- Cruising range [75](#)
- Cup holders [114](#)
- Curb weight, refer to
 - Weights [251](#)
- "Current position" [157](#)

Current position
 – displaying [157](#)
 – entering [145](#)
 – storing [145](#)
 "Customer
 Relations" [198](#), [206](#)

D

Dashboard, refer to
 Cockpit [10](#)

Dashboard, refer to
 Instrument cluster [12](#)

Dashboard lighting, refer to
 Instrument lighting [101](#)

Data, technical [248](#)

– dimensions [249](#)

– engine [248](#)

– weights [251](#)

"Date" [82](#)

Date

– setting [82](#)

– setting format [82](#)

"Date format" [82](#)

"Daytime running lamps" [100](#)

Daytime running lamps [100](#)

"Deactivated" [50](#)

Deactivating front passenger
 airbags [96](#)

Deadlocking, refer to

Locking [30](#)

Defect

– door lock [32](#)

– fuel filler door [214](#)

– glass roof [40](#)

"Delete address book" in
 navigation [146](#)

"Delete all numbers" on the
 mobile phone [197](#)

"Delete data" in
 navigation [146](#)

"Delete" for mobile
 phone [197](#)

Destination address

– deleting [146](#)

– entering [136](#), [140](#)

Destination for navigation

– destination list [143](#)

– entry [136](#)

– home address [146](#)

– manual entry [136](#), [140](#)

– selecting from address
 book [145](#)

– selecting using
 information [142](#)

– selecting via language [140](#)

– selecting via map [141](#)

– storing [144](#)

Destination guidance [149](#)

– canceling voice
 instructions [53](#)

– changing specified
 route [147](#)

– displaying route [150](#)

– distance and arrival [149](#)

– starting [149](#)

– terminating/continuing [149](#)

– voice instructions [152](#)

– volume of voice
 instructions [153](#)

Destination list for navigation
 system [143](#)

Destinations recently driven
 to [143](#)

"Details" for audio mode [183](#)

"Dial" for mobile phone [195](#)

"Dial number" [195](#)

Digital clock [73](#)

Digital compass [111](#)

Digital radio, refer to High
 Definition Radio [169](#)

Digital Versatile Disc, refer to
 – Drive for navigation DVD [162](#)

Dimensions [249](#)

Directional indicators, refer to
 Turn signals [68](#)

Direction instructions, refer to
 Voice instructions [152](#)

Directory for navigation, refer
 to Address book [144](#)

Displacement, refer to Engine
 data [248](#)

Display, refer to iDrive
 controls [16](#)

Display lighting, refer to
 Instrument lighting [101](#)

"Display off" [21](#)

Displays

– on the Control Display [16](#)

Displays, refer to Instrument
 cluster [12](#)

Displays and controls [10](#)

Disposal

– coolant [226](#)

– remote control battery [38](#)

– vehicle battery [239](#)

Distance remaining to service,
 refer to Service
 requirements [78](#)

"Distance to dest." [76](#)

Distance warning, refer to
 Park Distance Control
 PDC [87](#)

Door key, refer to Remote
 control [28](#)

Door lock [32](#)

"Door locks" [30](#), [31](#), [32](#), [79](#)

Doors, emergency
 operation [32](#)

DOT Quality Grades [218](#)

Draft-free ventilation [107](#)

Drinks holders, refer to Cup
 holders [114](#)

Drive for navigation DVD [162](#)

Drivelogic [65](#)

Drive mode [63](#)

Drive-off assistance, refer to
 Dynamic Stability Control
 DSC [88](#)

Drive-off assistant [90](#)

Drive position, engaging, refer
 to Selector lever
 positions [62](#)

Drive programs, refer to
 Drivelogic [65](#)

Driving around a traffic
 congestion [156](#)

Driving lamps, refer to Parking
 lamps/low beams [99](#)

Driving notes [124](#)

Driving off on hills, refer to
 Drive-off assistant [90](#)

Driving route, refer to
 Displaying route [150](#)
Driving stability control
 systems [88](#)
Driving through water [125](#)
Driving tips, refer to Driving
 notes [124](#)
Dry air, refer to Cooling
 function [106](#)
"DSC" [54](#), [89](#)
DSC Dynamic Stability
 Control [88](#)
DVD
 – drive for navigation DVD [162](#)
DVD for navigation [134](#)
"Dynamic route" in
 navigation [147](#)
Dynamic Stability Control
 DSC
 – indicator/warning lamp [90](#)
 – M Dynamic Mode MDM [88](#)

E

"EDC" [54](#), [55](#)
EDC, refer to Electronic
 Damper Control [90](#)
Eject button, refer to Buttons
 on the CD player [162](#)
Electric
 – seat adjustment [46](#)
Electrical malfunction
 – door lock [32](#)
 – driver's door [32](#)
 – fuel filler door [214](#)
 – glass roof [40](#)
 – luggage compartment lid [33](#)
 – M dual clutch transmission
 with Drivelogic [64](#)
Electric seat [46](#)
Electric seat adjustment [46](#)
Electric steering wheel lock
 – with convenient access [37](#)
Electronic brake-force
 distribution [88](#)

Electronic Damper Control
 EDC [90](#)
 – "Comfort" [90](#)
 – "Normal" [90](#)
 – "Sport" [90](#)
Electronic oil level check [223](#)
Electronic Stability Program
 ESP, refer to Dynamic
 Stability Control DSC [88](#)
Emergency operation
 – fuel filler door, manual
 release [214](#)
Emergency operation, refer to
 Closing manually
 – glass roof [40](#)
Emergency operation, refer to
 Manual operation
 – door lock [32](#)
Emergency release
 – luggage compartment lid
 from inside [34](#)
Emergency Request [241](#)
Emergency services, refer to
 Roadside Assistance [241](#)
"Enabled services" [208](#)
"Enabled TeleServices" [206](#)
"End call" [195](#)
Engine
 – breaking in [124](#)
 – data [248](#)
 – overheated, refer to Coolant
 temperature [74](#)
 – speed [248](#)
 – starting [60](#)
 – starting, convenient
 access [36](#)
 – switching off [60](#)
Engine compartment [223](#)
Engine coolant, refer to
 Coolant [226](#)
Engine oil
 – adding [225](#)
 – BMW Maintenance
 System [227](#)
 – checking level [223](#)
 – intervals between changes,
 refer to Service
 requirements [78](#)
 – possible displays [224](#)

"Engine oil level" [225](#)
Engine output, refer to Engine
 data [248](#)
Engine speed, refer to Engine
 data [248](#)
Engine starting, refer to
 Starting the engine [60](#)
"Enter address" [137](#)
Entering a destination [137](#)
Entering a destination
 country [137](#)
Entering a house number or
 intersection [139](#)
Entering an intersection [138](#)
Entering a street [138](#)
"Entertainment" [162](#)
Entry lamps, refer to Interior
 lamps [102](#)
"Equalizer", refer to Tone
 control [165](#)
Equalizer, refer to Tone
 control [164](#)
Error messages, refer to
 Check Control [83](#)
"ESN" [172](#)
Event data recorders [228](#)
Exhaust system, refer to Hot
 exhaust system [124](#)
Exterior mirrors [51](#)
 – adjusting [51](#)
 – automatic dimming
 feature [52](#)
 – automatic heating [52](#)
 – folding in and out [51](#)
External audio device [113](#)
External audio device, refer to
 AUX-In port [181](#)
Eyes
 – for tow-starting and towing
 away [244](#)
 – for tying down loads [127](#)

F

Fader, tone control [163](#)
Failure messages, refer to
 Check Control [83](#)
Failure of an electrical
 consumer [239](#)

- False alarm
 - avoiding unintentional alarm [36](#)
 - switching off an alarm [35](#)
 - Fastening safety belts, refer to Safety belts [50](#)
 - Fastest route for navigation [147](#)
 - Fast forward
 - CD changer [179](#)
 - CD player [179](#)
 - "Fast route" in navigation [147](#)
 - Filter
 - refer to Microfilter/activated-charcoal filter for automatic climate control [107](#)
 - First aid pouch [242](#)
 - Fixture for remote control, refer to Ignition lock [59](#)
 - Flashlight, refer to LED hand lamp [113](#)
 - Flash when locking/unlocking [31](#)
 - Flat tire
 - Tire Pressure Monitor TPM [92](#)
 - Flat tire, repairing [237](#)
 - Flat Tire Monitor FTM [90](#)
 - indicating a flat tire [92](#)
 - indicator/warning lamp [92](#)
 - initializing the system [91](#)
 - malfunction [92](#)
 - snow chains [91](#), [221](#)
 - system limits [91](#)
 - Flat tires, refer to Tire condition [219](#)
 - Fluid reservoir, refer to Washer fluid reservoir [70](#)
 - "FM", waveband [162](#), [166](#)
 - FM, waveband [166](#)
 - Folding in the mirrors, before driving into a car wash [51](#)
 - Folding up the floor panel [118](#)
 - Footbrake, refer to Braking safely [125](#)
 - Footwell lamps, refer to Interior lamps [102](#)
 - Forward position, engaging, refer to Selector lever positions [62](#)
 - For your own safety [5](#)
 - Frequency, selecting manually [167](#)
 - Front airbags [95](#)
 - FTM, refer to Flat Tire Monitor [90](#)
 - Fuel [215](#)
 - average consumption [75](#)
 - gauge [74](#)
 - high-quality brands [215](#)
 - quality [215](#)
 - specifications [215](#)
 - tank contents, refer to Capacities [251](#)
 - Fuel clock, refer to Fuel gauge [74](#)
 - Fuel display, refer to Fuel gauge [74](#)
 - Fuel filler door [214](#)
 - releasing in the event of electrical malfunction [214](#)
 - Fuses [239](#)
- ## G
- Garage door opener, refer to Integrated universal remote control [109](#)
 - Gasoline
 - refer to Average consumption [75](#)
 - Gasoline, refer to Required fuel [215](#)
 - Gasoline display, refer to Fuel gauge [74](#)
 - Gasoline engine, checking engine oil level [223](#)
 - Gear
 - neutral [63](#)
 - Gear change [64](#)
 - Gear display, refer to Displays in the instrument cluster [64](#)
 - Gearshift lever
 - manual transmission [61](#)
 - Gearshifts
 - manual transmission [61](#)
 - General driving notes [124](#)
 - Glass roof, electric [39](#)
 - closing after electrical malfunction [40](#)
 - convenient operation [30](#), [32](#)
 - initializing [40](#)
 - opening, closing [39](#)
 - operation with convenient access [37](#)
 - pinch protection system [40](#)
 - power failure [40](#)
 - raising [39](#)
 - remote control [30](#)
 - Glove compartment [112](#)
 - LED hand lamp [113](#)
 - GPS navigation, refer to Navigation system [134](#)
 - Grills [103](#)
 - Gross vehicle weight, refer to Weights [251](#)
- ## H
- Handbrake, refer to Parking brake [61](#)
 - Hand lamp, refer to LED hand lamp [113](#)
 - Hands-free system [14](#)
 - Hazard warning flashers [14](#)
 - "HD radio" [169](#)
 - HD radio, refer to High Definition Radio [169](#)
 - Head airbags [95](#)
 - Headlamp control, automatic [99](#)
 - Headlamp flasher [68](#)
 - indicator lamp [11](#), [13](#)
 - Head restraints [47](#)
 - front, removing [47](#)
 - rear, removing [48](#)
 - sitting safely [45](#)
 - Heated
 - mirrors [52](#)
 - rear window [106](#)
 - seats [48](#)

- Heating
 - mirrors [52](#)
 - rear window [106](#)
 - residual heat [106](#)
 - seats [48](#)
- Heating and ventilation, refer to Climate [103](#)
- Heating while at a standstill, refer to Using residual heat [106](#)
- Heavy loads, refer to Stowing cargo [127](#)
- Height, refer to Dimensions [249](#)
- Height adjustment
 - seats [46](#)
 - steering wheel [52](#)
- High beams [101](#)
- headlamp flasher [101](#)
- indicator lamp [13](#)
- High Definition Radio [169](#)
- High-pressure washer [229](#), [230](#)
- High water, refer to Driving through water [125](#)
- Highways, refer to Route criteria [147](#)
- Hills [125](#)
- Holders for cups [114](#)
- Home address [146](#)
- "Home address" in navigation [147](#)
- Homepage BMW [4](#)
- Hood [222](#)
- Hooks for shopping bags [117](#)
- Horn [10](#), [11](#)
- Hotel function [34](#)
- Hot exhaust system [124](#)
- "Hour memo" [82](#)
- "House number" in destination entry [139](#)
- Hydraulic brake assist, refer to Brake assist [88](#)
- Hydroplaning [125](#)
- I
- IBOC, refer to High Definition Radio [169](#)
- Ice warning, refer to Outside temperature warning [73](#)
- ID3 tag, refer to Information about the track [177](#)
- Identification marks, tire coding [218](#)
- iDrive [16](#)
 - adjusting brightness [86](#)
 - assistance window [20](#)
 - automatic climate control [104](#)
 - changing language [85](#)
 - changing units of measure and display format [77](#)
 - confirming selection or entry [19](#)
 - controls [16](#)
 - displays, menus [17](#)
 - menu guidance [17](#)
 - operating principle [16](#)
 - overview [16](#)
 - selecting a menu item [19](#)
 - setting the date and time [80](#)
 - start menu [17](#)
 - status information [20](#)
 - switching menu pages [19](#)
 - symbols [18](#)
- iDrive operating principle [16](#)
- Ignition [59](#)
 - switched off [60](#)
 - switched on [59](#)
- Ignition key, refer to Remote control [28](#)
- Ignition key position 1, refer to Radio readiness [59](#)
- Ignition key position 2, refer to Ignition on [59](#)
- Ignition lock [59](#)
- i menu [18](#)
- Imprint [2](#)
- Indicator and warning lamps [13](#)
 - MDrive [55](#)
 - M Dynamic Mode [89](#)
 - Tire Pressure Monitor TPM [94](#)
- Individual air distribution [104](#)
- Inflation pressure, refer to Tire inflation pressure [216](#)
- Inflation pressure monitoring, refer to Tire Pressure Monitor TPM [92](#)
- Information
 - on another location [142](#)
 - on country [142](#)
 - on current position [142](#)
 - on destination location [142](#)
- Information menu, refer to i menu [18](#)
- "Information on destination" [144](#)
- "Info sources" [79](#)
- Initializing
 - after power failure [239](#)
 - compass, refer to Digital compass, calibrating [111](#)
 - Flat Tire Monitor FTM [91](#)
 - glass roof [40](#)
 - "Input map" [141](#)
- Installation location
 - CD changer [179](#)
 - navigation DVD drive [134](#)
 - telephone [113](#)
- Instructions for navigation system, refer to Voice instructions [152](#)
- Instrument cluster [12](#)
- Instrument lighting [101](#)
- Instrument panel, refer to Cockpit [10](#)
- Integrated key [28](#)
- Integrated universal remote control [109](#)
- Interesting destination for navigation [142](#)
- "Interim time" [85](#)
- Interior lamps [102](#)
 - remote control [31](#)
- Interior motion sensor [36](#)
- Interior rearview mirror [52](#)
 - automatic dimming feature [52](#)
 - compass [111](#)
- Intermittent mode of the wipers [69](#)

J

Jacking points [239](#)
 Joystick, refer to iDrive [16](#)
 Jumping, refer to Jump starting [242](#)
 Jump starting [242](#)

K

Key, refer to Remote control [28](#)
 Keyless go, refer to Convenient access [36](#)
 Keyless opening and closing, refer to Convenient access [36](#)
 Key Memory, refer to Personal Profile [28](#)
 Knock control [215](#)

L

Lamps
 – automatic headlamp control [99](#)
 – parking lamps/low beams [99](#)
 Lamps and bulbs, replacing bulbs [233](#)
 "Language / Units" [77](#)
 "Language / Units" in navigation [135](#), [152](#)
 "Language" on the Control Display [85](#)
 "Languages" in navigation [135](#), [152](#)
 Lap-and-shoulder belt, refer to Safety belts [50](#)
 Lashing eyes, refer to Securing cargo [127](#)
 Last destinations, refer to Destination list [143](#)
 "Last seat pos." [50](#)
 LATCH child-restraint fixing system [58](#)
 Launch Control [67](#)
 Leather care [231](#)
 LED hand lamp [113](#)
 LED light-emitting diodes [234](#)

Length, refer to Dimensions [249](#)
 License plate lamp, replacing bulb [237](#)
 Light-alloy wheels [231](#)
 Light-emitting diodes LED [234](#)
 Lighter [115](#)
 – connecting electrical appliances [115](#)
 "Lighting" [69](#)
 Lighting
 – instruments [101](#)
 – lamps and bulbs [233](#)
 – vehicle, refer to Lamps [99](#)
 Light switch [99](#)
 "Limit" [85](#)
 Limit, refer to Speed limit [84](#)
 Load securing equipment, refer to Securing cargo [127](#)
 Lock buttons, doors, refer to Locking [33](#)
 Locking
 – adjusting confirmation signal [31](#)
 – from inside [33](#)
 – from outside [30](#)
 – without remote control, refer to Convenient access [36](#)
 Locking and unlocking doors – confirmation signals [31](#)
 – from inside [32](#)
 – from outside [29](#)
 Low-beam headlamps [99](#)
 – automatic [99](#)
 Lower back support, refer to Lumbar support [46](#)
 Luggage compartment lid [33](#)
 – convenient access [37](#)
 – emergency operation, refer to Opening manually [33](#)
 – emergency release [34](#)
 – locking or unlocking separately [34](#)
 – opening from inside [33](#)
 – opening from outside [33](#)
 – opening manually [33](#)
 – remote control [31](#)

Luggage rack, refer to Roof-mounted luggage rack [128](#)
 Lumbar support [46](#)

M

M+S tires, refer to Winter tires [220](#)
 Maintenance, refer to Service Booklet
 Maintenance system [227](#)
 Malfunction
 – luggage compartment lid [33](#)
 – tires [92](#)
 Malfunction warnings, refer to Check Control [83](#)
 Manual
 – BMW Teleservice Call [205](#)
 Manual car wash [230](#)
 "Manual" on the radio [167](#)
 Manual operation
 – door lock [32](#)
 – driver's door [32](#)
 – fuel filler door [214](#)
 – glass roof [40](#)
 – luggage compartment lid [33](#)
 – transmission lock [64](#)
 Manual transmission [61](#)
 – tow-starting [245](#)
 Map
 – changing scale [151](#)
 – destination entry [141](#)
 "Map direction of travel" [151](#)
 "Map facing north" [151](#)
 Master key, refer to Remote control [28](#)
 Maximum cooling [105](#)
 Maximum speed
 – with winter tires [220](#)
 "M DKG DriveLogic" [54](#)
 MDM, refer to M Dynamic Mode [88](#)
 MDrive [54](#)

M dual clutch transmission
with Drivelogic 62
– kick-down 63
– Launch Control 67
– neutral 63
– reverse gear 63
– sequential mode 63
– Shift Lights 66
– shiftlock 63
– tow-starting 245
– unlocking transmission lock manually 64
"M Dynamic Mode" 89
M Dynamic Mode MDM 88
– indicator lamp 89
Measurements, refer to
Dimensions 249
Memory, refer to Seat and
mirror memory 49
M Engine Dynamics
Control 68
MENU button 16
Menus
– Control Display 17
Menus, refer to iDrive 16
Message list, traffic
information 154
Microfilter
– BMW Maintenance
System 227
– for automatic climate
control 107
Microfilter/activated-charcoal
filter
– BMW Maintenance
System 227
Microphone
– telephone 14
– voice input 14
Mirror dimming feature 52
Mirrors 51
– automatic curb monitor 52
– exterior mirrors 51
– heating 52
– interior rearview mirror 52
– memory, refer to Seat and
mirror memory 49
"Missed calls" 196
Missed calls 196

M Mobility Set 237
Mobile phone
– accepted calls 196
– adjusting volume 193
– calling 195
– ending call 195
– installation location, refer to
Center armrest 113
– missed calls 196
– operation via iDrive 193
– redialing 196
– refer to separate Owner's
Manual
– Top 8 196
– touch tone dialing 198
Mobile phone, installation
location, refer to Center
armrest 113
Mobile phone, refer to the
separate Owner's Manual
Modifications, technical, refer
to For your own safety 5
Monitor, refer to iDrive
controls 16
Monitoring system for tire
pressures, refer to Flat Tire
Monitor 90
"Monitor on / off" 53
Most recent mobile phone
numbers 196
MP3, refer to Compressed
audio files 175
"M settings" 54, 55
Multifunctional steering
wheel, refer to Buttons on
the steering wheel 11
Multifunction switch
– refer to Turn signals/
headlamp flasher 68
– refer to Wiper system 69
Multimedia screen, refer to
iDrive 16
Music tracks, refer to
Tracks 176
"Mute on / off" 53
N
"Navigation" 136, 142

Navigation announcements,
refer to Switching voice
instructions on/off 152
Navigation drive, location 134
Navigation DVD 134
– drive 162
Navigation system 134
– address book 144
– changing a route 153
– destination entry 136
– destination guidance in
assistance window 134
– destination list 143
– displaying current
position 157
– entering a destination
manually 136, 140
– last destinations 143
– navigation DVD 134
– opening 136
– route display 150
– route list 152
– searching for a special
destination 142
– selecting destination using
information 142
– selecting destination via
map 141
– selecting route criteria 147
– starting destination
guidance 149
– switching off, refer to
Terminating/continuing
destination guidance 149
– terminating/continuing
destination guidance 149
– voice instructions 152
– volume adjustment 153
"Navigation voice
instructions" 135
"Navigation voice
instructions" via buttons on
the steering wheel 53
Neck support, refer to Head
restraints 47
Nets, refer to Storage
compartments 113
Neutral 63

"New address" in navigation [145](#)
 "New destination" [137](#), [141](#)
 "New route" [153](#)
 New tires [219](#)
 "Next entertainment source" [53](#)
 "Normal" [68](#)
 "Normal" with EDC [90](#)
 North-facing map [151](#)
 Nozzles [103](#)
 Number of cylinders, refer to Engine data [248](#)
 Nylon rope, refer to Tow rope [245](#)

O

OBD socket, refer to Socket for On-Board Diagnosis [228](#)
 Octane ratings, refer to Fuel specifications [215](#)
 Odometer [73](#)
 Oil, refer to Engine oil [223](#)
 Oil consumption [223](#)
 Oil level [223](#)
 Old batteries, refer to Disposal [239](#)
 "On a new destination" in navigation [143](#)
 "Onboard info" [75](#)
 Onboard tool kit [233](#)
 "On destination" [143](#)
 "On location" [143](#)
 Opening and closing
 – convenient access [36](#)
 – from inside [32](#)
 – from outside [29](#)
 – using the door lock [32](#)
 – via the remote control [29](#)

Operation by voice for mobile phone [199](#)
 – adjusting volume [200](#)
 – canceling [199](#)
 – correcting phone number [200](#)
 – dialing phone number [200](#)
 – placing a call [200](#)
 – redialing [200](#)
 – voice commands [199](#)
 – voice phone book [200](#)
 "Options" [207](#), [208](#)
 Orientation menu, refer to Start menu [17](#)
 Outlets
 – refer to Ventilation [106](#)
 Output, refer to Engine data [248](#)
 Outside-air mode
 – automatic climate control [105](#)
 Outside temperature display [73](#)
 – changing units of measure [77](#)
 – in computer [77](#)
 Outside temperature warning [73](#)
 Overheated engine, refer to Coolant temperature [74](#)

P

Paintwork care [230](#)
 Park assistant, refer to Park Distance Control [87](#)
 Park Distance Control PDC [87](#)
 "Parked car operation" [107](#)
 "Parked car ventilation" [107](#)
 Parked car ventilation [107](#)
 – activating switch-on times [108](#)
 – preselecting switch-on times [107](#)
 – switching on and off directly [107](#)
 Parking
 – vehicle [60](#)
 Parking aid, refer to Park Distance Control PDC [87](#)
 Parking brake [61](#)
 – indicator lamp [61](#)
 Parking lamps [99](#)
 Parking lamps/low beams [99](#)
 Passenger-side mirror tilt function [52](#)
 "Pathway lighting" [100](#)
 Pathway lighting [100](#)
 "PDC" [87](#)
 Personal Profile [28](#)
 "Perspective" [151](#)
 Phone book [193](#)
 Phone numbers
 – deleting from phone book [197](#)
 – dialing [195](#)
 – most recent numbers [196](#)
 – selecting in phone book [196](#)
 – Top 8 [196](#)
 Pinch protection system
 – glass roof, electric [40](#)
 – windows [39](#)
 Placing a call, refer to telephone owner's manual
 "Play" for satellite radio [173](#)
 Polish [231](#)
 Pollen
 – refer to Microfilter/activated-charcoal filter for automatic climate control [107](#)
 Position
 – displaying [157](#)
 – saving, refer to Storing current position [145](#)
 "POWER" [54](#), [55](#)
 Power failure [239](#)
 Power windows [38](#)
 Power windows, refer to Windows [38](#)
 "Presets", displaying with the radio [166](#)
 "Presets" for satellite radio [173](#)
 Pressure, tires [216](#)
 Pressure monitoring, tires [90](#)
 – Flat Tire Monitor [90](#)

Pressure monitoring of tires, refer to Tire Pressure Monitor TPM [92](#)
Programmable buttons on the steering wheel [11](#)
Programmable memory keys [21](#)
Protection function, refer to Pinch protection system
– glass roof, electric [40](#)
– windows [39](#)
Providing medical assistance, refer to First aid pouch [242](#)
Puncture
– Flat Tire Monitor [90](#)

R

Radio

– autostore [167](#)
– controls [162](#)
– High Definition Radio [169](#)
– listening to stations [166](#)
– sampling stations [167](#)
– satellite radio [172](#)
– selecting a waveband [162](#), [166](#)
– selecting the frequency manually [167](#)
– station search [167](#)
– stations with best reception [167](#)
– storing stations [168](#)
– switching on/off [162](#)
– tone control [163](#)
– volume [163](#)
Radio-operated key, refer to Remote control [28](#)
Radio position, refer to Radio readiness [59](#)
Radio readiness [59](#)
– switched off [60](#)
– switched on [59](#)
Rain sensor [69](#)
"Random", refer to Random play [178](#)
"Random all" for audio mode [179](#)

"Random directory" for audio mode [179](#)
Random play [178](#)
"RDS" Radio Data System [169](#)
Reading lamps [102](#)
Rear lamps, refer to Tail lamps [235](#)
– replacing bulb [235](#)
Rear seats
– adjusting head restraints [48](#)
– folding down backrests [116](#)
Rear turn signals
– replacing bulb [235](#)
Rear ventilation [107](#)
Rearview mirror, refer to Mirrors [51](#)
Rear window defroster [106](#)
Rear window roller blind, refer to Roller sun blinds [112](#)
"Received calls" [196](#)
Receiving level of mobile phone, refer to Status information [20](#)
Recirculated-air mode [105](#)
Recirculation of air, refer to Recirculated-air mode [105](#)
Reclining seat, refer to Backrest [46](#)
Recording times, refer to Stopwatch [85](#)
"Redial" on the mobile phone [196](#)
Refueling [214](#)
Releasing
– hood [222](#)
Remaining distance, refer to Cruising range [75](#)
Remote control [28](#)
– battery renewal [38](#)
– convenient access [36](#)
– garage door opener [109](#)
– luggage compartment lid [31](#)
– malfunction [31](#), [37](#)
– removing from the ignition lock [59](#)
– service data [227](#)
"Repeat directory" for audio mode [178](#)

"Repeat" for audio mode [178](#)
"Repeat track" for audio mode [178](#)
Replacement remote control [28](#)
Replacing bulbs, refer to Lamps and bulbs [233](#)
Replacing tires [219](#)
Replacing tires, refer to New wheels and tires [219](#)
Reporting safety defects [6](#)
Reserve warning, refer to Fuel gauge [74](#)
"Reset" [91](#), [93](#)
– tone settings [165](#)
Reset, refer to Resetting tone settings [165](#)
"Reset" for stopwatch [85](#)
"Reset to default" for MDrive [54](#)
Residual heat [106](#)
Restraint systems
– for children [57](#)
– refer to Safety belts [50](#)
Retractable hardtop [41](#)
– convenient operation [30](#)
– opening and closing [42](#)
– remote control [30](#)
Reverse
– CD changer [179](#)
– CD player [179](#)
Reverse gear [63](#)
– manual transmission [62](#)
Road map [151](#)
"Roadside Assistance" [204](#)
Roadside Assistance [204](#), [241](#)
Roadside parking lamps [101](#)
Roadworthiness test, refer to Service requirements [78](#)
Roller sun blinds [112](#)
Rollover protection system, convertible [97](#)
– resetting [97](#)
Roof load capacity [251](#)
Roof-mounted luggage rack [128](#)
Rope, refer to Tow-starting, towing away [245](#)

- Rotary/pushbutton, refer to
 - iDrive [16](#)
- Route [147](#)
 - arrow display [150](#)
 - changing [153](#)
 - display [150](#)
 - displaying streets and towns/cities [152](#)
 - displaying town [152](#)
 - list [152](#)
 - map display [151](#)
 - selecting [147](#)
 - selecting criteria [147](#)

S

- Safety-belt height adjustment [50](#)
- Safety belts [50](#)
 - belt hand-over [51](#)
 - damage [50](#)
 - indicator/warning lamp [50](#)
 - reminder [50](#)
 - sitting safely [45](#)
- Safety systems
 - airbags [95](#)
 - Antilock Brake System ABS [88](#)
 - brake system [88](#)
 - driving stability control systems [88](#)
 - Dynamic Stability Control DSC [88](#)
 - rollover protection system, convertible [97](#)
 - safety belts [50](#)
- "SAT" [162](#), [172](#)
- Satellite radio [172](#)
 - displaying additional information [173](#)
 - enabling [172](#)
 - selecting channel [173](#)
 - storing channel [173](#)
- "Scan"
 - sampling radio stations [167](#)
 - sampling tracks on CD [177](#)

- Scan
 - CD changer [177](#)
 - CD player [177](#)
 - radio [167](#)
- "Scan all" for audio mode [177](#)
- "Scan directory" for audio mode [177](#)
- Screen, refer to iDrive controls [16](#)
- Screw thread for tow fitting [244](#)
- SDARS, refer to Satellite radio [172](#)
- Sealant, filling [238](#)
- Seat adjustment
 - electric [46](#)
 - mechanical [46](#)
- Seat and mirror memory [49](#)
- Seat belt reminder, refer to 'Fasten safety belts' reminder [50](#)
- Seat heating [48](#)
- Seats [45](#)
 - adjusting electrically [46](#)
 - adjusting the seats [46](#)
 - heating [48](#)
 - memory, refer to Seat and mirror memory [49](#)
 - saving a setting, refer to Seat and mirror memory [49](#)
 - sitting safely [45](#)
- Securing cargo [118](#), [120](#)
- Securing the vehicle
 - from inside [32](#)
 - from outside [29](#)
- "Select as destination" [143](#), [207](#)
- "Select current speed" [85](#)
- Selecting a country for navigation [137](#)
- Selecting an audio source [162](#)
- Selecting menu items [19](#)
- Selecting new scale for navigation [151](#)
- Selector lever positions [62](#)
- Sequential M Gearbox with Drivelogic
 - Drivelogic drive programs [65](#)
- Sequential mode [63](#)

- Service, refer to Roadside Assistance [241](#)
- Service car, refer to Roadside Assistance [241](#)
- Service data in the remote control [227](#)
- "Service Info" [79](#), [205](#), [225](#)
- Service Interval Display, refer to Condition Based Service CBS [227](#)
- "Service Request" [198](#), [205](#)
- Service requirement display, refer to Condition Based Service CBS [227](#)
- "Service requirements" [79](#), [205](#), [225](#)
- Service requirements [78](#)
- "Servotronic" [54](#)
- "Set date" [82](#)
- "Set time" [81](#)
- "Settings" [209](#)
- Settings
 - changing settings on the Control Display [85](#)
 - clock, 12h/24h format [82](#)
 - configuring, refer to MDrive [54](#)
 - date format [82](#)
 - language [85](#)
- Settings and information [77](#)
- "Settings" for MDrive [54](#), [55](#)
- "Settings" for unlocking [30](#)
- Settings menu, refer to i menu [17](#)
- Setting times, refer to Preselecting switch-on times [107](#)
- Shifting [64](#)
- Shifting gears
 - manual transmission [61](#)
- Shift lever [62](#)
- Shift Lights [66](#)
- "Shift lights" [54](#)
- Shiftlock [63](#)
- Shift paddles on steering wheel [64](#)
- Shift-up display, refer to Shift Lights [66](#)

- Shock absorber control, refer to Electronic Damper Control EDC [90](#)
- Short commands for the voice command system [252](#)
- Shortest route in navigation, refer to Selecting route [147](#)
- "Short route" in navigation [147](#)
- "Show current position" [142](#)
- "Show destination position" [142](#)
- Shuffled, refer to Random
 - CD changer [178](#)
 - CD player [178](#)
- Side airbags [95](#)
- Side windows, refer to Windows [38](#)
- Signal horn, refer to Horn [10](#), [11](#)
- Sitting safely [45](#)
 - with airbags [45](#)
 - with head restraint [45](#)
 - with safety belts [45](#)
- Ski bag [118](#)
- Ski bag for convertible, refer to Through-loading opening with integrated transport bag [119](#)
- Sliding/tilt sunroof, refer to Glass roof, electric [39](#)
- Slot for remote control [59](#)
- Smokers' package, refer to Ashtray [115](#)
- Snap-in adapter [201](#)
- Snap-in adapter, refer to Center armrest storage compartment [113](#)
- Snow chains [221](#)
- Socket, On-Board Diagnosis OBD [228](#)
- Socket, refer to Connecting electrical appliances [115](#)
- Song search, refer to Playing a track [177](#)
- SOS, refer to Sending an Emergency Request [241](#)
- Sound output for entertainment on/off [162](#)
- Spare fuses, [239](#)
- Spare fuses, refer to Fuses [239](#)
- Speaking, refer to Voice instructions from navigation system [152](#)
- Speed
 - with winter tires [220](#)
- Speed-dependent volume control [163](#)
- Speed limit [84](#)
- Speed limit warning, refer to Speed limit [84](#)
- Speedometer [12](#)
- "Speed volume", refer to Tone control [164](#)
- "Sport" [68](#)
- "Sport Plus" [68](#)
- "Sport" with EDC [90](#)
- Spray nozzles, refer to Cleaning windshield and headlamps [70](#)
- Stability control, refer to Driving stability control systems [88](#)
- Start/stop button [59](#)
 - starting the engine [60](#)
 - switching off the engine [60](#)
- "Start guidance" [139](#)
- Starting, refer to Starting the engine [60](#)
- Starting assistance, refer to Jump starting [242](#)
- Starting difficulties
 - jump starting [242](#)
- Starting the engine
 - start/stop button [59](#)
- Start menu [17](#)
- "Start service" [204](#)
- "Start service" for BMW Assist [207](#)
- "State / Province" in destination entry [137](#)
- Station
 - refer to Radio [166](#)
- "Status" [79](#)
- Status of this Owner's Manual at time of printing [5](#)
- Steam jet [229](#), [230](#)
- Steering wheel [52](#)
 - adjustment [52](#)
 - buttons on steering wheel [11](#)
 - lock [59](#)
 - locking with convenient access [37](#)
 - MDrive button [54](#)
 - shift paddles [64](#)
- "Steering wheel buttons" [53](#)
- Steering wheel buttons, refer to Shift paddles [64](#)
- "Stopwatch" [85](#)
- Stopwatch [85](#)
- Storage [232](#)
- Storage compartments [113](#)
- Storage nets [117](#)
- "Store" for satellite radio [174](#)
- "Store in address book" in navigation [145](#)
- "Store" on the radio [168](#)
- Storing current position [145](#)
- Storing radio stations [168](#)
- Storing seat positions, refer to Seat and mirror memory [49](#)
- Storing tires [220](#)
- Stowage, refer to Storage compartments [113](#)
- "Street" in destination entry [139](#)
- Summer tires, refer to Wheels and tires [216](#)
- Surface ice, refer to Outside temperature warning [73](#)
- "Surround Settings", refer to Tone control [164](#)
- Switches, refer to Cockpit [10](#)
- Switching off
 - engine [60](#)
- Switching on
 - audio [162](#)
 - CD changer [162](#)
 - CD player [162](#)
 - radio [162](#)
- Switching on the hour signal [81](#)
- Switching the cooling function on and off [106](#)

Switch-on times of parked car ventilation, preselecting [107](#)
 Symbols [4](#)
 – navigation system [156](#)
 – status information [20](#)
 – traffic info for navigation system [153](#)

T

Tachometer [73](#)
 Tail lamps [235](#)
 – replacing bulb [235](#)
 Tank contents, refer to Capacities [251](#)
 Technical data [248](#)
 – capacities [251](#)
 – dimensions [249](#)
 Technical modifications, refer to For your own safety [5](#)
 Telematics, refer to BMW TeleServices, BMW Assist [203](#)
 Telephone
 – installation location, refer to Center armrest [113](#)
 – refer to separate Owner's Manual
 Telephone, refer to Mobile phone [188](#)
 "Telephone list" [53](#)
 Temperature
 – automatic climate control [104](#)
 – changing unit of measure [77](#)
 – coolant, refer to Coolant temperature [74](#)
 Temperature display
 – outside temperature [73](#)
 – outside temperature warning [73](#)
 – setting the units [77](#)
 Tempomat, refer to Cruise control [70](#)
 Tensioning straps, refer to Securing cargo [127](#)
 "Text language" [86](#)
 "Theater" for Tone control [164](#)

The individual vehicle [5](#)
 Third brake lamp, refer to Center brake lamp [237](#)
 Through-loading opening with integrated transport bag [119](#)
 Through-loading system [116](#)
 Tilt alarm sensor [36](#)
 Tilt function, passenger-side mirror [52](#)
 "Time" [81](#)
 "Time / Date" [81](#), [82](#)
 "Time format" [82](#)
 Timer, refer to Preselecting switch-on times [107](#)
 "Timer 2" for parked car ventilation [108](#)
 "Timer 1" for parked car ventilation [108](#)
 Tire inflation pressure [216](#)
 – loss [92](#)
 Tire pressure monitoring, refer to Flat Tire Monitor [90](#)
 Tire Pressure Monitor TPM [92](#)
 – resetting the system [93](#)
 – system limitations [92](#)
 – warning lamp [94](#)
 Tire puncture, refer to Flat Tire Monitor [92](#)
 Tire Quality Grading [218](#)

Tires
 – age [218](#)
 – air loss [94](#)
 – breaking in [124](#)
 – changing, refer to Changing wheels [239](#)
 – condition [219](#)
 – damage [219](#)
 – inflation pressure [216](#)
 – labels [218](#)
 – minimum tread depth [219](#)
 – new wheels and tires [219](#)
 – pressure monitoring, refer to Flat Tire Monitor [90](#)
 – pressure monitoring, refer to Tire Pressure Monitor TPM [92](#)
 – puncture [92](#)
 – replacing [219](#)
 – size [218](#)
 – storage [220](#)
 – tread depth [219](#)
 – wear indicators, refer to Minimum tread depth [219](#)
 – wheel/tire combination, refer to Correct wheels and tires [220](#)
 – winter tires [220](#)
 TMC station, refer to Traffic information [153](#)
 "Tone" [163](#)
 Tone in audio mode
 – adjusting [163](#)
 – middle setting [165](#)
 Tools, refer to Onboard tool kit [233](#)
 Top, refer to Retractable hardtop [41](#)
 "Top 8" for mobile phone [196](#)
 Torque, refer to Engine data [248](#)
 Touch tone dialing [198](#)
 Tow bar [244](#)
 Tow fitting [244](#)
 – screw thread [244](#)
 Tow fittings for tow-starting and towing away [244](#)

Towing [243](#)
– with manual transmission [244](#)
– with M dual clutch transmission [244](#)
Towing and tow-starting [243](#)
Towing methods [244](#)
Town/city for destination [137](#)
"Town / City" in destination entry [137](#)
Tow rope [245](#)
Tow-starting [243](#), [245](#)
"TPM" [93](#)
TPM, refer to Tire Pressure Monitor [92](#)
Tracks
– random play sequence [178](#)
– sampling, Scan [177](#)
– searching for [177](#)
Traction control, refer to Dynamic Stability Control DSC [88](#)
Traffic information for navigation
– calling up [154](#)
– display on route map [155](#)
– during destination guidance [156](#)
– switching on/off [153](#)
– symbols [156](#)
"Traffic Info settings" [154](#)
Traffic jam
– displaying traffic information [153](#)
– driving around [156](#)
Transmission
– Drivelogic [65](#)
– Launch Control [67](#)
– manual transmission [61](#)
– reverse gear [63](#)
– Shift Lights [66](#)
– unlocking transmission lock manually [64](#)
Transmission lock, unlocking manually [64](#)
Transporting children safely [57](#)
Transport securing devices, refer to Securing cargo [127](#)

Tread depth, refer to Minimum tire tread [219](#)
Treble, refer to Treble and bass [163](#)
Treble, tone control [163](#)
"Trip computer" [76](#)
Trip computer [76](#)
Trip-distance counter, refer to Trip odometer [73](#)
"Triple turn signal" [69](#)
Triple turn signal activation [68](#)
Trip odometer [73](#)
Trunk lid, refer to Luggage compartment lid [33](#)
Turning circle, refer to Dimensions [249](#)
Turn signal indicators
– indicator/warning lamp [12](#)
– triple turn signal [68](#)
Turn signals [68](#)
Tying down loads, refer to Cargo loading [127](#)

U

"Unchanged" [54](#), [66](#)
Uniform Tire Quality Grading/UTQR [218](#)
"Units" [77](#)
Units
– average consumption [77](#)
– temperature [77](#)
Universal garage door opener, refer to Integrated universal remote control [109](#)
Universal mobile phone preparation package, refer to separate Owner's Manual
Universal remote control [109](#)
Unlatching, refer to Unlocking [36](#)
"Unlock button" [30](#)
Unlocking
– from inside [33](#)
– from outside [30](#)
– luggage compartment lid [37](#)
– without remote control, refer to Convenient access [36](#)
"Update services" [206](#), [208](#)

USB-audio interface [182](#)
"USB" for audio mode [181](#), [183](#)

V

Vehicle
– battery [239](#)
– breaking in [124](#)
– cargo loading [126](#)
– Identification Number, refer to Engine compartment [223](#)
– measurements, refer to Dimensions [249](#)
– parking [60](#)
– weight [251](#)
"Vehicle / Tires" for unlocking [30](#)
Vehicle jack [239](#)
Vehicle position, refer to Displaying current position [157](#)
Vehicle storage [232](#)
Ventilation [106](#)
– draft-free [107](#)
– in the rear [107](#)
Ventilation, refer to Climate [103](#)
Ventilation while at a standstill [107](#)
Vents, refer to Ventilation [106](#)
"Vent settings" [104](#)
Voice commands
– overview [23](#)
– short commands [252](#)
Voice instructions from navigation system [152](#)
– muting [53](#), [153](#)
– repeating [53](#), [153](#)
– switching on/off [152](#)
– volume [153](#)
Voice phone book [200](#)

Volume [162](#)

- audio sources [162](#)
- fuel tank, refer to Capacities [251](#)
- mobile phone [193](#)
- speed-dependent control [163](#)
- voice instructions [153](#)

Volume distribution

- front/rear [163](#)
- left/right [163](#)

W

Warning and indicator lamps [13](#)

Warning messages, refer to Check Control [83](#)

Warning triangle [242](#)

Washer fluid [70](#)

- content of the reservoir [70](#)

Washer fluid reservoir [70](#)

Waste tray, refer to Ashtray [115](#)

Water on roads, refer to Driving through water [125](#)

Water penetration [229](#), [230](#)

Waveband with the radio [166](#)

Wear indicators in tires, refer to Minimum tread depth [219](#)

Weights [251](#)

Welcome lamps [99](#)

"Welcome light" [100](#)

Wheel/tire combination, refer to Correct wheels and tires [220](#)

Wheelbase, refer to Dimensions [249](#)

Wheels, new [219](#)

Wheels and tires [216](#)

Width, refer to Dimensions [249](#)

Wind deflector [42](#)

Windows [38](#)

- convenient operation [30](#)
- convenient operation with convenient access [37](#)
- opening, closing [38](#)
- pinch protection system [39](#)

Windows, indicator on Control Display [16](#)

Windshield

- cleaning [70](#)

Windshield wash [69](#)

- filling capacity, reservoir [251](#)
- nozzles [70](#)
- reservoir for washer fluid [70](#)
- washer fluid [70](#)

Windshield wiper blades, changing [233](#)

Windshield wipers, refer to Wiper system [69](#)

Winter tires [220](#)

- setting speed limit [85](#)
- storage [220](#)

Wiper blade replacement [233](#)

Wiper system [69](#)

"With highways" in navigation [147](#)

Word-matching principle for navigation [148](#)

Work in the engine compartment [222](#)

Wrench/screwdriver, refer to Onboard tool kit [233](#)

X

Xenon lamps

- replacing bulb [234](#)

Y

Your individual vehicle

- settings, refer to MDrive [54](#)
- settings, refer to Personal Profile [28](#)

More about BMW

bmwusa.com



The Ultimate
Driving Machine

01 41 0 014 962 ue iDrive

